

1 CHARLES M. TEBBUTT, WSBA #47255  
DANIEL C. SNYDER, *pro hac vice*  
2 Law Offices of Charles M. Tebbutt, P.C.  
941 Lawrence St.  
3 Eugene, OR 97401  
Tel. 541.344.3505

4 BRAD J. MOORE, WSBA #21802  
Stritmatter Kessler Whelan  
5 200 Second Avenue West  
6 Seattle, WA 98119  
Tel. 206.448.1777

7 *Additional counsel on signature page*

8 IN THE UNITED STATES DISTRICT COURT  
9 FOR THE EASTERN DISTRICT OF WASHINGTON

10 COMMUNITY ASSOCIATION FOR  
RESTORATION OF THE  
ENVIRONMENT, INC., a Washington  
11 Non-Profit Corporation  
*and*  
12 CENTER FOR FOOD SAFETY, INC.,  
a Washington, D.C. Non-Profit  
13 Corporation,

Plaintiffs,

14 v.

15 COW PALACE, LLC, a Washington  
Limited Liability Company, THE  
16 DOLSEN COMPANIES, a Washington  
Corporation, and THREE D  
17 PROPERTIES, LLC, a Washington  
Limited Liability Company,

18 Defendants.

NO. CV-13-3016-TOR

[PROPOSED] CONSENT DECREE

1 WHEREAS the Plaintiffs, the Community Association for Restoration of the  
2 Environment, Inc., and Center For Food Safety, Inc., initiated the above-captioned  
3 action by filing a Complaint on February 14, 2013, alleging that certain Defendants  
4 had violated the Resource Conservation and Recovery Act, 42 U.S.C. § 6901 *et seq.*,  
5 seeking injunctive and declaratory relief and attorneys and expert witness fees and  
6 costs;

7 WHEREAS the Court entered an Order on January 14, 2015 (ECF No. 320),  
8 finding Defendants Cow Palace, LLC, The Dolsen Companies, and Three D  
9 Properties, LLC, (hereinafter “Defendants”) in violation of the Resource  
10 Conservation and Recovery Act (“RCRA”), 42 U.S.C. § 6901 *et seq.*, by causing or  
11 contributing to an imminent and substantial endangerment to human health and the  
12 environment and by disposing of solid waste in such a manner as to constitute open  
13 dumping;

14 WHEREAS the Plaintiffs have agreed to forego their request for a complete  
15 RCRA Corrective Action study and instead work with Defendants to take immediate  
16 measures to address what Plaintiffs contend are the most significant and likely  
17 sources of contamination and to ensure that the local community is provided access  
18 to safe and clean drinking water;

19 WHEREAS the Parties mutually agree and request that the terms of this  
20 Consent Decree be presented to the United States Environmental Protection Agency

1 (EPA) for incorporation into the March 2013 Administrative Order on Consent  
2 (AOC) between the EPA and Defendants. It is the intent of the Parties that the terms  
3 of this Consent Decree will be incorporated into a new AOC and that EPA be  
4 appointed to oversee implementation of remedial actions set forth in this Consent  
5 Decree, and incorporated into the new AOC, as further explained herein;

6 WHEREAS after consultation with their respective counsel, Plaintiffs and  
7 Defendants (collectively referred to as the “Parties” and singularly as a “Party”)  
8 hereby wish to settle this lawsuit to avoid the risks of further litigation and appeal  
9 and to resolve the controversy between them;

10 NOW, THEREFORE, upon the consent of the Parties, and upon consideration  
11 of the mutual promises contained herein, it is hereby ORDERED, ADJUDGED, and  
12 DECREED as follows:

13 **GENERAL PROVISIONS**

14 1. This Court has jurisdiction over the Parties and the subject matter of this  
15 lawsuit pursuant to 42 U.S.C. § 6972(a) and 28 U.S.C. § 1331. Venue is proper in  
16 this Court pursuant to 42 U.S.C. § 6972(a) and 28 U.S.C. § 1391(b). This Court  
17 shall have continuing jurisdiction over this lawsuit for the purposes of interpretation,  
18 enforcement, and, if necessary, modification of this Consent Decree.

1 2. The undersigned representative for each Party certifies that he/she is fully  
2 authorized by the Party whom he/she represents to enter into the terms and  
3 conditions of this Consent Decree and to legally bind the Party to it.

4 3. This Consent Decree shall apply to and be binding upon the Parties to this  
5 lawsuit and upon all successors and assigns of the Parties. This provision is  
6 intended to require full compliance with this Consent Decree so long as any portion  
7 of the Dairy Facility<sup>1</sup> is used by any person or entity in the course of conducting  
8 dairy operations, including the application of manure. However, nothing herein  
9 shall prevent Defendants from discontinuing their dairy operations, or from  
10 transferring any of the Dairy Facility to other owners for uses other than for dairy  
11 operations; this Consent Decree shall no longer apply to real property that is not  
12 being used for dairy operations or other agriculturally related operations that involve  
13 the application of nitrogen fertilizers. Defendants, or any of their successors or  
14 assigns, may sell the Dairy, or any of the real property upon which the Dairy or its  
15 operations may currently be conducted, without Plaintiffs' consent and without

16  
17 <sup>1</sup> The term "Dairy" or "Dairy Facility" shall refer to those facilities commonly  
18 known as the Cow Palace Dairy, as described in Appendix A of the AOC, as well as  
19 the properties owned or leased by Defendants named herein used by the Dairy for  
20 manure applications.

1 approval of the Court; provided, however, that Defendants provide a copy of the  
2 Consent Decree to new owner and provide written notice to Plaintiffs of the sale  
3 within 30 days of closing.

4 4. This Consent Decree constitutes the final, complete, and exclusive agreement  
5 and understanding of the Parties with respect to the settlement embodied in this  
6 Consent Decree and the subject matter of this lawsuit. The Parties hereby  
7 acknowledge that there are no representations or understandings relating to the  
8 lawsuit or its settlement other than those expressly contained within this Consent  
9 Decree. This Consent Decree expressly supersedes, extinguishes and replaces all  
10 prior stipulations and agreements between the Parties.

11 5. This Consent Decree, and the AOC that incorporates its terms, may not be  
12 modified in any material respect except by explicit written amendment agreed to by  
13 the Parties. Non-material modifications may be made by the Parties upon written  
14 consent.

15 6. This Consent Decree constitutes the full and complete settlement of all claims,  
16 rights, demands, and causes of any action of any kind for Defendants' alleged  
17 violations, through the date of entry of the Consent Decree, that Plaintiffs asserted or  
18 could have asserted against the Defendants in this lawsuit. Plaintiffs hereby release  
19 all such claims and covenant not to sue Defendants in connection with them. This  
20 covenant not to sue in no way releases Defendants from compliance with this

1 Consent Decree or other applicable law. Furthermore, this covenant not to sue shall  
2 in no way limit Plaintiffs' ability to enforce the terms of this Consent Decree, as  
3 incorporated into the new AOC, or any future and previously unalleged violations of  
4 law committed by Defendants.

5 7. Each Party acknowledges and represents that it has relied on the legal advice  
6 of its attorneys, all listed at the end of the Consent Decree, who are the attorneys of  
7 its own choice, and that the terms of this Consent Decree have been completely  
8 explained to the Party by its attorney(s), and that the terms are fully understood and  
9 voluntarily accepted.

10 8. In the event that any part of this Consent Decree is deemed by a court of  
11 competent jurisdiction to be unlawful, void, or for any reason unenforceable, and if  
12 that part is severable from the remainder of the Consent Decree without frustrating  
13 its essential purpose, then the remaining parts of the Consent Decree shall remain  
14 valid, binding, and enforceable.

15 9. If for any reason the Court should decline to approve this Consent Decree in  
16 the form presented, then the Parties agree to continue negotiations in good faith in an  
17 attempt to cure the objection(s) raised by the Court to entry of this Consent Decree.

18 10. This Consent Decree may be signed in counterparts, and such counterpart  
19 signature page shall be given full force and effect.  
20

1 11. The Dairy is presently located at 1631 North Liberty Road, near Granger,  
2 WA. The Dairy meets the federal and state law definitions of a large concentrated  
3 animal feeding operation or “CAFO.”

4 12. In operating the Dairy, Defendants shall abide by this Consent Decree, the  
5 Resource Conservation and Recovery Act, the Federal Water Pollution Control Act  
6 (“Clean Water Act”), the Washington Dairy Nutrient Management Act, RCW 90.64  
7 *et seq.*, and the Dairy’s Nutrient Management Plan (NMP). If any of the terms of  
8 this Consent Decree are stricter than the aforementioned laws, then the terms of the  
9 Consent Decree shall control. If any of these laws are stricter than the terms of the  
10 Consent Decree, either now or in the future, such stricter laws shall apply.

11 Notwithstanding the foregoing, the Parties agree that nothing in this Consent Decree  
12 may be construed to obligate Defendants to violate any law, regulation, or the  
13 current terms of the AOC. In the event of any perceived conflict, the Parties agree to  
14 submit the matter to the dispute resolution process described in paragraph 56.

15 13. Defendants shall update their NMP to reflect the requirements set forth herein  
16 within 45 days of entry of the Consent Decree and provide a copy to Plaintiffs for  
17 review and comment.

18 **OVERSIGHT OF CONSENT DECREE IMPLEMENTATION**

19 14. At the request of the Parties and the Court, and to the extent agreed to by  
20 EPA, EPA shall oversee implementation and enforcement of the terms of the



1 Consent Decree. Further, any and all reports and information required to be  
2 produced to the EPA under the AOC shall hereafter be simultaneously provided to  
3 Plaintiffs' designee(s).

4 **SITE INSPECTIONS AND RECORD KEEPING**

5 15. For the duration of this Consent Decree, EPA shall be allowed to inspect the  
6 Dairy Facility, including any application fields owned, leased, or otherwise  
7 controlled by the Defendants, upon reasonable notice and at reasonably convenient  
8 times. Plaintiffs may designate up to four individuals to accompany EPA on any  
9 such inspection; provided, however, that any such designated individuals shall  
10 possess reasonable scientific or professional credentials so as to provide a  
11 meaningful assessment of Defendants' progress under this Consent Decree.

12 16. Inspections shall be conducted between the hours of 8:00 AM and 6:00 PM on  
13 weekdays, unless otherwise agreed to by the Parties. Plaintiffs' representatives shall  
14 be accompanied at all times by a representative of Defendants' choosing.

15 17. For the duration of this Consent Decree, Defendants agree to make available  
16 to Plaintiffs, at no cost to Plaintiffs, electronic copies of any reports, correspondence,  
17 sampling results, or other documents related to Cow Palace Dairy's Dairy Nutrient  
18 Management Plan, the Administrative Order on Consent ("AOC") between  
19 Defendants and EPA, and any documents generated as part of this Consent Decree.  
20 Defendants may withhold from Plaintiffs documents that are legitimately protected



1 by attorney-client privilege or the attorney work product doctrine. If Defendants  
2 assert that a document is immune from production to Plaintiffs, then Defendants  
3 shall provide to Plaintiffs a privilege log containing a description of the nature of the  
4 document(s) withheld, its author and recipients, its date, the privilege or immunity  
5 asserted, and a description of the content of the document which, without revealing  
6 privileged or protected information, enables Plaintiffs to evaluate whether the  
7 privilege or immunity is being properly asserted.

#### 8 **LAGOON LINING AND MAINTENANCE**

9 18. Defendants hereby agree to double line all lagoons with GCL liners and a 40  
10 mil synthetic liner as set forth in the April 20, 2015 Dairy Lagoon Work Plan,  
11 attached hereto as Exhibit 1, or as may reasonably be modified through the  
12 discussions of Plaintiffs, Defendants, and the EPA. The lining shall occur in the  
13 following lagoons no later than the date set forth for each lagoon. The name for  
14 each lagoon corresponds to that on the Lagoon Review Report submitted to EPA  
15 under the AOC on August 8, 2013.

- 16 a. Settling Basin A, by no later than December 31, 2015;  
17 b. Settling Basin B, by no later than December 31, 2015;  
18 c. Catch Basin NW, by no later than December 31, 2015;  
19 d. Lagoon 1, by no later than December 31, 2016;  
20 e. Lagoon 4, by no later than December 31, 2016;

1 f. Lagoon 2, by no later than December 31, 2017;

2 g. Lagoon 3, by no later than December 31, 2017;

3 h. Safety Debris Basin, by no later than December 1, 2018;

4 The Parties acknowledge that the above time-commitments are subject to the  
5 availability of materials, unanticipated weather or site conditions, and EPA's ability  
6 to review and approve the lagoon installation plans in a timely manner. Should the  
7 EPA fail to timely review and approve the lagoon installation plans, and/or should  
8 unanticipated weather or site conditions or the unavailability of materials cause  
9 delay, the Parties agree to reconvene their discussions and agree to new date(s) or to  
10 otherwise submit this matter to the dispute resolution process set forth in Paragraph  
11 56. Notwithstanding the foregoing, Defendants hereby covenant to use their best  
12 efforts and to hire such consultants and contractors as may be reasonably necessary  
13 to accomplish the installations on the dates set forth above.

14 19. Catch Basin NE is not included in the lining plan because it is slated for  
15 elimination and abandonment. Such elimination and abandonment shall be  
16 completed prior to December 31, 2016, and shall be performed consistent with the  
17 requirements of NRCS Conservation Standard Practice No. 360.

18 20. Defendants shall provide to Plaintiffs a copy of the Pre-Final (90%) Design  
19 addressed in Section 6.1 of Exhibit 1 within three (3) business days after such  
20

1 document is provided to EPA. Plaintiffs may provide comments to Defendants and  
2 EPA within 30 days.

3 21. At least 60 days prior to beginning work on any liner installation, Defendants  
4 shall provide to Plaintiffs an installation plan and QAPP for review and comment.  
5 Plaintiffs may provide comments to Defendants and EPA within 30 days

6 22. To the extent EPA representatives are not present during liner installation,  
7 Plaintiffs may have two representatives present as observers at the Dairy during each  
8 distinct phase of liner installation: draw down and pump out; re-grading; addition  
9 and compaction of fill material; installation of liner materials. Such representatives  
10 shall have applicable scientific or professional qualifications to make their review  
11 meaningful and to confirm compliance with the Consent Decree and the Lagoon  
12 Plan. At least 48 hours prior to any such observation, Plaintiffs shall provide written  
13 notice of such intent to observe directly to Cow Palace and its counsel. Such notice  
14 shall include the names of the proposed observers, a description of the observers'  
15 qualifications (to the extent not already known), as well as the start and end time of  
16 the proposed period of observation. The representatives may not remain on site  
17 outside of work hours and must be accompanied by a representative of Defendants at  
18 all times (including being accompanied on and off the property).

19 **GROUNDWATER MONITORING**

1 23. Defendants and Plaintiffs disagree about whether it is reasonable or necessary  
2 to install additional monitoring wells south or southwest of the Dairy Facility, and in  
3 particular south of the Sunnyside Irrigation Canal. Plaintiffs contend that such  
4 monitoring wells are necessary to determine whether, how long, and in what  
5 magnitude Defendants' operations continue to contribute to groundwater  
6 contamination. Defendants contend that the combined provisions of the Consent  
7 Decree and the AOC eliminate any possibility of continuing or future contamination  
8 and are concerned that such downgradient monitoring wells may be impacted by  
9 significant contaminants from other sources. For the purposes of compromise,  
10 Defendants agree to fund the installation of a grid of 14 new monitoring wells. Such  
11 monitoring wells shall be installed as soon as practicable. The locations of the new  
12 wells are depicted in the map attached hereto as Exhibit 2 and are subject to location  
13 refinement as site conditions or property rights require. The Parties shall consult  
14 and agree on the new well locations. Plaintiffs shall have access to the actual  
15 monitoring well installation to ensure that all wells are installed as agreed.  
16 Defendants shall sample the new monitoring wells under the same terms and at the  
17 same time as sampling occurs under the AOC for the other monitoring wells  
18 installed on Defendants' property, and at least once per quarter during the term of  
19 this Consent Decree regardless of whether the AOC continues. At least 60 days  
20 prior to beginning work on monitoring well installation, Defendants shall provide to

1 Plaintiffs an installation plan and QAPP for review and comment. Plaintiffs shall  
2 provide comments within 30 days and the Parties must agree on the QAPP in writing  
3 at least 10 days before construction of the wells is allowed to commence.

4 24. All aspects of Defendants' obligations with respect to groundwater  
5 monitoring, as set forth above in Paragraph 23, are subject to review, approval, and  
6 modification by EPA under the AOC.

7 25. Defendants agree to provide to Plaintiffs in electronic form the laboratory  
8 results of each groundwater sampling event at the same time the results are provided  
9 to EPA.

10 **CENTRIFUGE MANURE SEPARATOR**

11 26. As part of their commitment to reducing the nutrients applied to their farming  
12 operations, Defendants have installed and shall maintain a centrifuge manure  
13 separator at the Dairy. The Parties anticipate that operation of a centrifuge separator  
14 will reduce the nitrogen and phosphorus content of the Dairy's liquid manure.

15 27. The centrifuge separator shall operate "in-line" with the Dairy's existing  
16 manure separator system. "In-line" means that manure shall first be processed by  
17 the Dairy's pre-existing manure separator, then processed in the centrifuge separator,  
18 removing additional solids from the liquid manure. This procedure shall remain in  
19 place except for brief periods in which the centrifuge may be undergoing repair or  
20 maintenance.

1 28. Defendants shall provide Plaintiffs with data concerning nutrient removal and  
2 information about how the nutrients are to be used. Such information shall be  
3 provided to Plaintiffs within 90 days of entry of this Consent Decree and as part of  
4 the annual information required to be provided to Plaintiffs.

5 **UNDERGROUND CONVEYANCE INSPECTION**

6 29. Defendants agree to inspect all underground conveyance systems (piping,  
7 joints, manholes, inlet structures and discharge structures). Inspection shall consist  
8 of pressure testing of all transmission lines and/or video inspection and  
9 documentation of all underground structures. Results of all such inspections shall be  
10 provided to Plaintiffs' designated representative(s) within five (5) business days of  
11 completion. Leaks or improper piping shall be fixed so that all wastes are  
12 appropriately directed to lined lagoons.

13 **COW PENS**

14 30. No later than December 31, 2016, Defendants shall install concrete aprons  
15 along all water troughs within all the cow pens at the Dairy, with appropriate piping  
16 or diversion that redirects all collected wastewater to the Dairy's lagoon system.  
17 Aprons shall be constructed to generally applicable industry standards, with no less  
18 than ten (10) feet of concrete between the outside edge of the trough to the edge of  
19 the apron.  
20

1 31. No later than October 15, 2016, Defendants shall also install concrete at the  
2 terminal end of the alleyways in all of the cow pens at the Dairy, with appropriate  
3 piping or diversion that redirects all collected wastewater to the Dairy's lagoon  
4 system. Such concrete shall be no less than 100 square feet in size, the final size to  
5 be determined after consultation with the Plaintiffs, and shall reasonably cover the  
6 historical high-traffic or bottlenecked areas at the terminal ends of the alleyways.  
7 The concrete shall be repaired and/or replaced as the herd's travel patterns may  
8 dictate.

9 32. Effective upon entry of this Consent Decree, Cow Palace shall implement a  
10 protocol of regularly inspecting for and re-grading all low-lying or wet spots within  
11 all the cow pens at the Dairy. Upon identification of any ponding of water Cow  
12 Palace shall promptly take reasonable steps to alleviate such ponding, including, as  
13 may be appropriate, vacuuming and removing any ponded water from the pens. The  
14 re-grading process shall slope any low-lying or wet spots such that they no longer  
15 collect, or have the potential to collect, runoff from the cow pens. Such inspection  
16 and re-grade shall occur at least monthly as weather conditions allow, and as  
17 practical in months where weather conditions make re-grading problematic.

18 33. Manure shall be scraped in the cow pens at least weekly and any accumulated  
19 piles removed at least monthly.

20 **SILAGE AREA**



1 34. Effective upon entry of this Consent Decree, Cow Palace shall ensure that its  
2 Silage Area is located entirely on an impervious surface. For purposes of this  
3 section, the storage of natural products (hay, triticale, for example, but not corn) that  
4 are expected to be incorporated into silage are not considered located in the Silage  
5 Area, but rather are stored in synthetic AgBags in an area adjacent to the Silage  
6 Area. So long as the natural products are stored in synthetic AgBags, or containers  
7 of similar construction that prevent regular contact with soils, such natural products  
8 need not be maintained on an impervious surface. AgBags shall be positioned so  
9 that if there is any leachate it will be directed to an asphalt apron where it shall be  
10 collected and conveyed to the lagoons.

#### 11 **COMPOST AREA**

12 35. No later than October 15, 2015, Cow Palace shall implement an Aerated Pile  
13 Pilot Project. Such Pilot Project shall include at least the elements included the  
14 Project Memo attached hereto as Exhibit 3. Upon completion of the Pilot Project, or  
15 by December 31, 2016, whichever is later, Cow Palace shall either: a) implement a  
16 comprehensive controlled aeration system, that measurably accelerates the reduction  
17 of moisture, increases oxygen levels, and provides temperature control; reduce the  
18 acreage of the Compost Operations to 30 acres or less; and conduct all Compost  
19 Operations on a surface with a permeability rating of at least  $1 \times 10^{-4}$  cm/sec, on a  
20 slope of at least 2% leading to an asphalt apron for collection of any leachate or

1 runoff; or b) Cow Palace shall declare the Pilot Project as failed and immediately  
2 resume settlement discussions on this issue with Plaintiffs.

3 **MANURE APPLICATION & FIELD MANAGEMENT**

4 36. Defendants shall ensure that all future applications of liquid and solid manure  
5 to agricultural fields owned, leased, or otherwise controlled by the Defendants are  
6 based upon the nutrient management budget contained in Exhibit 4. The nutrient  
7 budget requires Defendants to determine all future manure application rates based on  
8 residual soil nitrate and phosphorus levels, ensuring that manure is applied in  
9 agronomic quantities and rates as defined herein. Furthermore, the post-harvest  
10 sampling contemplated under this Consent Decree shall be conducted consistent  
11 with the post-harvest sampling requirements of the AOC.

12 37. As required by the AOC, Defendants shall take soil tests in all manure  
13 application fields following the 2015 harvest. To the extent any field that is owned,  
14 leased, or otherwise controlled by the Defendants has been shown, post-harvest, to  
15 have an average of greater than 40 ppm residual nitrate plus ammonium in the top  
16 two feet of the soil column, Defendants shall not apply to such field in 2016 until  
17 and unless the average is shown by subsequent test to be below 40 ppm. Thereafter  
18 Defendants may apply to agronomic rates and in accordance with the nutrient  
19 budget. In addition, for fields with more than 40 ppm phosphorus in the upper foot,  
20 based on a valid sample obtained during the 2015 calendar year, manure may only

1 be applied in a manner that, based upon a nutrient budget, seeks to reduce  
2 phosphorus application to less than 66.66 percent of crop removal. In addition,  
3 fields that exceed any of the numbers listed above shall be considered for planting in  
4 alfalfa during 2016.

5 38. To the extent any field that is owned, leased, or otherwise controlled by the  
6 Defendants which was shown, post-harvest 2016, to have an average of greater than  
7 35 ppm residual nitrate plus ammonium in the top two feet of the soil column,  
8 Defendants shall not apply to such field in 2017 until and unless the average is  
9 shown by subsequent test to be below 35 ppm. Thereafter Defendants may apply to  
10 agronomic rates and in accordance with the nutrient budget. In addition, for fields  
11 with more than 40 ppm phosphorus in the upper foot, based on a valid sample  
12 obtained during the 2017 calendar year, manure may only be applied in a manner  
13 that, based upon a nutrient budget, seeks to reduce phosphorus application to less  
14 than 66.66 percent of crop removal.

15 39. To the extent any field is owned, leased, or otherwise controlled by the  
16 Defendants which has been shown, post-harvest 2017, to have an average of greater  
17 than 30 ppm residual nitrate plus ammonium in the top two feet of the soil column,  
18 Defendants shall not apply to such field in 2018 until and unless the average is  
19 shown by subsequent test to be below 30 ppm. Thereafter Defendants may apply to  
20 agronomic rates and in accordance with the nutrient budget. In addition, for fields

1 with more than 40 ppm phosphorus in the upper foot, based on a valid sample  
2 obtained during the 2018 calendar year, manure may only be applied in a manner  
3 that, based upon a nutrient budget, seeks to reduce phosphorus application to less  
4 than 66.66 percent of crop removal.

5 40. To the extent any field owned, leased, or otherwise controlled by the  
6 Defendants has been shown, post-harvest 2018, to have an average of greater than 25  
7 ppm residual nitrate plus ammonium in the top two feet of the soil column,  
8 Defendants shall not apply to such field in 2019 and thereafter until and unless the  
9 average is shown by subsequent test to be below 25 ppm. Thereafter Defendants  
10 may apply to agronomic rates and in accordance with the nutrient budget. In  
11 addition, for fields with more than 40 ppm phosphorus in the upper foot, based on a  
12 valid sample obtained during the calendar year at issue, manure may only be applied  
13 in a manner that, based upon a nutrient budget, seeks to reduce phosphorus  
14 application to less than 66.66 percent of crop removal until such time as phosphorus  
15 levels are reduced to 40 ppm or less phosphorus in the upper foot of the soil column,  
16 based on a valid sample obtained during the calendar year of planting. Once 40 ppm  
17 is achieved, no applications of manure will be allowed that cause residual  
18 phosphorus levels to once again exceed 40 ppm.

19 41. In addition to the above limitations, if it appears that additional nutrients are  
20 required during the spring/summer growing season to any crop, Cow Palace shall

1 first take tissue samples to determine whether additional nutrients may be applied  
2 agronomically.

3 42. Furthermore, in the event any given field fails to meet the post-harvest nitrate  
4 limit in two consecutive years, then the nutrient budget shall be modified in a  
5 manner designed to consistently reach the post-harvest limit. Plaintiffs shall be  
6 consulted on any such modifications. If the Parties cannot agree to an acceptable  
7 modification prior to March 31st of the year following the second non-compliant  
8 test, then the matter shall be submitted to mediation and/or binding arbitration, at  
9 Cow Palace's expense.

10 43. It is Plaintiffs' position that the limits for application set forth herein are a  
11 compromise intended to achieve significant reduction of ongoing impacts but may  
12 not represent the scientific standards that may be needed to provide full, long-term  
13 environmental protection. Plaintiffs have agreed to limitations set forth herein, in  
14 conjunction with the Clean Water Project, in order to provide immediate relief to  
15 potentially impacted residents while the regulatory agencies address the longer-term  
16 standards necessary to protect human health and the environment.

17 44. Beginning immediately, Cow Palace shall ensure that all liquid manure  
18 applications to its fields are measured by flow meters, and that all application fields  
19 are equipped with at least two moisture sensor stations. The application and  
20 irrigation monitoring will be conducted in accordance with EPA-approved Cow

1 Palace “Irrigation Water Monitoring Quality Assurance Plan”, dated November 20,  
2 2013. Each sensor station shall include a data logger with sensors at 1’, 2’, and 3’ of  
3 depth, as well as a rain gauge. The data shall be transmitted via cell modem to a  
4 web-based software application that presents the data in tabular and graphical form.  
5 The water measurements shall be considered against projected evapotranspiration  
6 and anticipated crop needs, and irrigation recommendations will be made  
7 accordingly for each field, each week, for the entire irrigation season. The sensor  
8 system shall be outfitted with an alarm function that will immediately notify Cow  
9 Palace representatives if the moisture level in the third foot sensor reaches field  
10 capacity. If the third foot in any field reaches field capacity then irrigation shall be  
11 promptly discontinued.

12 45. Defendants shall make available to Plaintiffs copies of all manure  
13 management documents created by the Dairy, including but not limited to, field  
14 application summaries, third-party manure application summaries, soil sampling,  
15 manure sampling, regularly maintained moisture sensor data, handwritten field  
16 application logbooks, crop yield data, tissue sampling data, nutrient budgets, and  
17 nutrient planning and application documents generated by Defendants.

18 **PROVISION OF BOTTLED WATER OR REVERSE OSMOSIS SYSTEM**

19 46. Defendants agree to fund the provision of clean drinking water to eligible  
20 residences identified within the geographical area depicted on Exhibit 5 (“Covered

1 Area”). Eligible residences are those that have a valid test result from their drinking  
2 water source in the prior 5 years showing a nitrate level of 10 ppm or higher and no  
3 reverse osmosis system, and residences that do have a reverse osmosis system but  
4 that have a similarly valid test result showing nitrate level of 60 ppm or higher. This  
5 program is hereafter referred to as the “Clean Drinking Water Project.”

6 47. The Parties hereby agree to have the Clean Drinking Water Project be  
7 administered by a third party, in consultation with CARE. For purposes of funding  
8 such Project, Defendants shall contribute \$3,000 per month for the first three months  
9 of this Consent Decree, and \$2,000 per month thereafter until the Consent Decree is  
10 terminated with respect to nitrates in drinking water. To the extent the contributions  
11 of Defendants and other parties do not cover all of the reasonable costs of the  
12 Project, Defendants agree to contribute additional monies as reasonably requested  
13 and supported by the third party administrator up to a limit of an additional \$25,000  
14 over the course of the Consent Decree.

15 48. The Parties agree that the purpose of the Project is to ensure that all eligible  
16 residences within the Covered Area are provided access to either bottled water or  
17 reverse osmosis systems. Bottled water must be obtained from a reliable  
18 commercial source, and the water must meet all applicable drinking water standards.  
19 Reverse osmosis systems may be installed instead of bottled water but bottled water  
20 must be provided until such systems are in place and functioning. All costs of



1 installation, maintenance and repair of alternative water systems shall be covered, to  
2 the extent funds are available, by the Project.

3 49. Bottled water service and/or reverse osmosis systems shall be offered to any  
4 eligible residence within the Covered Area. The Parties shall jointly propose that  
5 GWAC help facilitate the Project, and that a mutually agreed third party administer  
6 the Project. The specific protocols of the Project shall be determined by the third  
7 party in consultation with CARE, and CARE shall have authority to oversee and  
8 monitor the Project.

9 50. If CARE and the third party agree that the funds from Defendants or any other  
10 sources have fulfilled the purpose of the Project, then CARE and the third party may  
11 utilize any excess funds to supply clean drinking water to such persons or residences  
12 in the Granger/Outlook/Sunnyside area that they believe, in their joint discretion, to  
13 be most impacted by contaminated groundwater. In no event may any excess funds  
14 be refunded to Defendants.

15 51. Defendants' obligation to contribute to the Clean Drinking Water Project shall  
16 terminate only as provided below in paragraph 54(C).

17 **PAYMENT OF ATTORNEYS' FEES, EXPERT WITNESS FEES, AND**

18 **COSTS**

19 52. Within 60 days of entry of this Consent Decree by the Court, Defendants shall  
20 pay an initial amount of Plaintiffs' attorneys' fees, expert witness fees, and costs

1 incurred in association with this lawsuit, in the amount of \$300,000, to the Law  
2 Offices of Charles M. Tebbutt, P.C. Within 60 days such payment, Plaintiffs may  
3 petition the Court for an award of further reasonable attorneys' and expert fees and  
4 costs.

5 53. Defendants also agree to contribute a reasonable and limited sum for fees and  
6 costs that may be incurred in monitoring compliance with this Consent Decree in an  
7 amount not to exceed \$9,000 per year for 2015-2017 and \$4,000 per year thereafter  
8 until termination. Plaintiffs shall submit to Defendants' counsel, no later than  
9 January 30 of each year, an invoice for Plaintiffs' fees and costs related to the  
10 Consent Decree for the prior year. Payment shall be made within 30 days of the date  
11 of the invoice. If there is a dispute about the fees, then such dispute shall be  
12 resolved through the dispute resolution provisions set forth in Paragraph 56.

13 **TERMINATION**

14 54. This Consent Decree shall terminate as follows:

15 A. With the exception of the Clean Drinking Water Project and  
16 phosphorus, this Consent Decree shall terminate five years after entry if Defendants  
17 have complied with all material terms. Compliance with material terms means that  
18 Defendants will have, at a minimum:

19 a. Provided reasonable and timely access to EPA and Plaintiffs  
20 representatives as contemplated in the Consent Decree;

1           b.     Substantially and in good-faith complied with all record-keeping, notice  
2 and document production obligations;

3           c.     Substantially and in good-faith complied with all obligations under the  
4 AOC, including in particular the Immediate Source Control Actions;

5           d.     Timely installed lagoons in a manner consistent with an approved  
6 lagoon plan, and maintained and repaired the lagoons in a manner consistent with  
7 industry standards;

8           e.     Installed, maintained, monitored and reported information from the new  
9 monitoring wells in a manner consistent with their obligations herein;

10          f.     Managed the centrifuge, compost, pens, underground conveyances,  
11 silage, and other dairy operations in a manner consistent with best dairy practices,  
12 the nutrient management plan, and their obligations herein;

13          g.     Substantially complied with their obligations under the Application  
14 Management and Irrigation Water Management Plans, and **strictly** complied with  
15 their duty to **only** apply at agronomic rates, within the nutrient budget, and  
16 exclusively as allowed under this Consent Decree;

17          h.     Consistently achieved post-harvest limits of 25 ppm nitrate average,  
18 including ammonium, in the top two feet, in at least half of their fields, with  
19 demonstrable downward trends in all other fields; and provided that all obligations  
20

1 as they relate to nitrates shall continue to be honored and observed under the Dairy's  
2 nutrient management plan.

3 B. This Consent Decree shall terminate with respect to obligations relating  
4 to phosphorus only when at least 50% of Defendants' fields have tested post-harvest  
5 at or less than 40ppm average in the top two feet of the fields, and with  
6 demonstrable downward trends in all other fields. Notwithstanding the termination  
7 of this Consent Decree, the provisions herein as they relate to phosphorus shall  
8 continue to be honored and observed under the Dairy's Nutrient Management Plan.

9 C. With respect to the Clean Drinking Water Project, and for those  
10 provisions that have not otherwise terminated with respect to the other obligations  
11 set forth in paragraph A, above, this Consent Decree shall terminate only when the  
12 13 "Determinative Wells" test at 10 ppm nitrate for 8 consecutive quarters; or when  
13 the collection of data from all wells shows a consistent downward trend, such that a  
14 reasonable person would conclude that the Dairy is no longer a significant source of  
15 nitrates to groundwater. The 13 Determinative Wells include the following: new  
16 wells 2-8 as shown on Exhibit 2, and YVD wells 8, 9, 10, 15, DC-03, DC-03D. To  
17 the extent the Parties do not agree as to whether or when this Consent Decree shall  
18 terminate, the matter shall be submitted to the dispute resolution process, and if need  
19 be to the Court for hearing and resolution.

20 **INTEGRATION**

1 55. This Consent Decree constitutes the final, complete, and exclusive agreement  
2 and understanding among the Parties with respect to the settlement reflected in this  
3 Consent Decree, and supersedes all prior agreements and understandings among the  
4 Parties related to the subject matter in this Consent Decree.

5 **DISPUTE RESOLUTION**

6 56. In the event of any dispute regarding implementation, interpretation, or  
7 compliance with this Consent Decree, the Parties shall first attempt to informally  
8 resolve that dispute through meetings of the Parties. Any Party may initiate the  
9 informal dispute resolution process by serving written notice of a request for dispute  
10 resolution on the other Party. If no resolution is reached within thirty (30) calendar  
11 days of the date that the notice of a request for dispute resolution is served, then the  
12 Parties may resolve the dispute by filing motions with the Court.

13 **EFFECTIVE DATE**

14 57. The effective date of this Consent Decree shall be the date upon which the  
15 Court enters in the civil docket a copy of this Consent Decree signed by the Court.

16 **FINAL JUDGMENT**

17 58. Upon approval and entry of this Consent Decree by the Court, this Consent  
18 Decree shall constitute a final, non-appealable judgment of the Court under Rules 54  
19 and 58 of the Federal Rules of Civil Procedure.

20 **NOTICES**

1 59. Whenever notice is required to be given or a document is required to be sent  
2 by one Party to another under the terms of this Consent Decree, it shall be directed  
3 to the individuals at the addresses specified below, unless prior notice of a change  
4 has been given to the other Party. A notice is sufficient under this Consent Decree if  
5 it is provided in writing through U.S. mail, hand-delivered, or provided  
6 electronically by e-mail, with e-mail being the first choice for all communications.  
7 If notice is provided via U.S. mail, it shall be considered effective upon the date of  
8 mailing.

9 For Plaintiffs CARE and CFS:

10 Charles M. Tebbutt, Law Offices of Charles M. Tebbutt (e-mail to be  
11 provided), attention: Yakima Valley Dairies Consent Decree)

12 For Defendants:

13 Brendan Monahan, Stokes Lawrence Velikanje Moore & Shore (e-mail to be  
14 provided), attention: Yakima Valley Dairies Consent Decree

15 The Parties shall exchange designated e-mail addresses to be used in accordance  
16 with this Section no later than three (3) business days after entry of this Consent  
17 Decree. Any Party may change either the notice recipient or the address for  
18 providing notices to it by serving the other Parties with a notice setting forth such  
19 new notice recipient or address.

1 WE HEREBY CONSENT to the Entry of this Consent Decree.

2 COMMUNITY ASSOCIATION FOR  
3 RESTORATION OF THE ENVIRONMENT, INC.

4 By: Helen Reddout  
Helen Reddout, President

5 CENTER FOR FOOD SAFETY, INC.,

6 By: \_\_\_\_\_  
George Kimbrell, Senior Attorney

7 **Plaintiffs**

8 COW PALACE, LLC

9 By: R. William Dolsen  
10 R. William Dolsen, Manager

11 THE DOLSEN COMPANIES

12 By: R. William Dolsen  
R. William Dolsen, President

13 THREE D PROPERTIES, LLC

14 By: R. William Dolsen  
15 R. William Dolsen, Manager

16 **Defendants**

17 [IT(CT)] IS SO ORDERED THIS \_\_\_\_\_ Day of May, 2015.

18  
19 \_\_\_\_\_  
THOMAS O. RICE  
United States District Judge



1 WE HEREBY CONSENT to the Entry of this Consent Decree.

2 COMMUNITY ASSOCIATION FOR  
3 RESTORATION OF THE ENVIRONMENT, INC.

4 By: \_\_\_\_\_  
Helen Reddout, President

5 CENTER FOR FOOD SAFETY, INC.,

6 By:  \_\_\_\_\_  
George Kimbrell, Senior Attorney

7 ***Plaintiffs***

8 COW PALACE, LLC

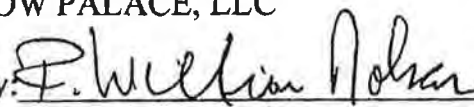
9 By:  \_\_\_\_\_  
10 R. William Dolsen, Manager

11 THE DOLSEN COMPANIES

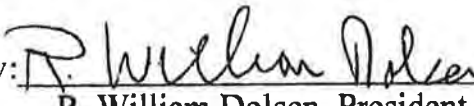
12 By:  \_\_\_\_\_  
R. William Dolsen, President

13 THREE D PROPERTIES, LLC

14 By:  \_\_\_\_\_  
15 R. William Dolsen, Manager

16 ***Defendants***

17 IT [CT1] IS SO ORDERED THIS \_\_\_\_\_ Day of May, 2015.

18  
19 \_\_\_\_\_  
THOMAS O. RICE  
United States District Judge

1 WE HEREBY CONSENT to the Entry of this Consent Decree.

2 COMMUNITY ASSOCIATION FOR  
3 RESTORATION OF THE ENVIRONMENT, INC.

4 By: \_\_\_\_\_  
Helen Reddout, President

5 CENTER FOR FOOD SAFETY, INC.,

6 By: \_\_\_\_\_  
George Kimbrell, Senior Attorney

7 ***Plaintiffs***

8 COW PALACE, LLC

9 By: R. William Dolsen  
10 R. William Dolsen, Manager

11 THE DOLSEN COMPANIES

12 By: R. William Dolsen  
R. William Dolsen, President

13 THREE D PROPERTIES, LLC

14 By: R. William Dolsen  
15 R. William Dolsen, Manager

16 ***Defendants***

17 IT [CTI] IS SO ORDERED THIS \_\_\_\_\_ Day of May, 2015.

18  
19 \_\_\_\_\_  
THOMAS O. RICE  
United States District Judge

1                   Respectfully submitted this 11th day of May, 2015 and effective on the date  
2 entered by the Court.

3 s/ Brad J. Moore  
4 BRAD J. MOORE, WSBA #21802  
5 Stritmatter Kessler Whelan  
6 200 Second Ave. W.  
7 Seattle, WA 98119  
8 Tel. 206.448.1777  
9 E-mail: Brad@stritmatter.com

10 *Local Counsel for Plaintiffs*

s/ Charles M. Tebbutt  
CHARLES M. TEBBUTT  
WSBA #47255  
DANIEL C. SNYDER  
OR Bar No. 105127 (*pro hac vice*)  
Law Offices of Charles M. Tebbutt, P.C.  
941 Lawrence St.  
Eugene, OR 97401  
Tel. 541.344.3505  
E-mail: charlie.tebbuttlaw@gmail.com  
dan.tebbuttlaw@gmail.com

*Counsel for Plaintiffs*

11 s/ Jessica L. Culpepper  
12 JESSICA L. CULPEPPER  
13 NY Bar Member (*pro hac vice*)  
14 Public Justice  
15 1825 K Street NW, Ste. 200  
16 Washington, DC 20006  
17 Tel. 202.797.8600  
18 E-mail: jculpepper@publicjustice.net

*Counsel for Plaintiffs*

19 s/ Toby James Marshall  
20 TOBY J. MARSHALL, WSBA # 32726  
BETH E. TERRELL, WSBA # 26759  
Terrell Marshall Daudt & Willie PLLC  
936 North 34th Street, Suite 300  
Seattle, WA 98103  
206-816-6603  
Emails: bterrell@tmdwlaw.com

s/ Elisabeth A. Holmes  
ELISABETH A. HOLMES  
OR Bar No. 120254 (*pro hac vice*)  
GEORGE A. KIMBRELL  
WA Bar No. 36050  
Center for Food Safety, 2nd Floor  
303 Sacramento Street  
San Francisco, CA 94111  
Tel. 415.826.2770  
Emails:  
eholmes@centerforfoodsafety.org  
gkimbrell@centerforfoodsafety.org

*Counsel for Plaintiff Center for Food Safety*

1 tmarshall@tmdwlaw.com

2 *Counsel for Plaintiffs*

3 s/Debra K. Kristensen

Debra K. Kristensen

4 Jeffrey C. Fereday

Preston N. Carter

5 Givens Pursley LLP

601 W. Bannock St.

6 Boise, ID 83702

dkk@givenspursley.com

7 jeffereday@givenspursley.com

prestoncarter@givenspursley.com

8 *Counsel for Defendant Cow Palace LLC*

9 s/Ralph H. Palumbo

10 Ralph H. Palumbo

Summit Law Group

11 315 Fifth Avenue S., Suite 1000

Seattle, WA 98104

12 ralphp@summitlaw.com

13 *Counsel for The Dolsen Companies and*  
14 *Three D Properties*

15

16

17

18

19

20

s/Brendan V. Monahan

Brendan V. Monahan

Sean A. Russel

Stokes Lawrence

120 N. Naches Avenue

Yakima, WA 98901

bvm@stokeslaw.com

sean.russel@stokeslaw.com

Mathew L. Harrington

Olivia Gonzalez

Stokes Lawrence

1420 Fifth Avenue

Seattle, WA 98101

MLH@stokeslaw.com

olivia.gonzalez@stokeslaw.com

*Counsel for Defendant Cow Palace LLC*

CERTIFICATE OF SERVICE

I hereby certify that on May 11, 2015 I filed a true and correct copy of the foregoing document with the Clerk of Court using the CM/ECF system, which will automatically generate service to the following:

- Beth E Terrell [bterrell@tmdwlaw.com](mailto:bterrell@tmdwlaw.com)
- Blythe H Chandler [bchandler@tmdwlaw.com](mailto:bchandler@tmdwlaw.com)
- Brad J Moore [brad@stritmatter.com](mailto:brad@stritmatter.com)
- Charles M Tebbutt [charlie@tebbuttlaw.com](mailto:charlie@tebbuttlaw.com)
- Daniel C Snyder [dan@tebbuttlaw.com](mailto:dan@tebbuttlaw.com)
- Elisabeth A Holmes [eholmes@centerforfoodsafety.org](mailto:eholmes@centerforfoodsafety.org)
- George Andreas Kimbrell [gkimbrell@centerforfoodsafety.org](mailto:gkimbrell@centerforfoodsafety.org),
- Jeffrey David Slothower [jslothower@lwhsd.com](mailto:jslothower@lwhsd.com)
- Jessica L Culpepper [jculpepper@publicjustice.net](mailto:jculpepper@publicjustice.net), [ystewart@publicjustice.net](mailto:ystewart@publicjustice.net)
- Paige Michelle Tomaselli [ptomaselli@centerforfoodsafety.org](mailto:ptomaselli@centerforfoodsafety.org)
- Svend A Brandt-Erichsen [svendbe@martenlaw.com](mailto:svendbe@martenlaw.com), [eherlihy@martenlaw.com](mailto:eherlihy@martenlaw.com)
- Toby James Marshall [tmarshall@tmdwlaw.com](mailto:tmarshall@tmdwlaw.com),

s/Brendan V. Monahan  
Brendan V. Monahan (WSBA # 22315)  
Attorney for Defendants  
Stokes Lawrence Velikanje Moore &  
Shore  
120 N. Naches Avenue  
Yakima, WA 98901-2757  
Telephone: (509) 853-3000  
Fax: (509) 895-0060  
[bvm@stokeslaw.com](mailto:bvm@stokeslaw.com)



*Consultants in the Earth and Environmental Sciences*

**LAGOON WORK PLAN**

**SDWA-10-2013-0080 / Yakima Valley Dairies**

**Cow Palace Dairy**

**Granger, Washington**

**April 20, 2015**

Prepared For:

Cow Palace LLC  
1631 N. Liberty Road  
Granger WA 98932

Title:

**Lagoon Work Plan  
SDWA-10-2013-0080 / Yakima Valley Dairies  
Cow Palace Dairy  
Granger, Washington**

Reference:

IES Project No. 1408-0012-005

Date:

April 20, 2015

Prepared By:

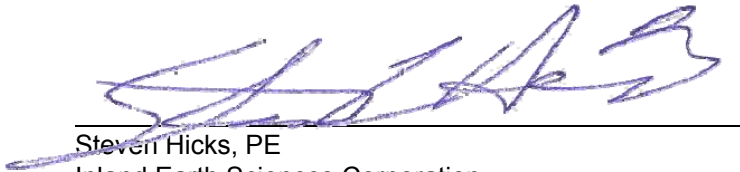

Steven Hicks, PE  
Inland Earth Sciences Corporation  
Design Engineer



Kevin Freeman  
Inland Earth Sciences Corporation  
Project Coordinator



**INLAND EARTH SCIENCES CORPORATION**  
8704 E. Dalton Avenue  
Spokane, Washington 99212  
(509) 563-6242





## TABLE OF CONTENTS

<b>DISTRIBUTION LIST</b> .....	<b>v</b>
<b>ACRONYMS AND ABBREVIATIONS</b> .....	<b>vi</b>
<b>1 INTRODUCTION</b> .....	<b>1</b>
<b>2 BACKGROUND</b> .....	<b>1</b>
<b>3 PROJECT ORGANIZATION</b> .....	<b>3</b>
<b>4 CONCEPTUAL LAGOON LINING DESIGN</b> .....	<b>4</b>
4.1 Flexible Membrane Liners.....	4
4.2 Side Slopes .....	5
4.3 Lagoon Bottom.....	6
4.4 Embankment.....	6
4.5 Lagoon Access.....	7
4.6 Gas Venting .....	7
4.7 Inlet and Outlet Piping.....	8
4.8 Operations, Maintenance, and Monitoring Plan.....	8
4.9 Washington Dam Safety Act.....	8
<b>5 PRE-DESIGN DATA COLLECTION</b> .....	<b>9</b>
5.1 Topographic Survey.....	9
5.2 Foundation Material Geotechnical Soil Sampling .....	10
5.3 Borrow/Import Material Sampling.....	10
<b>6 DESIGN PROCESS</b> .....	<b>11</b>
6.1 Pre-Final (90%) Design.....	11
6.2 Final (100%) Design .....	12
<b>7 IMPLEMENTATION STRATEGY</b> .....	<b>13</b>
<b>8 PROJECT SCHEDULE</b> .....	<b>13</b>
<b>9 REFERENCES</b> .....	<b>16</b>
<b>10 CERTIFICATION</b> .....	<b>17</b>

### TABLES

Table 1	Cow Palace Lagoon Dimensions
Table 2	WA NRCS Material Specification MS-222 – 40 mil HDPE Liner
Table 3	Embankment Minimum Top Widths
Table 4	2015 Project Schedule

### FIGURES

Figure 1	Lagoon Locations
Figure 2	Typical Lagoon Liner Cross-Section



## TABLE OF CONTENTS

---

### APPENDICES

Appendix A	ASTM Standard D420 Site Characterization for Engineering Design and Construction Purposes
Appendix B	ASTM Standard D422 Particle-Size Analysis of Soils
Appendix C	ASTM Standard D698 Laboratory Compaction Characteristics of Soil Using Standard Effort (12 400 ft-lbf/ft <sup>3</sup> (600 kN-m/m <sup>3</sup> ))
Appendix D	ASTM Standard D1140 Amount of Material in Soils Finer than No. 200 (75- $\mu$ m) Sieve
Appendix E	ASTM Standard D2487 Classification of Soils for Engineering Purposes (Unified Soil Classification System)
Appendix F	ASTM Standard D4318 Liquid Limit, Plastic Limit, and Plasticity Index of Soils
Appendix G	WA NRCS Conservation Practice Standard No. 313, Waste Storage Facility
Appendix H	WA NRCS Conservation Practice Standard No. 360, Waste Facility Closure
Appendix I	WA NRCS Conservation Practice Standard No. 521A, Pond Sealing or Lining - Flexible Membrane
Appendix J	WA NRCS Material Specification MS-222, HDPE and LLDPE Flexible Membrane Liner
Appendix K	WA NRCS Material Specification MS-223, Geosynthetic Clay Liner



**DISTRIBUTION LIST**

<b>NAME</b>	<b>ORGANIZATION</b>
Adam Dolsen	Cow Palace
Eric Winiecki	EPA
Rene Fuentes	EPA
Jennifer MacDonald	EPA
Kevin Freeman	Inland Earth Sciences
Steve Hicks	Inland Earth Sciences
Brendan Monahan	Stokes Lawrence Velikanje Moore & Shore



## ACRONYMS AND ABBREVIATIONS

---

ac-ft	acre-feet
AOC	Administrative Order on Consent
AASHTO	American Association of State Highway and Transportation Officials
AMRL	AASHTO Materials Reference Laboratory
ASTM	American Society of Testing and Materials
cm/s	centimeters per second
EPA	U.S. Environmental Protection Agency
FML	Flexible Membrane Liner
ft	foot or feet
GCL	Geosynthetic Clay Liner
HSP	Health and Safety Plan
HDPE	High-Density Polyethylene
lb	pounds (U.S.)
lb/in	pounds per inch
lb/in <sup>2</sup>	pounds per square inch
in	inch
IES	Inland Earth Sciences Corporation
µm	micrometers
NRCS	Natural Resources Conservation Service
NAVD	North American Vertical Datum
OM&M	Operations, Monitoring, and Maintenance
PC	Project Coordinator
oz	ounce (U.S.)
oz/sq yd	ounce per square yard
WA	Washington State
YVD	Yakima Valley Dairies



## 1 INTRODUCTION

This Lagoon Work Plan was prepared by Inland Earth Sciences Corporation (IES) on behalf of Cow Palace, LLC. (Cow Palace). This Lagoon Work Plan is a work plan for the design and installation of liner systems in lagoons located at the Cow Palace Dairy consistent with the requirements identified in Section III.F.6 of the Statement of Work (SOW) [Appendix A of the Administrative Order on Consent (AOC) SDWA 10-2013-0080].

Specifically, Section III.F.6 of the AOC SOW identifies that “the Lagoon Work Plan shall describe, at the Respondents election, measures to address leakage or how Respondents will line those lagoons to meet the current standard at the rate of one lagoon per Dairy Facility per year.” The “current standard” is identified as the soil permeability rate of  $1 \times 10^{-6}$  centimeters per second (cm/s) identified in the Washington National Resources Conservation Service (WA NRCS) Conservation Practice Standard No. 313 – Waste Storage Facility (WA NRCS, 2004). Further, lining is identified as lining as described in NRCS Conservation Practice Standard No. 521 A through D (NRCS, 2011).

## 2 BACKGROUND

Pursuant to the requirements of Section III.F.6 of the AOC SOW, the Cow Palace Dairy submitted to the U.S. Environmental Protection Agency (EPA) a Cow Palace, LLC Lagoon Review Report – Version 2 (ARCADIS, 2013) on August 8, 2013. As required by Section III.F.6 of the AOC SOW, the purpose of the Lagoon Review Report was to “provide(s) information, i.e., plans and specifications signed by a State of Washington licensed professional engineer, that shows that existing lagoons are constructed to current WA NRCS 313 standards, including a soil permeability rate not to exceed  $1 \times 10^{-6}$  (“NRCS 313 standard”).” The results of the Cow Palace, LLC Lagoon Review Report – Version 2 showed that Lagoon #4 was the only lagoon at the Cow Palace Dairy that was constructed after the promulgation of the current 2004 Washington (WA) NRCS Conservation Practice Standard No. 313 – Waste Storage Facility. Lagoon #4 was constructed in 2006. Sufficient design and construction quality assurance/quality control documentation was available to show that Lagoon #4 was constructed to have a soil foundation material permeability of  $5.7 \times 10^{-7}$  centimeters per second (cm/s). Because the remainder of lagoons at the Cow Palace Dairy were constructed prior to the promulgation of the 2004 WA NRCS Conservation Practice Standard No. 313 foundation material permeability requirement, no documentation was found or expected to be found that showed the lagoons complied with the 2004 WA NRCS Conservation Practice Standard No. 313 foundation material permeability requirement.

Figure 1 shows the locations of liquid manure storage lagoons and other water storage facilities at the Cow Palace Dairy that either contain liquid manure or water that may have come into contact with manure at the dairy. In total, there are four lagoons (numbered 1 through 4), two settling basins (A and B), two catch basins (Northeast [NE] and Northwest [NW]), and a Safety Debris Basin. The approximate dimensions of each facility are shown on Table 1.

**Table 1 – Cow Palace Lagoon Dimensions**

Lagoon	Length (ft)	Width (ft)	Depth (ft)	Capacity (gallons)	Capacity (ac-ft)	Interior Side Slopes
Lagoon #1	430	280	30	18,300,000	56	2H:1V
Lagoon #2	200	300	15	5,200,000	16	2H:1V
Lagoon #3	200	225	20	4,400,000	13.6	2H:1V
Lagoon #4	265	200	15	3,700,000	11.3	3H:1V
Settling Basin A	200	133	10	1,500,000	4.7	1H:1V
Settling Basin B	200	133	10	1,500,000	4.7	1H:1V
Catch Basin NE	130	175	7	1,100,000	3.4	2H:1V
Catch Basin NW	135	243	25	3,100,000	9.4	2H:1V
Safety Debris Basin	170	200	8	2,000,000	6.2	2H:1V

Section III.F.6 of the AOC SOW requires the development of a Lagoon Evaluation Plan “to determine whether each such lagoon meets the current NRCS 313 standard. This evaluation shall include leak detection or water balance tests to determine that each lagoon is not leaking beyond the current NRCS 313 standard.” The Cow Palace Dairy has submitted to EPA several iterations of the Lagoon Evaluation Plan that included different evaluation methods (water balance testing and physical testing of in situ soil foundation material) for the purpose of determining the leakage rates and/or soil permeability rates of the lagoon soil foundation materials without coming to agreement with EPA on an evaluation method amenable to both parties.

In order to move forward with implementation of the AOC in a timely manner, the Cow Palace Dairy has elected to forgo pursuit of the development and implementation of a Lagoon Evaluation Plan to determine which, if any, lagoons may require measures to address leakage or lining. Rather, the Cow Palace Dairy has elected to install liner systems in all of its lagoons that contain liquid manure or water that may have come into contact with manure at the dairy regardless of their status with respect to the 2004 WA NRCS Conservation Practice Standard No. 313 permeability standard (soil foundation material permeability of  $1 \times 10^{-6}$  cm/s).

The Cow Palace Dairy will install liner systems in the following lagoons consistent with the requirements of WA NRCS Conservation Practice Standard 521A – Pond Sealing or Lining – Flexible Membrane (WA NRCS, 2011) in order to demonstrate compliance with WA NRCS Conservation Practice Standard No. 313 permeability requirements:

- Catch Basin NW
- Settling Basin A
- Settling Basin B
- Lagoon #1
- Lagoon #2
- Lagoon #3
- Lagoon #4
- Safety Debris Basin

As noted above, Lagoon #4 was constructed in 2006, following promulgation of the 2004 WA NRCS Conservation Practice Standard No. 313 permeability requirement. Construction quality



assurance documentation was available to demonstrate that the permeability of the Lagoon #4 foundation material ( $5.7 \times 10^{-7}$  cm/s) was less than the permeability requirement ( $1 \times 10^{-6}$  cm/s). While the Cow Palace Dairy has demonstrated that Lagoon #4 is in compliance with the requirements of Section III.F.6 of the AOC SOW, the Cow Palace Dairy has elected to conduct additional work at Lagoon #4 to maintain consistency in operations and maintenance with the other manure storage lagoons in its manure management system.

Catch Basin NE is not currently included in this Lagoon Work Plan for the installation of a liner system because it is currently slated for elimination. Instead of lining Catch Basin NE, a lagoon abandonment design will be developed for Catch Basin NE that is consistent with the requirements of NRCS Conservation Practice Standard No. 360 – Waste Facility Closure (WA NRCS, 2013). In the event that operational circumstances do not allow for the abandonment of Catch Basin NE, a lagoon liner system design package consistent with this Lagoon Work Plan will be developed and implemented for Catch Basin NE.

### **3 PROJECT ORGANIZATION**

This section presents the organization structure and lines of communication that will be followed to implement the activities presented in this Lagoon Work Plan.

The Cow Palace Dairy has retained IES to develop and implement this Lagoon Work Plan for the purposes of designing lagoon liner systems for each of the lagoons identified in Section 2.0 and implementation of the lagoon liner system designs.

The Yakima Valley Dairies (YVD) Project Coordinator (PC) is responsible for the implementation of all activities identified in this Lagoon Work Plan, and will maintain communication with the EPA PC as required to communicate progress and resolve issues that may arise during the design and implementation process. The YVD PC has overall authority over the project team and implementation of the Lagoon Work Plan.

The Design Engineer is responsible for the implementation of pre-design data collection activities (Section 5); review and use of data for the purpose of lagoon liner design; and development and review of lagoon liner system design basis reports, design drawings, specifications, and cost estimates that will be generated during the implementation of the Lagoon Work Plan. The Design Engineer is a Washington State licensed Professional Engineer and will sign and seal the final design drawings developed for each lagoon.

The YVD PC and the Design Engineer will develop appropriate corrective actions to address any potential issues or deficiencies that may occur related to pre-design data collection activities and laboratory analysis. Corrective actions, if required, will be communicated to the EPA PC and will be implemented and documented, as required.

Laboratory analysis of soil samples will be performed by soils laboratories certified to perform the testing using the methods identified in Section 5 by the American Association of State Highway and Transportation Officials (AASHTO) Materials Reference Laboratory (AMRL). Because of the large number of samples that will be collected during the pre-design data collection phase at the Cow Palace Dairy and other facilities subject to the requirements of the AOC SOW, the compressed design schedule required to accommodate implementation of lagoon lining in a





timely manner, and the limited number of laboratories and laboratory capacity, it will be necessary to employ multiple laboratories to perform analysis of the samples. At a minimum, all samples collected from a single lagoon will be sent to the same laboratory. This will maintain consistency in sample results and eliminate variability that may occur between laboratories conducting the same analysis.

## **4 CONCEPTUAL LAGOON LINING DESIGN**

This section presents an overview of the major components of the typical conceptual design that will be employed for liner systems for the lagoons and water storage features at the Cow Palace Dairy identified in Section 2.0. The major components of the typical conceptual design were selected and developed to comply with design criteria and additional considerations identified in the 2004 WA NRCS Conservation Practice Standard No. 313. The major components discussed in this section are not intended to present an exhaustive or all-inclusive listing of all components that will be incorporated into each lagoon liner system design. However, the major components of the typical conceptual design discussed in this section are sufficient to provide a clear picture and understanding of the technologies that will be employed to line lagoons and water storage features at the Cow Palace Dairy. As noted in the subsections below, some components will be common to all lagoons and water features (such as, geosynthetic clay liners and synthetic flexible membrane liners) while others may only be employed at select locations (such as, concrete access ramps).

### **4.1 Flexible Membrane Liners**

All lagoons and water storage features identified for lining will be lined with a liner system consisting of a geosynthetic clay liner (GCL) and a 40 mil high density polyethylene (HDPE) liner system. A typical cross-section showing the lagoon liner system is shown on Figure 2. The GCL will be placed over a compacted soil foundation consistent with the requirements of WA NRCS Conservation Practice Standard No. 521A – Pond Sealing or Lining – Flexible Membrane (WA NRCS, 2011). The GCL will meet the minimum requirements identified in WA NRCS Material Specification MS-223: “Geosynthetic Clay Liner” (WA NRCS, 2002).

A cushion layer may be placed between the GCL and the underlying compacted soil foundation if the underlying soil foundation material (interior side slopes and bottoms) contains sharp rocks or rocks greater than three-eighths (3/8) of an inch (in) in diameter in the upper 6 inches of the soil foundation material. The cushion layer will consist of a 10-ounce per square yard (oz/sq yd) or heavier non-woven geotextile placed between the soil foundation material and the GCL. In the event that it is determined that the use of a geotextile cushion layer is not optimal, then the upper 6 inches of the soil foundation material may be removed, screened to remove rocks greater than 3/8-in diameter, replaced, and recompacted prior to placement of the GCL.

The 40 mil HDPE liner will be placed directly above the GCL. The 40 mil HDPE liner material will meet the requirements presented in WA NRCS Material Specification MS-222: “HDPE and LLDPE Flexible Membrane Liner” (WA NRCS, 2002) shown in Table 2. Table 2 presents material specifications for both smooth and textured 40 mil HDPE liner material. The selection of smooth versus textured HDPE liner will be determined during design based on the expected operational conditions and maintenance requirements for each lagoon or water storage feature.

**Table 2 – WA NRCS Material Specification MS- 222 – 40 mil HDPE Liner**

Property	Test Method	Smooth	Textured
Density, g/cc	ASTM D 1505	0.940	0.940
Tensile Properties:	ASTM D 638		
• Yield Stress, lb/in		84	84
• Break Stress, lb/in		152	60
• Yield Elongation, %		12	12
• Break Elongation, %		560	100
Tear Resistance, lb	ASTM D 1004	28	28
Puncture Resistance, lb	ASTM D 4833	72	60
Carbon Black Content, %	ASTM D 1603	2-3	2-3
Carbon Black Dispersion	ASTM D 5596	Cat 1-2	Cat 1-2
Seam Properties:	ASTM D 4437		
• Shear Strength, lb/in		80	80
• Peel Strength, lb/in <sup>2</sup>		52/FTB	52/FTB

If during design, it is determined that a cushion layer is required to provide protection for the GCL and 40 mil HDPE liner during installation, a cushion layer may be placed over the GCL prior to the installation of the 40 mil HDPE liner. The cushion layer will consist of a 3 oz/sq yd or heavier non-woven geotextile.

The combined GCL and 40 mil HDPE liner system will be secured in a continuous anchor trench located on top of the lagoon embankment a minimum of 1 foot above the maximum operating level. The dimensions of the anchor trench will be determined during design.

A minimum of 12 inches of compacted fill will be placed over the liner system. The fill material will be screened to remove all sharp rocks and rocks greater than 3/8 of an inch in diameter. The fill material will be compacted to a level equal to or greater than 90 percent of the Standard Proctor (ASTM D 698) density for those soils to reduce the potential for settlement, ensure slope stability, and reduce soil permeability. The thickness of the cover fill material will be increased in higher traffic areas and areas where additional protection of the liner system is desired. A non-woven geotextile will be placed 3 inches below the surface of the final top elevation of the fill to act as a warning layer to protect the liner system.

During design, it may be determined that operations and maintenance of the liner system may be simplified by exposing the 40 mil HDPE liner. In this event, a minimum of 12 inches of compacted fill will be placed directly over the GCL liner and the 40 mil HDPE liner will be placed on top of the compacted fill.

## 4.2 Side Slopes

The interior and exterior (where present) side slopes of all lagoons will be evaluated for compliance with design criteria in the current 2004 WA NRCS Conservation Practice Standard No. 313. The current design criteria identify that the combined side slopes (interior plus exterior) shall not be less than 5 horizontal to 1 vertical (5H:1V), with no single slope greater than 2H:1V. In the event that an exterior side slope is not present, for example, a lagoon completed below or at grade, then the no single slope greater than 2H:1V guides the maximum slope allowable.



For all lagoon liner systems designed under this Lagoon Work Plan, the interior side slopes will be reshaped and graded to a 3H:1V or flatter slope prior to the installation of the liner system. All exterior side slopes, if present, will be graded to a 2H:1V or flatter slope as determined during design.

All side slope material will be compacted to a level equal to or greater than 90 percent of the Standard Proctor (ASTM D 698) density for those soils to reduce the potential for settlement, ensure slope stability, and reduce soil permeability.

In the event that import material or local borrow material is required to meet material balances required for the reshaping and regrading of interior and exterior slopes, the material requirements, testing, and placement specifications will be included in the lagoon lining design.

#### 4.3 Lagoon Bottom

Lagoon bottoms will be regraded and sloped to encourage drainage to one point in the lagoon bottom. This low spot will be the location where solids cleanout will occur. Depending on operational and maintenance requirements, the low spot may be configured as a swale or sump to facilitate cleanout.

All lagoon bottom foundation material will be compacted to a level equal to or greater than 90 percent of the Standard Proctor (ASTM D 698) density for those soils to reduce the potential for settlement and reduce soil permeability.

#### 4.4 Embankment

Embankment top widths will meet the criteria contained in WA NRCS Conservation Practice Standard No. 313 (Table 3).

**Table 3 – Embankment Minimum Top Widths**

Total Embankment Height (ft)	Top Width (ft)
15 or less	8
15 – 20	10
20 – 25	12
25 – 30	14
30 – 35	15

At a minimum, all embankments will extend 2 feet above the lagoon's maximum operating level. The first foot above the operating level will contain the liner system and anchor trench and the second foot will include the liner soil protective cover and lagoon access roadway at the top of the embankment. In cases where no embankment is present (such as lagoons constructed below grade) then the maximum operating level will be one foot below grade, and the liner system will extend up to grade. The soil protective cover and lagoon access roadway will be constructed above grade.



#### **4.5 Lagoon Access**

Access to the bottoms of manure storage lagoons and other water storage features that experience significant solids build up is required in order to remove solids physically with heavy equipment or introduce agitation to the solids that results in their liquefaction allowing their removal by pumping. The Cow Palace Dairy is in the process of installing a centrifuge at the facility. The centrifuge will be placed in the manure process stream after the current solid separator screens. Liquid from the separator screens will be directed through the centrifuge. It is anticipated that the use of the centrifuge will greatly reduce the volume of solids entering the liquid manure storage system.

As part of the introduction of the centrifuge into the solid separation process at the Cow Palace Dairy, some modifications to the liquid manure handling system will also occur. Settling Basin A will be used solely to handle liquid manure collected using vacuum trucks. This material is typically sold directly to third party farmers for use as a fertilizer and is therefore not screened or added to the rest of the liquid manure storage system. Liquid from the centrifuge will be directed to Settling Basin B, then to Lagoon #1, Lagoon #2, Lagoon #3, and finally Lagoon #4 before application as a fertilizer to the Cow Palace Dairy cropping fields.

The use of the centrifuge is expected to greatly reduce the volume of solids remaining in the liquid manure and therefore reduce the amount of solids that will settle out of the liquid manure as it moves through the liquid manure storage system. Therefore, access for cleanout using agitation equipment would only likely be needed at Settling Basin A, Settling Basin B, and Lagoon #1.

For Settling Basin A, Settling Basin B, and Lagoon #1, concrete access ramps and equipment pads will be included in the lagoon liner design package. The concrete ramps and equipment pads will be constructed above the liner system. This will allow the liner system to be continuous across the lagoon. The access ramps will be placed on slopes of 5H:1V or flatter and will extend to the bottom elevation of the lagoon. At the end of the access ramp, an equipment pad will be placed that is, at a minimum, equal in width to the access ramp and of sufficient length to accommodate solids cleanout equipment safely.

#### **4.6 Gas Venting**

The presence of organic materials, even at trace levels, can allow for the production of gasses. The presence of these gasses can result in whaling, bubbling, uplift, or the eventual failure of flexible membrane liners. This is a common occurrence when manure lagoons have been retrofitted with flexible membrane liners.

Prior to the initiation of design activities, all liquid and solid manure will be removed from lagoons down to the current soil foundation material at the direction of the Design Engineer. While every effort will be made to ensure that all organics have been removed, the potential exists that some organic material or residuals may remain behind. Therefore, gas venting will be included in all lagoon liner system designs developed under this work plan.

The gas venting system will include vents penetrating the liner system. The vents will be located in the upper portion of the 1 foot of freeboard between the maximum operating level and the top of the embankment or ground surface. The vent penetrations in the HDPE material will be



covered by a layer of HDPE that is sealed to the 40 mil HDPE liner on three sides allowing gasses to escape on the fourth side. The dimensions of the gas vent penetrations and their spacing along the perimeter of the liner will be determined during design.

In addition to the vents, a piping system may also be included to aid in venting gasses from beneath the liner. The need for the piping system will be determined during design, but would likely include perforated pipe placed in sand-filled ditches located in the lagoon bottom and side slopes. The spacing and configuration of the piping vent system would be determined during design.

#### **4.7 Inlet and Outlet Piping**

All inlet and outlet piping associated with lagoons being lined will be replaced with HDPE piping. The use of HDPE piping will allow for more secure and consistent connections with the GCL and HDPE liner materials versus other materials. The extent of piping replacement upstream or downstream of the lagoon liner will be determined during design and construction.

#### **4.8 Operations, Maintenance, and Monitoring Plan**

All lagoon liner designs will include and operations, maintenance, and monitoring plan (OM&M Plan). Appropriate operations, maintenance, and monitoring are necessary to ensure the safe and efficient operation of lagoon liner systems. The OM&M Plan will include, at a minimum:

- Identification of the maximum operating liquid level
- Lagoon liquid level and water balance monitoring
- Lagoon operation details
- Piping and pump maintenance
- Lagoon cleanout methodology
- Lagoon liner inspection and testing schedule

#### **4.9 Washington Dam Safety Act**

For all waste storage ponds that impound 10 acre-feet or more of wastewater, Washington Administrative Code (WAC) Chapter 173-175 Dam Safety Regulation, requires review and approval of the construction plans and specifications by the Washington Dam Safety Office (Department of Ecology).

Review of Table 1 shows that four lagoons at the Cow Palace Dairy currently exceed the 10 acre-foot volume threshold. However, the volume used to determine if a structure exceeds 10 acre-feet of storage is the volume of wastewater stored behind a dam from the elevation measured from the lowest point of the outside limit of the impoundment barrier to the maximum attainable water surface elevation of the reservoir pool that could occur during extreme operating conditions. Taking this into consideration, only Lagoon #1 would be expected to trigger Dam Safety Act requirements.

Following the topographic survey and design of lagoon side slopes and bottoms, each lagoon will be evaluated with respect to Dam Safety Act storage threshold requirements. If lagoons are found to have stored volumes that exceed Dam Safety Act criteria, either changes to the design of the lagoon will be made to reduce the volume below the criteria or design and schedule modifications



will be made to accommodate Washington Department of Ecology Dam Safety Act review. Any changes to design or schedule resulting from the need to accommodate Washington Department of Ecology Dam Safety Act review will be conveyed by the YVD PC to the EPA PC.

Lagoon #1 is currently included in the Washington Department of Ecology inventory of regulated dams and modifications were previously made to comply with Dam Safety Act Criteria, specifically the inclusion of a concrete emergency spillway. As noted in the project schedule (Section 8), Lagoon #1 is slated for design and construction in 2016. The Design Engineer will contact the Washington Department of Ecology regarding the potential need for additional review of the Lagoon #1 liner design package as a result of changes to the lagoon resulting from installation of a liner. If modifications to the schedule resulting from inclusion of Washington Department of Ecology Dam Safety Act review are required, they will be conveyed by the YVD PC to the EPA PC.

## **5 PRE-DESIGN DATA COLLECTION**

This section identifies the anticipated pre-design data collection activities required to provide information necessary to support lagoon liner design activities. All anticipated pre-design data collection activities are commonly conducted data collection activities identified in American Society for Testing and Materials (ASTM) standards and are implemented by or under the direction of a professional engineer. While every effort has been made to identify all pre-design data collection activities that will occur to support the lagoon liner design process, unforeseen circumstances or design requirements may require collection of additional data that were not anticipated during the development of this Lagoon Work Plan. In the event that this occurs, the YVD PC will convey these additional data collection activities to the EPA PC for discussion prior to the initiation of data collection activities.

Lagoon liquid removal and solid material cleanout will be necessary prior to the commencement of pre-design data collection activities. Lagoon liquid removal and solid material cleanout will be conducted by Cow Palace Dairy personnel or a contractor hired by the Cow Palace Dairy. All free liquid will be removed from the lagoon and solids will be removed down to the current lagoon soil foundation material. The extent of material removal will be checked by the Design Engineer to ensure that solids removal are sufficient to provide a sufficient beginning surface for design purposes. Under no circumstances will collection of pre-design data occur until the liquids and solids have been removed from the lagoon to the satisfaction of the Design Engineer.

### **5.1 Topographic Survey**

Following lagoon drawdown and cleanout, a topographic survey of the lagoon will be conducted by a Washington State licensed surveyor. Lagoon dimensions and elevations will be recorded as well as the presence and location of all inlet and outlet structures associated with the lagoon. The lagoon topographic survey will extend a minimum of 50 feet beyond the edge of the lagoon embankment or the toe of the lagoon embankment, if present.

All lagoon-specific survey information will be recorded in a local coordinate system for the facility. Horizontal measurements will be accurate within 1.0-foot and vertical measurement will be accurate within 0.01-feet. The local coordinate system will be converted to the Washington State Plane Coordinate System for horizontal measurements and the North American Vertical Datum of





1988 (NAVD88) for mapping and other purposes by surveying in the base control points used to conduct the survey at the facility.

## 5.2 Foundation Material Geotechnical Soil Sampling

Samples of foundation material will be collected from each lagoon. The foundation material soil samples will be sent to a soils laboratory for testing using the following methods:

- ASTM D2487 – Classification of Soils for Engineering Purposes – using:
  - ASTM D422 – Test Method for Particle Size Analysis of Soils
  - ASTM D1140 – Test Method for Amount of Material in Soils Finer than No. 200 (75  $\mu\text{m}$ ) Sieve
  - ASTM D4318 – Test Method for Liquid Limit, Plastic Limit, and Plasticity Index of Soils
- ASTM D 698 – Test Methods for Moisture-Density Relations of Soils and Soil-Aggregate Mixtures Using 5.5-lb Rammer and 12-in Drop (Standard Proctor)

Sample collection activities will be conducted by or under the direction of the Design Engineer and will follow the sampling guidelines and requirements presented in ASTM D 420, “Standard Guide to Site Characterization for Engineering, Design, and Construction Purposes,” specifically Section 8 “Sampling”.

Based on historic site observations, the material types within each lagoon are generally consistent within a single lagoon. Therefore, collection of representative samples is not expected to be complicated by heterogeneities within a lagoon. However, the Design Engineer will inspect the foundation material within each lagoon to verify this assumption or identify areas where heterogeneities may be present. For lagoons with relatively heterogeneous foundation materials, three samples will be collected; one from the bottom of the lagoon and two from opposite interior side slopes. If heterogeneities or significant differences in material types are determined to be present within a lagoon, additional samples will be collected from these areas in addition to the three planned samples. All samples will be sent to the laboratory and homogenized prior to testing.

## 5.3 Borrow/Import Material Sampling

In the event that additional material is required in order to perform side slope and lagoon bottom reshaping required as part of the lagoon liner design, soil samples will be collected from potential borrow areas or import material sources to verify their ability to meet design requirements and specifications using the same laboratory analysis methods described for foundation material sampling in Section 5.2. The need for and collection of borrow or import material samples will be determined and implemented by or under the direction of the Design Engineer.





## 6 DESIGN PROCESS

This section presents a description of the design process that will be employed for the design of lagoon liner systems for the Cow Palace Dairy lagoons. The design process selected for the design of the lagoon liner systems was selected based on the relatively straight-forward design requirements associated with design of lagoon liner systems for existing lagoons as well as the significant time constraints associated with operational considerations and a desire to implement a portion of the designs in 2015.

Rather than the traditional design process of Preliminary (30%), Intermediate (60%), Pre-Final (90%), and Final (100%) design packages. The first design package that will be submitted to EPA will be at the Pre-Final (90%) design level. This will provide EPA with a relatively complete and straight-forward design package for review. In order to facilitate EPA design review, a design team review meeting between EPA and the design team will occur approximately two weeks after the submittal of the Pre-Final (90%) design packages to EPA. The purpose of this meeting is to allow EPA and the design team to go over the design together and answer questions and provide clarification regarding components of the design. The intent of the design team meeting is to facilitate the review process and allow the design team to be prepared to fully address any design comments in an appropriate and efficient manner.

It is assumed that by having a design team meeting that any comments on the Pre-Final design will be easily addressed allowing the Final design to be submitted and approved without additional review and allow bidding, procurement, and construction activities to proceed in time for lagoon liner installation to occur during the 2015 construction season.

### 6.1 Pre-Final (90%) Design

The Pre-Final (90%) design package will include:

- A Draft Basis of Design Report
- Pre-Final construction drawings – currently anticipated to include:
  - Title Sheet
  - Legend and General Notes
  - Existing Conditions
  - Final Grades & Erosion Control
  - Liner Layout
  - Cross-Sections
  - Details
- Pre-Final Specifications in Construction Specifications Institute's Master Format. This document is currently anticipated to include:
  - DIVISION 1 – GENERAL REQUIREMENTS
    - 01 35 13 – Special Project Procedures
    - 01 57 13 – Temporary Erosion and Sediment Control



- DIVISION 2 – EXISTING CONDITIONS
  - 02 41 00 – Demolition
- DIVISION 3 – CONCRETE (for lagoons with access ramps)
- DIVISION 31 – EARTHWORK
  - 31 10 00 – Site Preparation and Surveying
  - 31 23 13 – Subgrade Preparation
  - 31 23 16 – Excavation
  - 31 23 23 – Fill and Backfill
  - 31 23 23.15 – Trench Backfill
  - 31 32 00 – Soil Stabilization
  - Supplement: Contractor's Certification of Subsurface Acceptability
  - 31 32 19.16 – Geotextile
- DIVISION 32 – EXTERIOR IMPROVEMENTS
  - 32 11 23 – Aggregate Base Courses
- DIVISION 33 – UTILITIES
  - 33 40 00 – Storm Drainage Utilities
  - 33 47 13.01 – High Density Polyethylene (HDPE) Liner
  - Supplement: Geomembrane Installer's Certification of Subsurface Acceptability
- Draft Final Operations, Monitoring, and Maintenance (OM&M) Plan
- Draft Final Cost Estimate
- Updated Construction Schedule

## **6.2 Final (100%) Design**

Following EPA review and approval of the Pre-Final (90%) design package, a Final (100%) design package will be developed and issued that is sufficient for procurement and construction of the lagoon liner.

The Final (100%) design package will include:

- A Final Basis of Design Report
- Final construction drawings signed and sealed by a Washington Professional Engineer
- Final construction specifications
- Final OM&M Plan
- Final cost estimate
- Final construction schedule



## 7 IMPLEMENTATION STRATEGY

This section provides an overview of the implementation strategy that will be employed by the Cow Palace Dairy to install lagoon liner systems in lagoons at the facility. Given the compressed schedule required in order to line lagoons and still maintain operations at the dairy, a modified design/bid/build process will be employed for lagoon lining at the Cow Palace Dairy.

The lagoon liner design will be prescriptive enough to allow bidding from multiple contractors for well-defined portions of the work. Currently it is anticipated that one contractor will be engaged for earth work activities (regrade and reslope of interior lagoon slopes and bottoms) and another contractor for liner system installation. In addition, portions of the earthwork may be self-performed by Cow Palace if personnel and equipment are available. IES will serve as the owner's engineering representative during the bidding process and provide oversight and quality assurance and control during the construction process.

The preliminary construction sequence is currently anticipated to include the following, with the responsible party indicated in parentheses:

1. Lagoon pumping and solids removal to soil subgrade (Cow Palace)
2. Topographic survey (Subcontractor - TBD)
3. Pre-design data collection (Design Engineer)
4. Regrade, reslope, and compact interior slopes, bottom, and exterior slopes (Earthwork Contractor)
5. Trenching & Piping (Earthwork Contractor)
6. Geotextile Placement (Liner Contractor)
7. Liner Placement (Liner Contractor)
8. Backfilling (Earthwork Contractor)
9. Embankment Treatment – liner protection and access (Earthwork Contractor)
10. Concrete Ramps (Earthwork Contractor or separate Concrete Contractor)

The preliminary construction sequence will be modified and roles and responsibilities will be refined during the design, bidding, and award process.

## 8 PROJECT SCHEDULE

This section presents the preliminary project schedule for the implementation of lagoon lining activities at the Cow Palace Dairy. Table 4 presents the anticipated 2015 schedule. Subsequent years will observe a similar schedule. However, a revised schedule will be submitted by the YVD PC to the EPA PC at the beginning of each year.

**Table 4 – 2015 Project Schedule**

<b>Task</b>	<b>Start Date</b>	<b>Completion Date</b>
2015 Lagoons (Settling Basin A, Settling Basin B, Catch Basin NW) – Topographic Survey and Pre-Design Data Collection	Upon EPA Approval of Lagoon Work Plan (Estimated April 15, 2015)	Approximately 2 weeks (Estimated May 1, 2015)
Pre-Final (90%) Design for 2015 Lagoons (Settling Basin A, Settling Basin B, Catch Basin NW)	Upon completion of Topographic Survey and Pre-Design Data Collection (Estimated May 1, 2015)	Approximately 1 month after completion of Topographic Survey and Pre-Design Data Collection (Estimated June 1, 2014)
EPA Review of Pre-Final (90%) Design for 2015 Lagoons (Settling Basin A, Settling Basin B, Catch Basin NW)	Upon submittal of Pre-Final (90%) Design (Estimated June 1, 2015)	30 days following submission of Pre-Final (90%) Design (Estimated July 1, 2015)
Pre-Final (90%) Design Meeting	2 weeks after submittal of Pre-Final Design for 2015 Lagoons (Estimated June 15, 2015)	2 weeks after submittal of Pre-Final Design for 2015 Lagoons (Estimated June 15, 2015)
Final (100%) Design for 2015 Lagoons (Settling Basin A, Settling Basin B, Catch Basin NW)	Upon receipt of EPA Review and Approval of Pre-Final (90%) Design (Estimated July 1, 2015)	15 days after receipt of EPA comments on Pre-Final (90%) Design (Estimated July 15, 2015)
Bidding and Procurement	Upon issue of Final (100%) Design (Estimated July 15, 2015)	30 days after issue of Final (100%) Design (Estimated August 1, 2015)
Construction of 2015 Lagoons	2 weeks after completion of bid and procurement (Estimated August 15, 2015)	75 days after start of construction (Estimated October 31, 2015)

The above schedule was developed to allow the Cow Palace Dairy to implement liner construction in Settling Basin A, Settling Basin B, and Catch Basin NW in 2015. The time lines for design development and agency review are extremely tight and will require significant efforts on behalf of the Cow Palace Dairy, design team, and EPA to ensure the successful implementation of lagoon lining activities. In the event that any time slippage occurs as a result of scheduling difficulties, it is likely that implementation of the designs will not be able to occur until the 2016 construction season and would likely delay any subsequent year's groupings of lagoons for one year.



Currently, the Cow Palace Dairy has identified the following lagoon groupings for implementation each year:

- 2015:
  - Settling Basin A
  - Settling Basin B
  - Catch Basin NW
- 2016
  - Lagoon #1
  - Lagoon #4
- 2017
  - Lagoon #2
  - Lagoon #3
- 2018
  - Safety Debris Basin
  - Abandon Catch Basin NE

For lagoons in years 2016 through 2018, the review schedule will still remain similar to the 2015 schedule shown in Table 4. However, while it may be possible to perform lagoon cleanout and pre-design data collection activities earlier depending on weather and irrigation schedules it is likely to only gain a number of weeks versus months for the schedule.



## **9 REFERENCES**

ARCADIS. 2013. Administrative Order on Consent (SDWA-10-2013-0080) – Cow Palace, LLC Lagoon Review Report – Version 2. August 8, 2013.

Washington Natural Resource Conservation Service (WA NRCS), 2004. Conservation Practice Standard No. 313 – Waste Storage Facility. December 2004.

WA NRCS, 2013. Conservation Practice Standard No. 360 – Waste Facility Closure. January 2013.

WA NRCS, 2011. Conservation Practice Standard No. 521 A – Pond Sealing or Lining – Flexible Membrane. September 2011.

WA NRCS, 2002. Material Specification 222: HDPE and LLDPE Flexible Membrane Liner. July 2002.

WA NRCS, 2002. Material Specification 223: Geosynthetic Clay Liner. July 2002.



## 10 CERTIFICATION

I certify under the penalty of law that this document and all attachments were prepared by me or under my direction or supervision in accordance with a system designed to assure that qualified personnel gathered and evaluated the information submitted. Based on my inquiry of any and all persons directly responsible for gathering and analyzing the information obtained, I certify that the information contained in or accompanying this submittal is to the best of my knowledge and belief, true, accurate and complete. As to those identified portion(s) of this submittal for which I cannot personally verify the accuracy, I certify that this submittal and all attachments were prepared in accordance with procedures designed to assure that qualified personnel properly gathered and evaluated the information submitted. Based on my inquiry of the person or persons who manage the system, or those directly responsible for gathering the information, or the immediate supervisor of such person(s), the information submitted is, to the best of my knowledge and belief, true, accurate, and complete. I am aware that there are significant penalties for submitting false information, including the possibility of fine and imprisonment for knowing violations.

### **Cow Palace, LLC**

Signature \_\_\_\_\_

Name: Adam Dolsen

Title: Member

Date: \_\_\_\_\_





## **FIGURES**



The information included on this graphic representation has been compiled from a variety of sources and is subject to change without notice. IES makes no representations or warranties, express or implied, as to accuracy, completeness, timeliness, or rights to the use of such information. This document is not intended for use as a land survey product nor is it designed or intended as a construction design document. The use or misuse of the information contained on this graphic representation is at the sole risk of the party using or misusing the information.

032415

IES\Projects\1408\0012\005\LWP\Figure 1.vsd



SCALE 1 : 6,000

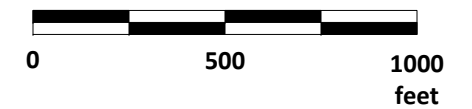

SOURCE: WASHINGTON 2011 NAIP ORTHO-IMAGERY-18 INCH DATA, WASHINGTON STATE ORTHOIMAGE PORTAL [HTTP://GEOGRAPHY.WA.GOV/ORTHO]



Project 1408-0012-005

March 2015

**LAGOON MAP**  
LAGOON WORK PLAN  
SDWA-10-2013-0080 / YAKIMA VALLEY DAIRIES  
COW PALACE DAIRY  
GRANGER, WASHINGTON

**FIGURE**

**1**



The information included on this graphic representation was compiled from a variety of sources and is subject to change without notice. IES makes no representations or warranties, express or implied, as to accuracy, completeness, timeliness, or rights to the use of such information. This document is not intended for use as a land survey product nor is it designed or intended as a construction design document. The use or misuse of the information contained on this graphic representation is at the sole risk of the party using or misusing the information.

IES\Projects\1408\0012\005\LWP\Figure 2.vsd 041815

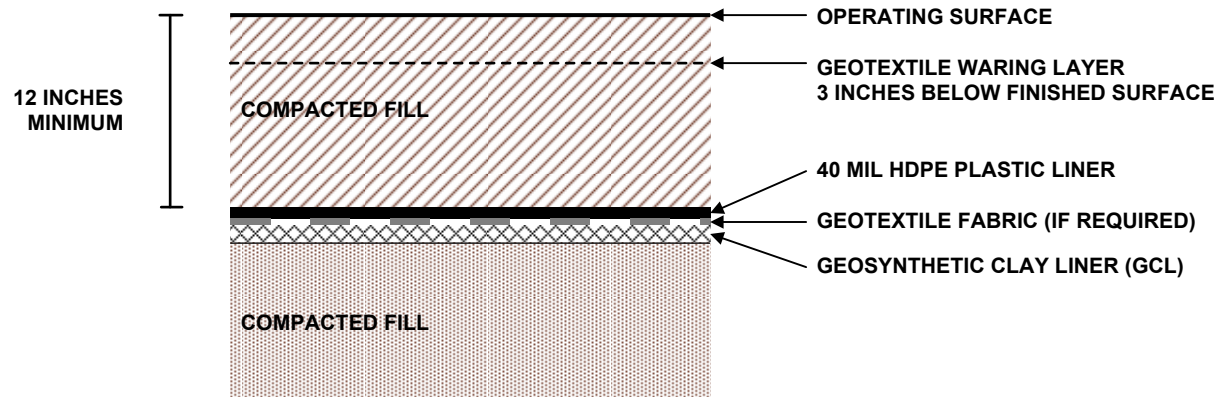
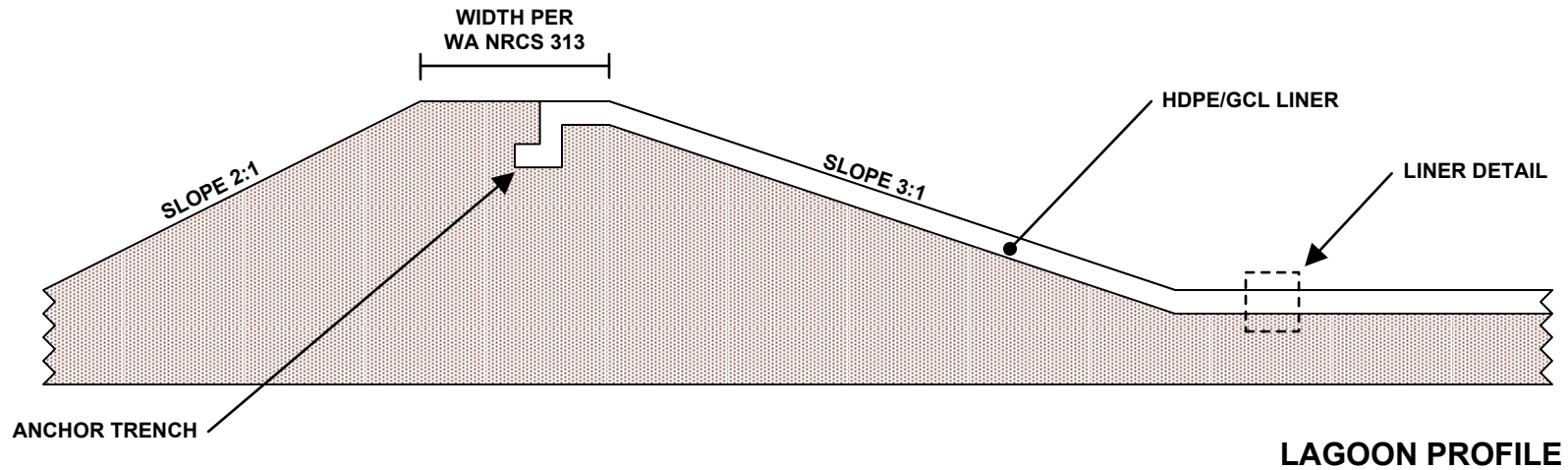

FIGURE NOT TO SCALE



**INLAND EARTH SCIENCES**

1408-0012-005

April 2015

**TYPICAL LAGOON LINER CROSS SECTION**

LAGOON WORK PLAN  
 SDWA-10-2013-0080 / YAKIMA VALLEY DAIRIES  
 COW PALACE DAIRY  
 GRANGER, WASHINGTON

**FIGURE**

**2**



**APPENDIX A**

**ASTM Standard D420  
Site Characterization for Engineering Design and  
Construction Purposes**



Designation: D 420 – 98

AMERICAN SOCIETY FOR TESTING AND MATERIALS  
100 Barr Harbor Dr., West Conshohocken, PA 19428  
Reprinted from the Annual Book of ASTM Standards. Copyright ASTM

# Standard Guide to Site Characterization for Engineering Design and Construction Purposes<sup>1</sup>

This standard is issued under the fixed designation D 420; the number immediately following the designation indicates the year of original adoption or, in the case of revision, the year of last revision. A number in parentheses indicates the year of last reapproval. A superscript epsilon ( $\epsilon$ ) indicates an editorial change since the last revision or reapproval.

## INTRODUCTION

Investigation and identification of subsurface materials involves both simple and complex techniques that may be accomplished by many different procedures and may be variously interpreted. These studies are frequently site specific and are influenced by geological and geographical settings, by the purpose of the investigation, by design requirements for the project proposed, and by the background, training, and experience of the investigator. This guide has been extensively rewritten and enlarged since the version approved in 1987. Material has been added for clarification and for expansion of concepts. Many new ASTM standards are referenced and a bibliography of non-ASTM references is appended.

This document is a guide to the selection of the various ASTM standards that are available for the investigation of soil, rock, and ground water for projects that involve surface or subsurface construction, or both. It is intended to improve consistency of practice and to encourage rational planning of a site characterization program. Since the subsurface conditions at a particular site are usually the result of a combination of natural, geologic, topographic, and climatic factors, and of historical modifications both natural and manmade, an adequate and internally consistent exploration program will allow evaluation of the results of these influences.

## 1. Scope

1.1 This guide refers to ASTM methods by which soil, rock, and ground water conditions may be determined. The objective of the investigation should be to identify and locate, both horizontally and vertically, significant soil and rock types and ground water conditions present within a given site area and to establish the characteristics of the subsurface materials by sampling or in situ testing, or both.

1.2 Laboratory testing of soil, rock, and ground water samples is specified by other ASTM standards not listed herein. Subsurface exploration for environmental purposes will be the subject of a separate ASTM document.

1.3 Prior to commencement of any intrusive exploration the site should be checked for underground utilities. Should evidence of potentially hazardous or otherwise contaminated materials or conditions be encountered in the course of the investigation, work should be interrupted until the circumstances have been evaluated and revised instructions issued before resumption.

1.4 The values stated in (SI) inch-pound units are to be regarded as the standard.

1.5 *This guide offers an organized collection of information or a series of options and does not recommend a specific course of action. This document cannot replace education or experience and should be used in conjunction with professional judgment. Not all aspects of this guide may be applicable in all circumstances. This ASTM standard is not intended to represent or replace the standard of care by which the adequacy of a given professional service must be judged, nor should this document be applied without consideration of a project's many unique aspects. The word "Standard" in the title of this document means only that the document has been approved through the ASTM consensus process.*

1.6 *This guide does not purport to address all of the safety concerns, if any, associated with its use. It is the responsibility of the user of this standard to establish appropriate safety and health practices and determine the applicability of regulatory limitations prior to use.*

## 2. Referenced Documents

### 2.1 ASTM Standards:

C 119 Terminology Relating to Dimension Stone<sup>2</sup>

C 294 Descriptive Nomenclature for Constituents of Natural Mineral Aggregates<sup>3</sup>

<sup>1</sup> This guide is under the jurisdiction of ASTM Committee D-18 on Soil and Rock and is the direct responsibility of Subcommittee D18.01 on Surface and Subsurface Characterization.

Current edition approved March 10, 1998. Published January 1999. Originally published as D 425 – 65 T. Last previous edition D 420 – 93.

<sup>2</sup> Annual Book of ASTM Standards, Vol 04.08.

<sup>3</sup> Annual Book of ASTM Standards, Vol 04.09.



D 420

- C 851 Practice for Estimating Scratch Hardness of Coarse Aggregate Particles<sup>3</sup>
- D 75 Practice for Sampling Aggregates<sup>4</sup>
- D 653 Terminology Relating to Soil, Rock, and Contained Fluids<sup>2</sup>
- D 1194 Test Method for Bearing Capacity of Soil for Static Load and Spread Footings<sup>2</sup>
- D 1195 Test Method for Repetitive Static Plate Load Tests of Soils and Flexible Pavement Components, for Use in Evaluation and Design of Airport and Highway Pavements<sup>2</sup>
- D 1196 Test Method for Nonrepetitive Static Plate Load Tests of Soils and Flexible Pavement Components, for Use in Evaluation and Design of Airport and Highway Pavements<sup>2</sup>
- D 1452 Practice for Soil Investigation and Sampling by Auger Borings<sup>2</sup>
- D 1586 Test Method for Penetration Test and Split-Barrel Sampling of Soils<sup>2</sup>
- D 1587 Practice for Thin-Walled Tube Sampling of Soils<sup>2</sup>
- D 2113 Practice for Rock Core Drilling, and Sampling of Rock for Site Investigation<sup>2</sup>
- D 2487 Classification of Soils for Engineering Purposes (Unified Soil Classification System)<sup>2</sup>
- D 2488 Practice for Description and Identification of Soils (Visual-Manual Procedure)<sup>2</sup>
- D 2573 Test Method for Field Vane Shear Test in Cohesive Soil<sup>2</sup>
- D 2607 Classification of Peats, Mosses, Humus, and Related Products<sup>2</sup>
- D 3017 Test Method for Water Content of Soil and Rock in Place by Nuclear Methods (Shallow Depth)<sup>2</sup>
- D 3213 Practices for Handling, Storing, and Preparing Soft Undisturbed Marine Soil<sup>2</sup>
- D 3282 Classification of Soils and Soil-Aggregate Mixtures for Highway Construction Purposes<sup>2</sup>
- D 3385 Test Method for Infiltration Rate of Soils in Field Using Double-Ring Infiltrometers<sup>2</sup>
- D 3404 Guide to Measuring Matric Potential in the Vadose Zone Using Tensiometers<sup>2</sup>
- D 3441 Test Method for Deep, Quasi-Static, Cone and Friction-Cone Penetration Tests of Soil<sup>2</sup>
- D 3550 Practice for Ring-lined Barrel Sampling of Soils<sup>2</sup>
- D 3584 Practice for Indexing Papers and Reports on Soil and Rock for Engineering Purposes<sup>2</sup>
- D 4083 Practice for Description of Frozen Soils (Visual-Manual Procedure)<sup>2</sup>
- D 4220 Practices for Preserving and Transporting Soil Samples<sup>2</sup>
- D 4394 Test Method for Determining the In Situ Modulus of Deformation of Rock Mass Using the Rigid Plate Loading Method<sup>2</sup>
- D 4395 Test Method for Determining the In Situ Modulus of Deformation of Rock Mass Using the Flexible Plate Loading Method<sup>2</sup>
- D 4403 Practice for Extensometers Used in Rock<sup>2</sup>
- D 4428 Test Methods for Crosshole Seismic Testing<sup>2</sup>
- D 4429 Test Method for CBR (California Bearing Ratio) of Soils in Place<sup>2</sup>
- D 4452 Methods for X-Ray Radiography of Soil Samples<sup>2</sup>
- D 4506 Test Method for Determining the In Situ Modulus of Deformation of Rock Mass Using a Radial Jacking Test<sup>2</sup>
- D 4544 Practice for Estimating Peat Deposit Thickness<sup>2</sup>
- D 4553 Test Method for Determining the In Situ Creep Characteristics of Rock<sup>2</sup>
- D 4554 Test Method for In Situ Determination of Direct Shear Strength of Rock Discontinuities<sup>2</sup>
- D 4555 Test Method for Determining Deformability and Strength of Weak Rock by an In Situ Uniaxial Compressive Test<sup>2</sup>
- D 4622 Test Method for Rock Mass Monitoring Using Inclinometers<sup>2</sup>
- D 4623 Test Method for Determination of In Situ Stress in Rock Mass by Overcoring Method—USBM Borehole Deformation Gage<sup>2</sup>
- D 4630 Test Method for Determining Transmissivity and Storativity of Low Permeability Rocks by In Situ Measurements Using the Constant Head Injection Test<sup>2</sup>
- D 4631 Test Method for Determining Transmissivity and Storativity of Low Permeability Rocks by In Situ Measurements Using the Pressure Pulse Technique<sup>2</sup>
- D 4633 Test Method for Stress Wave Energy Measurement for Dynamic Penetrometer Testing Systems<sup>2</sup>
- D 4645 Test Method for Determination of the In Situ Stress in Rock Using the Hydraulic Fracturing Method<sup>2</sup>
- D 4700 Guide for Soil Sampling from the Vadose Zone<sup>2</sup>
- D 4719 Test Method for Pressuremeter Testing in Soils<sup>2</sup>
- D 4729 Test Method for In Situ Stress and Modulus of Deformation Using the Flatjack Method<sup>2</sup>
- D 4750 Test Method for Determining Subsurface Liquid Levels in a Borehole or Monitoring Well (Observation Well)<sup>2</sup>
- D 4879 Guide for Geotechnical Mapping of Large Underground Openings in Rock<sup>2</sup>
- D 4971 Test Method for Determining the In Situ Modulus of Deformation of Rock Using the Diametrically Loaded 76-mm (3-in.) Borehole Jack<sup>5</sup>
- D 5079 Practices for Preserving and Transporting Rock Core Samples<sup>5</sup>
- D 5088 Practice for Decontamination of Field Equipment Used at Nonradioactive Waste Sites<sup>5</sup>
- D 5092 Practice for Design and Installation of Ground Water Monitoring Wells in Aquifers<sup>5</sup>
- D 5093 Test Method for Field Measurement of Infiltration Rate Using a Double-Ring Infiltrometer with a Sealed-Inner Ring<sup>5</sup>
- D 5126 Guide for Comparison of Field Methods for Determining Hydraulic Conductivity in the Vadose Zone<sup>5</sup>
- D 5195 Test Method for Density of Soil and Rock In-Place at Depths Below the Surface by Nuclear Methods<sup>5</sup>
- E 177 Practice for the Use of the Terms Precision and Bias

<sup>4</sup> Annual Book of ASTM Standards, Vol 04.03.

<sup>5</sup> Annual Book of ASTM Standards, Vol 04.09.



D 420

- in ASTM Test Methods<sup>6</sup>  
 E 380 Practice for the Use of the International System of Units (SI) (the Modernized Metric System)<sup>6</sup>  
 G 51 Test Method for pH of Soil for Use in Corrosion Testing<sup>7</sup>  
 G 57 Method for Field Measurement of Soil Resistivity Using the Wenner Four-Electrode Method<sup>7,8</sup>

### 3. Significance and Use

3.1 An adequate soil, rock, and ground water investigation will provide pertinent information for decision making on one or more of the following subjects:

3.1.1 Optimum location of the structure, both vertically and horizontally, within the area of the proposed construction.

3.1.2 Location and preliminary evaluation of suitable borrow and other local sources of construction aggregates.

3.1.3 Need for special excavating and dewatering techniques with the corresponding need for information, even if only approximate, on the distribution of soil water content or pore pressure, or both, and on the piezometric heads and apparent permeability (hydraulic conductivity) of the various subsurface strata.

3.1.4 Investigation of slope stability in natural slopes, cuts, and embankments.

3.1.5 Conceptual selection of embankment types and hydraulic barrier requirements.

3.1.6 Conceptual selection of alternate foundation types and elevations of the corresponding suitable bearing strata.

3.1.7 Development of additional detailed subsurface investigations for specific structures or facilities.

3.2 The investigation may require the collection of sufficiently large soil and rock samples of such quality as to allow adequate testing to determine the soil or rock classification or mineralogic type, or both, and the engineering properties pertinent to the proposed design.

3.3 This guide is not meant to be an inflexible description of investigation requirements; methods defined by other ASTM standards or non-ASTM techniques may be appropriate in some circumstances. The intent is to provide a checklist to assist in the design of an exploration/investigation plan.

### 4. Reconnaissance of Project Area

4.1 Available technical data from the literature or from personal communication should be reviewed before any field program is started. These include, but are not limited to, topographic maps, aerial photography, satellite imagery, geologic maps, statewide or county soil surveys and mineral resource surveys, and engineering soil maps covering the proposed project area. Reports of subsurface investigations of nearby or adjacent projects should be studied.

NOTE 1—While certain of the older maps and reports may be obsolete and of limited value in the light of current knowledge, a comparison of the old with the new will often reveal valuable information.

<sup>6</sup> *Annual Book of ASTM Standards*, Vol 14.02.

<sup>7</sup> *Annual Book of ASTM Standards*, Vol 03.02.

<sup>8</sup> The boldface numbers in parentheses refer to the list of references at the end of this standard.

4.1.1 The United States Geological Survey and the geological surveys of the various states are the principal sources of geologic maps and reports on mineral resources and ground water.

4.1.2 United States Department of Agriculture Soil Conservation Service soil surveys, where available and of recent date, should enable the investigator to estimate the range in soil profile characteristics to depths of 5 or 6 ft (1.5 or 2 m) for each soil mapped.

NOTE 2—Each soil type has a distinctive soil profile due to age, parent material, relief, climatic condition, and biological activity. Consideration of these factors can assist in identifying the various soil types, each requiring special engineering considerations and treatment. Similar engineering soil properties are often found where similar soil profiles characteristics exist. Changes in soil properties in adjacent areas often indicate changes in parent material or relief.

4.2 In areas where descriptive data are limited by insufficient geologic or soil maps, the soil and rock in open cuts in the vicinity of the proposed project should be studied and various soil and rock profiles noted. Field notes of such studies should include data outlined in 10.6.

4.3 Where a preliminary map covering the area of the project is desired, it can be prepared on maps compiled from aerial photography that show the ground conditions. The distribution of the predominant soil and rock deposits likely to be encountered during the investigation may be shown using data obtained from geologic maps, landform analysis and limited ground reconnaissance. Experienced photo-interpreters can deduce much subsurface data from a study of black and white, color, and infrared photographs because similar soil or rock conditions, or both, usually have similar patterns of appearance in regions of similar climate or vegetation.

NOTE 3—This preliminary map may be expanded into a detailed engineering map by locating all test holes, pits, and sampling stations and by revising boundaries as determined from the detailed subsurface survey.

4.4 In areas where documentary information is insufficient, some knowledge of subsurface conditions may be obtained from land owners, local well drillers, and representatives of the local construction industry.

### 5. Exploration Plan

5.1 Available project design and performance requirements must be reviewed prior to final development of the exploration plan. Preliminary exploration should be planned to indicate the areas of conditions needing further investigation. A complete soil, rock, and ground water investigation should encompass the following activities:

5.1.1 Review of available information, both regional and local, on the geologic history, rock, soil, and ground water conditions occurring at the proposed location and in the immediate vicinity of the site.

5.1.2 Interpretation of aerial photography and other remote sensing data.

5.1.3 Field reconnaissance for identification of surficial geologic conditions, mapping of stratigraphic exposures and outcrops, and examination of the performance of existing structures.

5.1.4 On site investigation of the surface and subsurface materials by geophysical surveys, borings, or test pits.





5.1.5 Recovery of representative disturbed samples for laboratory classification tests of soil, rock, and local construction material. These should be supplemented by undisturbed specimens suitable for the determination of those engineering properties pertinent to the investigation.

5.1.6 Identification of the position of the ground water table, or water tables, if there is perched ground water, or of the piezometric surfaces if there is artesian ground water. The variability of these positions in both short and long time frames should be considered. Color mottling of the soil strata may be indicative of long-term seasonal high ground water positions.

5.1.7 Identification and assessment of the location of suitable foundation material, either bedrock or satisfactory load-bearing soils.

5.1.8 Field identification of soil sediments, and rock, with particular reference to type and degree of decomposition (for example, saprolite, karst, decomposing or slaking shales), the depths of their occurrence and the types and locations of their structural discontinuities.

5.1.9 Evaluation of the performance of existing installations, relative to their structure foundation material and environment in the immediate vicinity of the proposed site.

## 6. Equipment and Procedures for Use in Exploration

6.1 *Pertinent ASTM Standards*—Practices D 1452, D 2113, D 4544, D 5088, D 5092; Method D 1586; and Test Methods D 4622, D 4633, D 4750.

6.2 The type of equipment required for a subsurface investigation depends upon various factors, including the type of subsurface material, depth of exploration, the nature of the terrain, and the intended use of the data.

6.2.1 *Hand Augers, Hole Diggers, Shovels, and Push Tube Samplers* are suitable for exploration of surficial soils to depths of 3 to 15 ft (1 to 5 m).

6.2.2 *Earth Excavation Equipment*, such as backhoes, draglines, and drilled pier augers (screw or bucket) can allow in situ examination of soil deposits and sampling of materials containing very large particles. The investigator should be aware of the possibility of permanent disturbance of potential bearing strata by unbalanced pore pressure in test excavations.

6.2.3 Soil and rock boring and drilling machines and proofing devices may be used to depths of 200 to 300 ft in soil and to a much greater depth in rock.

6.2.4 Well drilling equipment may be suitable for deep geologic exploration. Normally samples are in the form of sand-sized cuttings captured from the return flow, but coring devices are available.

## 7. Geophysical Exploration

7.1 *Pertinent ASTM Standards*—Test Methods D 4428 and Method G 57.

7.2 Remote sensing techniques may assist in mapping the geological formations and for evaluating variations in soil and rock properties. Satellite and aircraft spectral mapping tools, such as LANDSAT, may be used to find and map the areal extent of subsurface materials and geologic structure. Interpretation of aircraft photographs and satellite imagery can locate and identify significant geologic features that may be indicative of faults and fractures. Some ground control is generally

required to verify information derived from remote sensing data.

7.3 Geophysical survey methods may be used to supplement borehole and outcrop data and to interpolate between holes. Seismic, ground penetrating radar, and electrical resistivity methods can be particularly valuable when distinct differences in the properties of contiguous subsurface materials are indicated.

7.4 Shallow seismic refraction/reflection and ground penetrating radar techniques can be used to map soil horizons and depth profiles, water tables, and depth to bedrock in many situations, but depth penetration and resolution vary with local conditions. Electromagnetic induction, electrical resistivity, and induced polarization (or complex resistivity) techniques may be used to map variations in water content, clay horizons, stratification, and depth to aquifer/bedrock. Other geophysical techniques such as gravity, magnetic, and shallow ground temperature methods may be useful under certain specific conditions. Deep seismic and electrical methods are routinely used for mapping stratigraphy and structure of rock in conjunction with logs. Crosshole shear wave velocity measurements can provide soil and rock parameters for dynamic analyses.

7.4.1 The seismic refraction method may be especially useful in determining depth to, or rippability of, rock in locations where successively denser strata are encountered.

7.4.2 The seismic reflection method may be useful in delineating geological units at depths below 10 ft (3 m). It is not constrained by layers of low seismic velocity and is especially useful in areas of rapid stratigraphic change.

7.4.3 The electrical resistivity method, Method G 57, may be similarly useful in determining depth to rock and anomalies in the stratigraphic profile, in evaluating stratified formations where a denser stratum overlies a less dense stratum, and in location of prospective sand-gravel or other sources of borrow material. Resistivity parameters also are required for the design of grounding systems and cathodic protection for buried structures.

7.4.4 The ground penetrating radar method may be useful in defining soil and rock layers and manmade structures in the depth range of 1 to 30 ft ( $\frac{1}{3}$  to 10 m).

NOTE 4—Surface geophysical investigations can be a useful guide in determining boring or test hole locations. If at all possible, the interpretation of geophysical studies should be verified by borings or test excavations.

## 8. Sampling

8.1 *Pertinent ASTM Standards*—Practices D 75, D 1452, D 1587, D 2113, D 3213, D 3550, D 4220, D 5079; Test Method D 1586; Methods D 4452; and Guide D 4700.

8.2 Obtain samples that adequately represent each subsurface material that is significant to the project design and construction. The size and type of sample required is dependent upon the tests to be performed, the relative amount of coarse particles present, and the limitations of the test equipment to be used.

NOTE 5—The size of disturbed or bulk samples for routine tests may vary at the discretion of the geotechnical investigator, but the following quantities are suggested as suitable for most materials: (a) Visual





D 420

classification—50 to 500 g (2 oz to 1 lb); (b) Soil constants and particle size analysis of non-gravelly soil—500 g to 2.5 kg (1 to 5 lb); (c) Soil compaction tests and sieve analysis of gravelly soils—20 to 40 kg (40 to 80 lb); (d) Aggregate manufacture or aggregate properties tests—50 to 200 kg (100 to 400 lb).

8.3 Accurately identify each sample with the boring, test hole, or test pit number and depth below reference ground surface from which it was taken. Place a waterproof identification tag inside the container, securely close the container, protect it to withstand rough handling, and mark it with proper identification on the outside. Keep samples for natural water content determination in sealed containers to prevent moisture loss. When drying of samples may affect classification or engineering properties test results, protect them to minimize moisture loss. Practices D 4220 and D 5079 address the transportation of samples from field to laboratory. Most of the titles of the referenced standards are self-explanatory, but some need elaboration for the benefit of the users of this guide.

8.3.1 Practice D 75 describes the sampling of coarse and fine aggregates for the preliminary investigation of a potential source of supply.

8.3.2 Practice D 1452 describes the use of augers in soil investigations and sampling where disturbed soil samples can be used. Depths of auger investigations are limited by ground water conditions, soil characteristics, and equipment used.

8.3.3 Test Method D 1586 describes a procedure to obtain representative soil samples for identification and classification laboratory tests.

8.3.4 Practice D 1587 describes a procedure to recover relatively undisturbed soil samples suitable for laboratory testing.

8.3.5 Practice D 2113 describes a procedure to recover intact samples of rock and certain soils too hard to sample by Test Method D 1586 or Practice D 1587.

8.3.6 Practice D 3550 describes a procedure for the recovery of moderately disturbed, representative samples of soil for classification testing and, in some cases, shear or consolidation testing.

## 9. Classification of Earth Materials

9.1 *Pertinent ASTM Standards*—Terminology C 119; Descriptive Nomenclature C 294; Classifications D 2487, D 2607, D 3282; Practices D 2488, D 4083.

9.2 Additional description of samples of soil and rock may be added after submission to the laboratory for identification and classification tests in accordance with one or more ASTM laboratory standards or other applicable references, or both. Section 10.6.3 discusses the use, for identification and for classification purposes, of some of the standards listed in 9.1.

## 10. Determination of Subsurface Conditions

10.1 Subsurface conditions are positively defined only at the individual test pit, hole, boring, or open cut examined. Conditions between observation points may be significantly different from those encountered in the exploration. A stratigraphic profile can be developed by detailed investigations only where determinations of a continuous relationship of the depths and locations of various types of soil and rock can be inferred. This phase of the investigation may be implemented by plotting logs

of soil and rock exposures in walls of excavations or cut areas and by plotting logs of the test borings. Then one may interpolate between, and extrapolate a reasonable distance beyond, these logs. The spacing of these investigations should depend on the geologic complexity of the project area and on the importance of soil and rock continuity to the project design. Exploration should be deep enough to identify all strata that might be significantly affected by the proposed use of the site and to develop the engineering data required to allow analysis of the items listed in Section 4 for each project.

NOTE 6—Plans for a program of intrusive subsurface investigation should consider possible requirements for permits for installation and proper closure of bore holes and wells at the completion of the investigation.

10.2 The depth of exploratory borings or test pits for roadbeds, airport paving, or vehicle parking areas should be to at least 5 ft (1.5 m) below the proposed subgrade elevation. Special circumstances may increase this depth. Borings for structures, excavations, or embankments should extend below the level of significant stress or ground water influence from the proposed load as determined by subsurface stress analysis.

10.3 When project construction or performance of the facility may be affected by either previous water-bearing materials or impervious materials that can block internal drainage, borings should extend sufficiently to determine those engineering and hydrogeologic properties that are relevant to the project design.

10.4 In all borrow areas the borings or test pits should be sufficient in number and depth to outline the required quantities of material meeting the specified quality requirements.

10.5 Where frost penetration or seasonal desiccation may be significant in the behavior of soil and rock, borings should extend well below the depth from finished grade of the anticipated active zone.

10.6 Exploration records shall be kept in a systematic manner for each project. Such records shall include:

10.6.1 Description of each site or area investigated. Each test hole, boring, test pit, or geophysical test site shall be clearly located (horizontally and vertically) with reference to some established coordinate system, datum, or permanent monument.

10.6.2 Logs of each test hole, boring, test pit, or cut surface exposure shall show clearly the field description and location of each material and any water encountered, either by symbol or word description. Reference to a Munsell color chart designation is a substantial aid to an accurate description of soil and rock materials.

NOTE 7—Color photographs of rock cores, soil samples, and exposed strata may be of considerable value. Each photograph should include an identifying number or symbol, a date, and reference scale.

10.6.3 Identification of all soils based on Classification D 2487, Practice D 2488, Classification D 2607, or Practice D 4083. Identification of rock materials based on Terminology C 119, Descriptive Nomenclature C 294, or Practice C 851. Classification of soil and rock is discussed in Section 9.

10.6.4 Location and description of seepage and water-bearing zones and records of piezometric elevations found in each hole, boring, piezometer, or test pit.



10.6.5 The results and precise locations of in situ test results such as the penetration resistance or vane shear discussed in 8.3, plate load tests, or other in situ test-engineering properties of soils or rock.

10.6.6 Percentage of core recovery and rock quality designation in core drilling as outlined in 8.3.5.

10.6.7 Graphical presentation of field and laboratory and its interpretation facilitates comprehensive understanding subsurface conditions.

## 11. In Situ Testing

11.1 *Pertinent ASTM Standards*—Test Methods D 1194, D 1195, D 1196, D 1586, D 2573, D 3017, D 3441, D 3885, D 4394, D 4395, D 4429, D 4506, D 4553, D 4554, D 4555, D 4623, D 4630, D 4631, D 4645, D 4719, D 4729, D 4971, D 5093, D 5195, G 51; Guides D 3404, D 5126; and Practice D 4403.

11.2 In situ testing is useful for: (a) measurement of soil parameters in their undisturbed condition with all of the restraining or loading effects, or both, of the surrounding soil or rock mass active, and (b) for rapid or closely spaced measurements, or both, of earth properties without the necessity of sampling. Most of the titles of the various referenced standards are self-explanatory, but some need elaboration for the users of this guide.

11.2.1 Test Method D 1586 describes a penetration test that has been correlated by many authors with various strength properties of soils.

11.2.2 Test Method D 2573 describes a procedure to measure the in situ unit shear resistance of cohesive soils by rotation of a four-bladed vane in a horizontal plane.

11.2.3 Test Method D 3441 describes the determination of the end bearing and side friction components of the resistance to penetration of a conical penetrometer into a soil mass.

11.2.4 Practice D 4403 describes the application of various types of extensometers used in the field of rock mechanics.

11.2.5 Test Method D 4429 describes the field determination of the California Bearing Ratio for soil surfaces in situ to be used in the design of pavement systems.

11.2.6 Test Method D 4719 describes an in situ stress-strain test performed on the walls of a bore hole in soil.

NOTE 8—Other standards for in situ test procedures and automated data collection are being prepared by ASTM Committee D-18 for publication at a later date.

## 12. Interpretation of Results

12.1 Interpret the results of an investigation in terms of actual findings and make every effort to collect and include all field and laboratory data from previous investigations in the same area. Extrapolation of data into local areas not surveyed and tested should be made only for conceptual studies. Such extrapolation can be done only where geologically uniform stratigraphic and structural relationships are known to exist on the basis of other data. Cross sections may be developed as part of the site characterization if required to demonstrate the site conditions.

12.1.1 Cross sections included with the presentation of basic data from the investigation should be limited to the ground surface profile and the factual subsurface data obtained

at specific exploration locations. Stratigraphic units between the locations of intrusive explorations should only be indicated if supported by continuous geophysical profiles.

12.1.2 Cross sections showing interpretations of stratigraphic units and other conditions between intrusive explorations but without support of continuous geophysical profiles should be presented in an interpretative report appendix or in a separate interpretative report. The interpretive cross sections must be accompanied by notes describing anomalies or otherwise significant variations in the site conditions that should be anticipated for the intended design or construction activities.

NOTE 9—Additional exploration should be considered if there is not sufficient knowledge to develop interpretative cross sections, with realistic descriptions of anticipated variations in subsurface conditions, to meet project requirements.

12.2 Subject to the restrictions imposed by state licensing law, recommendations for design parameters can be made only by professional engineers and geologists specializing in the field of geotechnical engineering and familiar with purpose, conditions, and requirements of the study. Soil mechanics, rock mechanics, and geomorphological concepts must be combined with a knowledge of geotechnical engineering or hydrogeology to make a complete application of the soil, rock, and ground water investigation. Complete design recommendations may require a more detailed study than that discussed in this guide.

12.3 Delineate subsurface profiles only from actual geophysical, test-hole, test-pit, or cut-surface data. Interpolation between locations should be made on the basis of available geologic knowledge of the area and should be clearly identified. The use of geophysical techniques as discussed in 7.2 is a valuable aid in such interpolation. Geophysical survey data should be identified separately from sample data or in situ test data.

## 13. Report

13.1 *Pertinent ASTM Standards*—Terminology D 653; Practices D 3584, E 177, E 380; and Guide D 4879.

13.2 The report of a subsurface investigation shall include:

13.2.1 The location of the area investigated in terms pertinent to the project. This may include sketch maps or aerial photos on which the test pits, bore holes, and sample areas are located, as well as geomorphological data relevant to the determination of the various soil and rock types. Such data includes elevation contours, streambeds, sink holes, cliffs, and the like. Where feasible, include in the report a geologic map or an agronomic soils map, or both, of the area investigated.

13.2.2 A description of the investigation procedures, including all borings and testhole logs, graphic presentation of all compaction, consolidation, or load test data tabulation of all laboratory test results, and graphical interpretations of geophysical measurements.

13.2.3 A summary of the findings obtained under Sections 4, 10, and 12, using subhead titles for the respective sections and appropriate recommendations and disclaimers for the use of the report.

## 14. Precision and Bias

14.1 This guide provides qualitative data only; therefore, a precision and bias statement is not applicable.



D 420

## 15. Keywords

15.1 explorations; feasibility studies; field investigations; foundation investigations; geological investigations; geophysical investigation; ground water; hydrologic investigations;

maps; preliminary investigations; reconnaissance surveys; sampling; site investigations (see Practice D 3584); soil surveys; subsurface investigations

## REFERENCES

- (1) *Engineering Geology Field Manual*, U.S. Bureau of Reclamation, 1989.
- (2) Dietrich, R. V., Dutro, J. V., Jr., and Foose, R. M., (Compilers), "AGI Data Sheets for Geology in Field, Laboratory, and Office," Second Edition, American Geological Institute, 1982.
- (3) Pelsner, A. (Ed.), "Manual on Subsurface Investigations," American Association of State Highway and Transportation Officials, Washington, DC.
- (4) Shuter, E. and Teasdale, W. E., "Applications of Drilling, Coring and Sampling Techniques to Test Holes and Wells," Techniques of Water-Resources Investigation, Book 2, U.S. Geological Survey, Washington, DC, 1989.
- (5) Keys, W. S., "Borehole Geophysics Applied to Ground Water Investigations," U.S Geological Survey Open-File Report R87-539, Denver, CO, 1988.
- (6) Dowding, C. H. (Ed.), "Site Characterization Exploration," American Society of Civil Engineers, Proceedings of Specialty Workshop, New York, NY, 1978.
- (7) "Earth Manual," U.S. Bureau of Reclamation, Denver, CO.
- (8) "Engineering and Design—Geotechnical Investigation Engineer Manual," EM 1110-1-1804, Headquarters, Department of the Army, Washington, DC, 1984.
- (9) "Agricultural Handbook, No. 436, Soil Taxonomy," Soil Conservation Service, U.S. Dept. of Agriculture, U.S. Printing Office, Washington, DC, December, 1975.

*The American Society for Testing and Materials takes no position respecting the validity of any patent rights asserted in connection with any item mentioned in this standard. Users of this standard are expressly advised that determination of the validity of any such patent rights, and the risk of infringement of such rights, are entirely their own responsibility.*

*This standard is subject to revision at any time by the responsible technical committee and must be reviewed every five years and if not revised, either reapproved or withdrawn. Your comments are invited either for revision of this standard or for additional standards and should be addressed to ASTM Headquarters. Your comments will receive careful consideration at a meeting of the responsible technical committee, which you may attend. If you feel that your comments have not received a fair hearing you should make your views known to the ASTM Committee on Standards, 100 Barr Harbor Drive, West Conshohocken, PA 19428.*



**APPENDIX B**

**ASTM Standard D422  
Particle-Size Analysis of Soils**



Designation: D422 – 63 (Reapproved 2007)<sup>ε1</sup>

## Standard Test Method for Particle-Size Analysis of Soils<sup>1</sup>

This standard is issued under the fixed designation D422; the number immediately following the designation indicates the year of original adoption or, in the case of revision, the year of last revision. A number in parentheses indicates the year of last reapproval. A superscript epsilon ( $\epsilon$ ) indicates an editorial change since the last revision or reapproval.

<sup>ε1</sup> NOTE—Editorial changes made throughout in February 2014.

### 1. Scope

1.1 This test method covers the quantitative determination of the distribution of particle sizes in soils. The distribution of particle sizes larger than 75  $\mu\text{m}$  (retained on the No. 200 sieve) is determined by sieving, while the distribution of particle sizes smaller than 75  $\mu\text{m}$  is determined by a sedimentation process, using a hydrometer to secure the necessary data (Note 1 and Note 2).

NOTE 1—Separation may be made on the No. 4 (4.75-mm), No. 40 (425- $\mu\text{m}$ ), or No. 200 (75- $\mu\text{m}$ ) sieve instead of the No. 10. For whatever sieve used, the size shall be indicated in the report.

NOTE 2—Two types of dispersion devices are provided: (1) a high-speed mechanical stirrer, and (2) air dispersion. Extensive investigations indicate that air-dispersion devices produce a more positive dispersion of plastic soils below the 20- $\mu\text{m}$  size and appreciably less degradation on all sizes when used with sandy soils. Because of the definite advantages favoring air dispersion, its use is recommended. The results from the two types of devices differ in magnitude, depending upon soil type, leading to marked differences in particle size distribution, especially for sizes finer than 20  $\mu\text{m}$ .

### 2. Referenced Documents

#### 2.1 ASTM Standards:<sup>2</sup>

D421 Practice for Dry Preparation of Soil Samples for Particle-Size Analysis and Determination of Soil Constants

E11 Specification for Woven Wire Test Sieve Cloth and Test Sieves

E100 Specification for ASTM Hydrometers

#### 2.2 ASTM Adjuncts:

Air-Jet Dispersion Cup for Grain-Size Analysis of Soil<sup>3</sup>

<sup>1</sup> This test method is under the jurisdiction of ASTM Committee D18 on Soil and Rock and is the direct responsibility of Subcommittee D18.03 on Texture, Plasticity and Density Characteristics of Soils.

Current edition approved Oct. 15, 2007. Published October 2007. Originally approved in 1935. Last previous edition approved in 2002 as D422 – 63 (2002)<sup>ε1</sup>. DOI: 10.1520/D0422-63R07E01.

<sup>2</sup> For referenced ASTM standards, visit the ASTM website, www.astm.org, or contact ASTM Customer Service at service@astm.org. For Annual Book of ASTM Standards volume information, refer to the standard's Document Summary page on the ASTM website.

<sup>3</sup> Available from ASTM International Headquarters. Order Adjunct No. ADJD0422.

### 3. Apparatus

3.1 *Balances*—A balance sensitive to 0.01 g for weighing the material passing a No. 10 (2.00-mm) sieve, and a balance sensitive to 0.1 % of the mass of the sample to be weighed for weighing the material retained on a No. 10 sieve.

3.2 *Stirring Apparatus*—Either apparatus A or B may be used.

3.2.1 Apparatus A shall consist of a mechanically operated stirring device in which a suitably mounted electric motor turns a vertical shaft at a speed of not less than 10 000 rpm without load. The shaft shall be equipped with a replaceable stirring paddle made of metal, plastic, or hard rubber, as shown in Fig. 1. The shaft shall be of such length that the stirring paddle will operate not less than 3/4 in. (19.0 mm) nor more than 1 1/2 in. (38.1 mm) above the bottom of the dispersion cup. A special dispersion cup conforming to either of the designs shown in Fig. 2 shall be provided to hold the sample while it is being dispersed.

3.2.2 Apparatus B shall consist of an air-jet dispersion cup (see drawing <sup>3</sup>) (Note 3) conforming to the general details shown in Fig. 3 (Note 4 and Note 5).

NOTE 3—The amount of air required by an air-jet dispersion cup is of the order of 2 ft<sup>3</sup>/min; some small air compressors are not capable of supplying sufficient air to operate a cup.

NOTE 4—Another air-type dispersion device, known as a dispersion tube, developed by Chu and Davidson at Iowa State College, has been shown to give results equivalent to those secured by the air-jet dispersion cups. When it is used, soaking of the sample can be done in the sedimentation cylinder, thus eliminating the need for transferring the slurry. When the air-dispersion tube is used, it shall be so indicated in the report.

NOTE 5—Water may condense in air lines when not in use. This water must be removed, either by using a water trap on the air line, or by blowing the water out of the line before using any of the air for dispersion purposes.

3.3 *Hydrometer*—An ASTM hydrometer, graduated to read in either specific gravity of the suspension or grams per litre of suspension, and conforming to the requirements for hydrometers 151H or 152H in Specifications E100. Dimensions of both hydrometers are the same, the scale being the only item of difference.

3.4 *Sedimentation Cylinder*—A glass cylinder essentially 18 in. (457 mm) in height and 2 1/2 in. (63.5 mm) in diameter, and



ASTM D422 – 63 (2007)<sup>e1</sup>

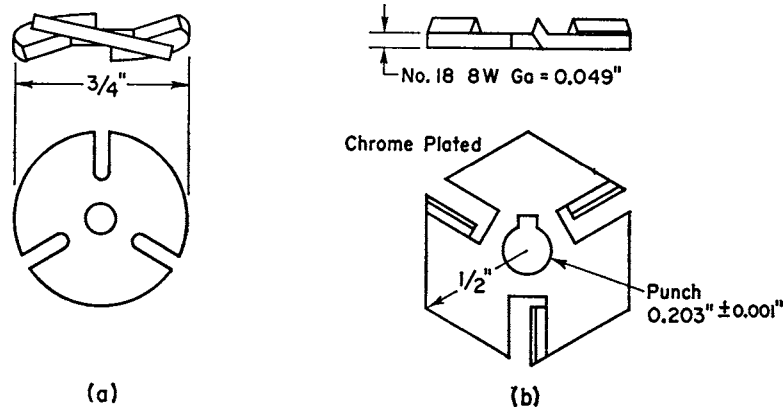

		Metric Equivalents			
in.	0.001	0.049	0.203	1/2	3/4
mm	0.03	1.24	5.16	12.7	19.0

FIG. 1 Detail of Stirring Paddles

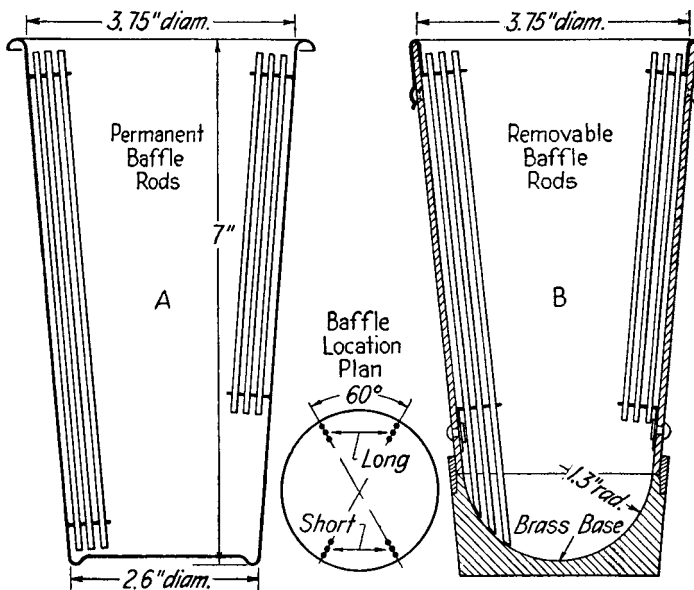

		Metric Equivalents		
in.	1.3	2.6	3.75	
mm	33	66	95.2	

FIG. 2 Dispersion Cups of Apparatus

NOTE 6—A set of sieves giving uniform spacing of points for the graph, as required in Section 17, may be used if desired. This set consists of the following sieves:

3-in. (75-mm)	No. 16 (1.18-mm)
1½-in. (37.5-mm)	No. 30 (600-µm)
¾-in. (19.0-mm)	No. 50 (300-µm)
⅜-in. (9.5-mm)	No. 100 (150-µm)
No. 4 (4.75-mm)	No. 200 (75-µm)
No. 8 (2.36-mm)	

3.7 *Water Bath or Constant-Temperature Room*—A water bath or constant-temperature room for maintaining the soil suspension at a constant temperature during the hydrometer analysis. A satisfactory water tank is an insulated tank that maintains the temperature of the suspension at a convenient constant temperature at or near 68°F (20°C). Such a device is illustrated in Fig. 4. In cases where the work is performed in a room at an automatically controlled constant temperature, the water bath is not necessary.

3.8 *Beaker*—A beaker of 250-mL capacity.

3.9 *Timing Device*—A watch or clock with a second hand.

4. Dispersing Agent

4.1 A solution of sodium hexametaphosphate (sometimes called sodium metaphosphate) shall be used in distilled or demineralized water, at the rate of 40 g of sodium hexametaphosphate/litre of solution (Note 7).

NOTE 7—Solutions of this salt, if acidic, slowly revert or hydrolyze back to the orthophosphate form with a resultant decrease in dispersive action. Solutions should be prepared frequently (at least once a month) or adjusted to pH of 8 or 9 by means of sodium carbonate. Bottles containing solutions should have the date of preparation marked on them.

4.2 All water used shall be either distilled or demineralized water. The water for a hydrometer test shall be brought to the temperature that is expected to prevail during the hydrometer test. For example, if the sedimentation cylinder is to be placed in the water bath, the distilled or demineralized water to be used shall be brought to the temperature of the controlled water bath; or, if the sedimentation cylinder is used in a room with controlled temperature, the water for the test shall be at the

marked for a volume of 1000 mL. The inside diameter shall be such that the 1000-mL mark is 36 ± 2 cm from the bottom on the inside.

3.5 *Thermometer*—A thermometer accurate to 1°F (0.5°C).

3.6 *Sieves*—A series of sieves, of square-mesh woven-wire cloth, conforming to the requirements of Specification E11. A full set of sieves includes the following (Note 6):

3-in. (75-mm)	No. 10 (2.00-mm)
2-in. (50-mm)	No. 20 (850-µm)
1½-in. (37.5-mm)	No. 40 (425-µm)
1-in. (25.0-mm)	No. 60 (250-µm)
¾-in. (19.0-mm)	No. 140 (106-µm)
⅜-in. (9.5-mm)	No. 200 (75-µm)
No. 4 (4.75-mm)	

ASTM D422 - 63 (2007)<sup>e1</sup>

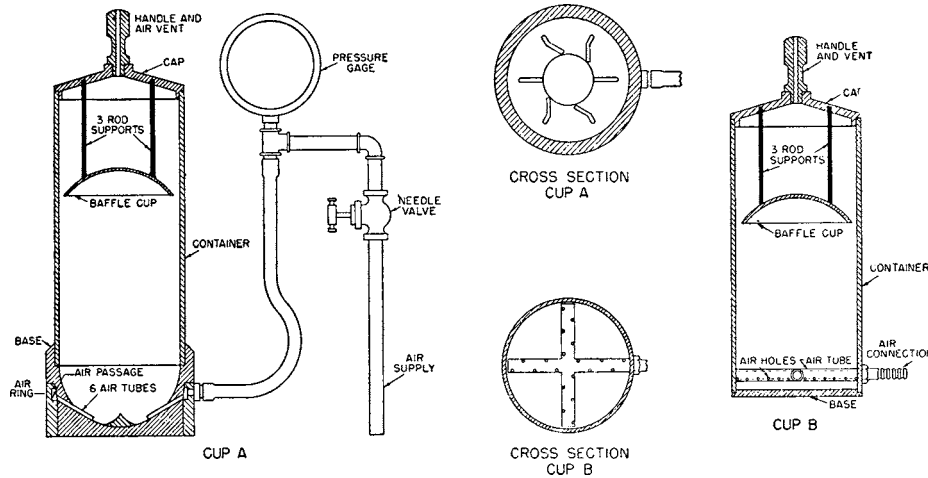
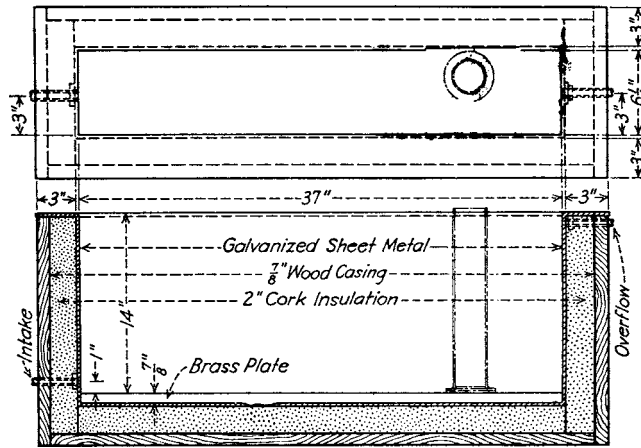

FIG. 3 Air-Jet Dispersion Cups of Apparatus B



		Metric Equivalents				
in.	7/8	1	3	6 1/4	14	37
mm	22.2	25.4	76.2	158.2	356	940

FIG. 4 Insulated Water Bath

temperature of the room. The basic temperature for the hydrometer test is 68°F (20°C). Small variations of temperature do not introduce differences that are of practical significance and do not prevent the use of corrections derived as prescribed.

5. Test Sample

5.1 Prepare the test sample for mechanical analysis as outlined in Practice D421. During the preparation procedure the sample is divided into two portions. One portion contains only particles retained on the No. 10 (2.00-mm) sieve while the other portion contains only particles passing the No. 10 sieve. The mass of air-dried soil selected for purpose of tests, as prescribed in Practice D421, shall be sufficient to yield quantities for mechanical analysis as follows:

5.1.1 The size of the portion retained on the No. 10 sieve shall depend on the maximum size of particle, according to the following schedule:

Nominal Diameter of Largest Particles, in. (mm)	Approximate Minimum Mass of Portion, g
3/8 (9.5)	500
1/4 (19.0)	1000
1 (25.4)	2000
1 1/2 (38.1)	3000
2 (50.8)	4000
3 (76.2)	5000

5.1.2 The size of the portion passing the No. 10 sieve shall be approximately 115 g for sandy soils and approximately 65 g for silt and clay soils.

5.2 Provision is made in Section 5 of Practice D421 for weighing of the air-dry soil selected for purpose of tests, the separation of the soil on the No. 10 sieve by dry-sieving and washing, and the weighing of the washed and dried fraction retained on the No. 10 sieve. From these two masses the percentages retained and passing the No. 10 sieve can be calculated in accordance with 12.1.

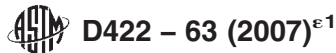

NOTE 8—A check on the mass values and the thoroughness of pulverization of the clods may be secured by weighing the portion passing the No. 10 sieve and adding this value to the mass of the washed and oven-dried portion retained on the No. 10 sieve.

## SIEVE ANALYSIS OF PORTION RETAINED ON NO. 10 (2.00-mm) SIEVE

### 6. Procedure

6.1 Separate the portion retained on the No. 10 (2.00-mm) sieve into a series of fractions using the 3-in. (75-mm), 2-in. (50-mm), 1½-in. (37.5-mm), 1-in. (25.0-mm), ¾-in. (19.0-mm), ⅜-in. (9.5-mm), No. 4 (4.75-mm), and No. 10 sieves, or as many as may be needed depending on the sample, or upon the specifications for the material under test.

6.2 Conduct the sieving operation by means of a lateral and vertical motion of the sieve, accompanied by a jarring action in order to keep the sample moving continuously over the surface of the sieve. In no case turn or manipulate fragments in the sample through the sieve by hand. Continue sieving until not more than 1 mass % of the residue on a sieve passes that sieve during 1 min of sieving. When mechanical sieving is used, test the thoroughness of sieving by using the hand method of sieving as described above.

6.3 Determine the mass of each fraction on a balance conforming to the requirements of 3.1. At the end of weighing, the sum of the masses retained on all the sieves used should equal closely the original mass of the quantity sieved.

## HYDROMETER AND SIEVE ANALYSIS OF PORTION PASSING THE NO. 10 (2.00-mm) SIEVE

### 7. Determination of Composite Correction for Hydrometer Reading

7.1 Equations for percentages of soil remaining in suspension, as given in 14.3, are based on the use of distilled or demineralized water. A dispersing agent is used in the water, however, and the specific gravity of the resulting liquid is appreciably greater than that of distilled or demineralized water.

7.1.1 Both soil hydrometers are calibrated at 68°F (20°C), and variations in temperature from this standard temperature produce inaccuracies in the actual hydrometer readings. The amount of the inaccuracy increases as the variation from the standard temperature increases.

7.1.2 Hydrometers are graduated by the manufacturer to be read at the bottom of the meniscus formed by the liquid on the stem. Since it is not possible to secure readings of soil suspensions at the bottom of the meniscus, readings must be taken at the top and a correction applied.

7.1.3 The net amount of the corrections for the three items enumerated is designated as the composite correction, and may be determined experimentally.

7.2 For convenience, a graph or table of composite corrections for a series of 1° temperature differences for the range of expected test temperatures may be prepared and used as needed. Measurement of the composite corrections may be made at two temperatures spanning the range of expected test

temperatures, and corrections for the intermediate temperatures calculated assuming a straight-line relationship between the two observed values.

7.3 Prepare 1000 mL of liquid composed of distilled or demineralized water and dispersing agent in the same proportion as will prevail in the sedimentation (hydrometer) test. Place the liquid in a sedimentation cylinder and the cylinder in the constant-temperature water bath, set for one of the two temperatures to be used. When the temperature of the liquid becomes constant, insert the hydrometer, and, after a short interval to permit the hydrometer to come to the temperature of the liquid, read the hydrometer at the top of the meniscus formed on the stem. For hydrometer 151H the composite correction is the difference between this reading and one; for hydrometer 152H it is the difference between the reading and zero. Bring the liquid and the hydrometer to the other temperature to be used, and secure the composite correction as before.

### 8. Hygroscopic Moisture

8.1 When the sample is weighed for the hydrometer test, weigh out an auxiliary portion of from 10 to 15 g in a small metal or glass container, dry the sample to a constant mass in an oven at 230 ± 9°F (110 ± 5°C), and weigh again. Record the masses.

### 9. Dispersion of Soil Sample

9.1 When the soil is mostly of the clay and silt sizes, weigh out a sample of air-dry soil of approximately 50 g. When the soil is mostly sand the sample should be approximately 100 g.

9.2 Place the sample in the 250-mL beaker and cover with 125 mL of sodium hexametaphosphate solution (40 g/L). Stir until the soil is thoroughly wetted. Allow to soak for at least 16 h.

9.3 At the end of the soaking period, disperse the sample further, using either stirring apparatus A or B. If stirring apparatus A is used, transfer the soil-water slurry from the beaker into the special dispersion cup shown in Fig. 2, washing any residue from the beaker into the cup with distilled or demineralized water (Note 9). Add distilled or demineralized water, if necessary, so that the cup is more than half full. Stir for a period of 1 min.

NOTE 9—A large size syringe is a convenient device for handling the water in the washing operation. Other devices include the wash-water bottle and a hose with nozzle connected to a pressurized distilled water tank.

9.4 If stirring apparatus B (Fig. 3) is used, remove the cover cap and connect the cup to a compressed air supply by means of a rubber hose. A air gage must be on the line between the cup and the control valve. Open the control valve so that the gage indicates 1 psi (7 kPa) pressure (Note 10). Transfer the soil-water slurry from the beaker to the air-jet dispersion cup by washing with distilled or demineralized water. Add distilled or demineralized water, if necessary, so that the total volume in the cup is 250 mL, but no more.

NOTE 10—The initial air pressure of 1 psi is required to prevent the soil-water mixture from entering the air-jet chamber when the mixture is transferred to the dispersion cup.



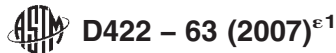

9.5 Place the cover cap on the cup and open the air control valve until the gage pressure is 20 psi (140 kPa). Disperse the soil according to the following schedule:

Plasticity Index	Dispersion Period, min
Under 5	5
6 to 20	10
Over 20	15

Soils containing large percentages of mica need be dispersed for only 1 min. After the dispersion period, reduce the gage pressure to 1 psi preparatory to transfer of soil-water slurry to the sedimentation cylinder.

## 10. Hydrometer Test

10.1 Immediately after dispersion, transfer the soil-water slurry to the glass sedimentation cylinder, and add distilled or demineralized water until the total volume is 1000 mL.

10.2 Using the palm of the hand over the open end of the cylinder (or a rubber stopper in the open end), turn the cylinder upside down and back for a period of 1 min to complete the agitation of the slurry (Note 11). At the end of 1 min set the cylinder in a convenient location and take hydrometer readings at the following intervals of time (measured from the beginning of sedimentation), or as many as may be needed, depending on the sample or the specification for the material under test: 2, 5, 15, 30, 60, 250, and 1440 min. If the controlled water bath is used, the sedimentation cylinder should be placed in the bath between the 2- and 5-min readings.

NOTE 11—The number of turns during this minute should be approximately 60, counting the turn upside down and back as two turns. Any soil remaining in the bottom of the cylinder during the first few turns should be loosened by vigorous shaking of the cylinder while it is in the inverted position.

10.3 When it is desired to take a hydrometer reading, carefully insert the hydrometer about 20 to 25 s before the reading is due to approximately the depth it will have when the reading is taken. As soon as the reading is taken, carefully remove the hydrometer and place it with a spinning motion in a graduate of clean distilled or demineralized water.

NOTE 12—It is important to remove the hydrometer immediately after each reading. Readings shall be taken at the top of the meniscus formed by the suspension around the stem, since it is not possible to secure readings at the bottom of the meniscus.

10.4 After each reading, take the temperature of the suspension by inserting the thermometer into the suspension.

## 11. Sieve Analysis

11.1 After taking the final hydrometer reading, transfer the suspension to a No. 200 (75- $\mu$ m) sieve and wash with tap water until the wash water is clear. Transfer the material on the No. 200 sieve to a suitable container, dry in an oven at  $230 \pm 9^\circ\text{F}$

( $110 \pm 5^\circ\text{C}$ ) and make a sieve analysis of the portion retained, using as many sieves as desired, or required for the material, or upon the specification of the material under test.

## CALCULATIONS AND REPORT

### 12. Sieve Analysis Values for the Portion Coarser than the No. 10 (2.00-mm) Sieve

12.1 Calculate the percentage passing the No. 10 sieve by dividing the mass passing the No. 10 sieve by the mass of soil originally split on the No. 10 sieve, and multiplying the result by 100. To obtain the mass passing the No. 10 sieve, subtract the mass retained on the No. 10 sieve from the original mass.

12.2 To secure the total mass of soil passing the No. 4 (4.75-mm) sieve, add to the mass of the material passing the No. 10 sieve the mass of the fraction passing the No. 4 sieve and retained on the No. 10 sieve. To secure the total mass of soil passing the  $\frac{3}{8}$ -in. (9.5-mm) sieve, add to the total mass of soil passing the No. 4 sieve, the mass of the fraction passing the  $\frac{3}{8}$ -in. sieve and retained on the No. 4 sieve. For the remaining sieves, continue the calculations in the same manner.

12.3 To determine the total percentage passing for each sieve, divide the total mass passing (see 12.2) by the total mass of sample and multiply the result by 100.

### 13. Hygroscopic Moisture Correction Factor

13.1 The hygroscopic moisture correction factor is the ratio between the mass of the oven-dried sample and the air-dry mass before drying. It is a number less than one, except when there is no hygroscopic moisture.

### 14. Percentages of Soil in Suspension

14.1 Calculate the oven-dry mass of soil used in the hydrometer analysis by multiplying the air-dry mass by the hygroscopic moisture correction factor.

14.2 Calculate the mass of a total sample represented by the mass of soil used in the hydrometer test, by dividing the oven-dry mass used by the percentage passing the No. 10 (2.00-mm) sieve, and multiplying the result by 100. This value is the weight  $W$  in the equation for percentage remaining in suspension.

14.3 The percentage of soil remaining in suspension at the level at which the hydrometer is measuring the density of the suspension may be calculated as follows (Note 13): For hydrometer 151H:

$$P = [(100000/W) \times G / (G - G_1)](R - G_1) \quad (1)$$

NOTE 13—The bracketed portion of the equation for hydrometer 151H is constant for a series of readings and may be calculated first and then multiplied by the portion in the parentheses.

For hydrometer 152H:

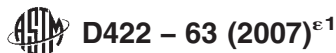

**TABLE 1 Values of Correction Factor,  $\alpha$ , for Different Specific Gravities of Soil Particles<sup>A</sup>**

Specific Gravity	Correction Factor <sup>A</sup>
2.95	0.94
2.90	0.95
2.85	0.96
2.80	0.97
2.75	0.98
2.70	0.99
2.65	1.00
2.60	1.01
2.55	1.02
2.50	1.03
2.45	1.05

<sup>A</sup> For use in equation for percentage of soil remaining in suspension when using Hydrometer 152H.

$$P = (Ra/W) \times 100 \quad (2)$$

where:

- $a$  = correction factor to be applied to the reading of hydrometer 152H. (Values shown on the scale are computed using a specific gravity of 2.65. Correction factors are given in [Table 1](#)),
- $P$  = percentage of soil remaining in suspension at the level at which the hydrometer measures the density of the suspension,
- $R$  = hydrometer reading with composite correction applied ([Section 7](#)),
- $W$  = oven-dry mass of soil in a total test sample represented by mass of soil dispersed (see [14.2](#)), g,
- $G$  = specific gravity of the soil particles, and
- $G_1$  = specific gravity of the liquid in which soil particles are suspended. Use numerical value of one in both instances in the equation. In the first instance any possible variation produces no significant effect, and in the second instance, the composite correction for  $R$  is based on a value of one for  $G_1$ .

## 15. Diameter of Soil Particles

15.1 The diameter of a particle corresponding to the percentage indicated by a given hydrometer reading shall be calculated according to Stokes' law ([Note 14](#)), on the basis that a particle of this diameter was at the surface of the suspension at the beginning of sedimentation and had settled to the level at which the hydrometer is measuring the density of the suspension. According to Stokes' law (see [Table 2](#)):

$$D = \sqrt{[30n/980(G - G_1)] \times L/T} \quad (3)$$

where:

- $D$  = diameter of particle, mm,
- $n$  = coefficient of viscosity of the suspending medium (in this case water) in poises (varies with changes in temperature of the suspending medium),
- $L$  = distance from the surface of the suspension to the level at which the density of the suspension is being measured, cm. (For a given hydrometer and sedimentation cylinder, values vary according to the hydrometer readings. This distance is known as effective depth (see [Table 2](#))),
- $T$  = interval of time from beginning of sedimentation to the taking of the reading, min,
- $G$  = specific gravity of soil particles, and
- $G_1$  = specific gravity (relative density) of suspending medium (value may be used as 1.000 for all practical purposes).

**NOTE 14**—Since Stokes' law considers the terminal velocity of a single sphere falling in an infinity of liquid, the sizes calculated represent the diameter of spheres that would fall at the same rate as the soil particles.

15.2 For convenience in calculations the above equation may be written as follows (see [Table 3](#)):

$$D = K\sqrt{L/T} \quad (5)$$

where:

- $K$  = constant depending on the temperature of the suspension and the specific gravity of the soil particles. Values of  $K$  for a range of temperatures and specific gravities are given in [Table 3](#). The value of  $K$  does not change for a series of readings constituting a test, while values of  $L$  and  $T$  do vary.

15.3 Values of  $D$  may be computed with sufficient accuracy, using an ordinary 10-in. slide rule.

**NOTE 15**—The value of  $L$  is divided by  $T$  using the  $A$ - and  $B$ -scales, the square root being indicated on the  $D$ -scale. Without ascertaining the value of the square root it may be multiplied by  $K$ , using either the  $C$ - or  $CI$ -scale.

## 16. Sieve Analysis Values for Portion Finer than No. 10 (2.00-mm) Sieve

16.1 Calculation of percentages passing the various sieves used in sieving the portion of the sample from the hydrometer test involves several steps. The first step is to calculate the mass of the fraction that would have been retained on the No. 10 sieve had it not been removed. This mass is equal to the total percentage retained on the No. 10 sieve (100 minus total percentage passing) times the mass of the total sample represented by the mass of soil used (as calculated in [14.2](#)), and the result divided by 100.

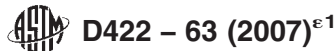

**TABLE 2 Values of Effective Depth Based on Hydrometer and Sedimentation Cylinder of Specified Sizes<sup>A</sup>**

Hydrometer 151H		Hydrometer 152H		Actual Hydrometer Reading	Effective Depth, L, cm
Actual Hydrometer Reading	Effective Depth, L, cm	Actual Hydrometer Reading	Effective Depth, L, cm		
1.000	16.3	0	16.3	31	11.2
1.001	16.0	1	16.1	32	11.1
1.002	15.8	2	16.0	33	10.9
1.003	15.5	3	15.8	34	10.7
1.004	15.2	4	15.6	35	10.6
1.005	15.0	5	15.5		
1.006	14.7	6	15.3	36	10.4
1.007	14.4	7	15.2	37	10.2
1.008	14.2	8	15.0	38	10.1
1.009	13.9	9	14.8	39	9.9
1.010	13.7	10	14.7	40	9.7
1.011	13.4	11	14.5	41	9.6
1.012	13.1	12	14.3	42	9.4
1.013	12.9	13	14.2	43	9.2
1.014	12.6	14	14.0	44	9.1
1.015	12.3	15	13.8	45	8.9
1.016	12.1	16	13.7	46	8.8
1.017	11.8	17	13.5	47	8.6
1.018	11.5	18	13.3	48	8.4
1.019	11.3	19	13.2	49	8.3
1.020	11.0	20	13.0	50	8.1
1.021	10.7	21	12.9	51	7.9
1.022	10.5	22	12.7	52	7.8
1.023	10.2	23	12.5	53	7.6
1.024	10.0	24	12.4	54	7.4
1.025	9.7	25	12.2	55	7.3
1.026	9.4	26	12.0	56	7.1
1.027	9.2	27	11.9	57	7.0
1.028	8.9	28	11.7	58	6.8
1.029	8.6	29	11.5	59	6.6
1.030	8.4	30	11.4	60	6.5
1.031	8.1				
1.032	7.8				
1.033	7.6				
1.034	7.3				
1.035	7.0				
1.036	6.8				
1.037	6.5				
1.038	6.2				

<sup>A</sup> Values of effective depth are calculated from the equation:

$$L = L_1 + 1/2 [L_2 - (V_B/A)] \quad (4)$$

where:

- $L$  = effective depth, cm,  
 $L_1$  = distance along the stem of the hydrometer from the top of the bulb to the mark for a hydrometer reading, cm,  
 $L_2$  = overall length of the hydrometer bulb, cm,  
 $V_B$  = volume of hydrometer bulb, cm<sup>3</sup>, and  
 $A$  = cross-sectional area of sedimentation cylinder, cm<sup>2</sup>

Values used in calculating the values in Table 2 are as follows:

For both hydrometers, 151H and 152H:

- $L_2$  = 14.0 cm  
 $V_B$  = 67.0 cm<sup>3</sup>  
 $A$  = 27.8 cm<sup>2</sup>

For hydrometer 151H:

- $L_1$  = 10.5 cm for a reading of 1.000  
 = 2.3 cm for a reading of 1.031

For hydrometer 152H:

- $L_1$  = 10.5 cm for a reading of 0 g/litre  
 = 2.3 cm for a reading of 50 g/litre

16.2 Calculate next the total mass passing the No. 200 sieve. Add together the fractional masses retained on all the sieves,

including the No. 10 sieve, and subtract this sum from the mass of the total sample (as calculated in 14.2).

16.3 Calculate next the total masses passing each of the other sieves, in a manner similar to that given in 12.2.

16.4 Calculate last the total percentages passing by dividing the total mass passing (as calculated in 16.3) by the total mass of sample (as calculated in 14.2), and multiply the result by 100.

## 17. Graph

17.1 When the hydrometer analysis is performed, a graph of the test results shall be made, plotting the diameters of the particles on a logarithmic scale as the abscissa and the percentages smaller than the corresponding diameters to an arithmetic scale as the ordinate. When the hydrometer analysis is not made on a portion of the soil, the preparation of the graph is optional, since values may be secured directly from tabulated data.

## 18. Report

18.1 The report shall include the following:

18.1.1 Maximum size of particles,

18.1.2 Percentage passing (or retained on) each sieve, which may be tabulated or presented by plotting on a graph (Note 16),

18.1.3 Description of sand and gravel particles:

18.1.3.1 Shape—rounded or angular,

18.1.3.2 Hardness—hard and durable, soft, or weathered and friable,

18.1.4 Specific gravity, if unusually high or low,

18.1.5 Any difficulty in dispersing the fraction passing the No. 10 (2.00-mm) sieve, indicating any change in type and amount of dispersing agent, and

18.1.6 The dispersion device used and the length of the dispersion period.

NOTE 16—This tabulation of graph represents the gradation of the sample tested. If particles larger than those contained in the sample were removed before testing, the report shall so state giving the amount and maximum size.

18.2 For materials tested for compliance with definite specifications, the fractions called for in such specifications shall be reported. The fractions smaller than the No. 10 sieve shall be read from the graph.

18.3 For materials for which compliance with definite specifications is not indicated and when the soil is composed almost entirely of particles passing the No. 4 (4.75-mm) sieve, the results read from the graph may be reported as follows:

- |  |     |   |
|--|-----|---|
| (1) Gravel, passing 3-in. and retained on No. 4 sieve              | ... | % |
| (2) Sand, passing No. 4 sieve and retained on No. 200 sieve        | ... | % |
| (a) Coarse sand, passing No. 4 sieve and retained on No. 10 sieve  | ... | % |
| (b) Medium sand, passing No. 10 sieve and retained on No. 40 sieve | ... | % |
| (c) Fine sand, passing No. 40 sieve and retained on No. 200 sieve  | ... | % |
| (3) Silt size, 0.074 to 0.005 mm                                   | ... | % |
| (4) Clay size, smaller than 0.005 mm                               | ... | % |
| Colloids, smaller than 0.001 mm                                    | ... | % |

18.4 For materials for which compliance with definite specifications is not indicated and when the soil contains material retained on the No. 4 sieve sufficient to require a sieve analysis on that portion, the results may be reported as follows (Note 17):

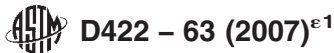

**TABLE 3 Values of K for Use in Equation for Computing Diameter of Particle in Hydrometer Analysis**

Temperature, ° C	Specific Gravity of Soil Particles								
	2.45	2.50	2.55	2.60	2.65	2.70	2.75	2.80	2.85
16	0.01530	0.01505	0.01481	0.01457	0.01435	0.01414	0.01394	0.01374	0.01356
17	0.01511	0.01486	0.01462	0.01439	0.01417	0.01396	0.01376	0.01356	0.01338
18	0.01492	0.01467	0.01443	0.01421	0.01399	0.01378	0.01359	0.01339	0.01321
19	0.01474	0.01449	0.01425	0.01403	0.01382	0.01361	0.01342	0.1323	0.01305
20	0.01456	0.01431	0.01408	0.01386	0.01365	0.01344	0.01325	0.01307	0.01289
21	0.01438	0.01414	0.01391	0.01369	0.01348	0.01328	0.01309	0.01291	0.01273
22	0.01421	0.01397	0.01374	0.01353	0.01332	0.01312	0.01294	0.01276	0.01258
23	0.01404	0.01381	0.01358	0.01337	0.01317	0.01297	0.01279	0.01261	0.01243
24	0.01388	0.01365	0.01342	0.01321	0.01301	0.01282	0.01264	0.01246	0.01229
25	0.01372	0.01349	0.01327	0.01306	0.01286	0.01267	0.01249	0.01232	0.01215
26	0.01357	0.01334	0.01312	0.01291	0.01272	0.01253	0.01235	0.01218	0.01201
27	0.01342	0.01319	0.01297	0.01277	0.01258	0.01239	0.01221	0.01204	0.01188
28	0.01327	0.01304	0.01283	0.01264	0.01244	0.01225	0.01208	0.01191	0.01175
29	0.01312	0.01290	0.01269	0.01249	0.01230	0.01212	0.01195	0.01178	0.01162
30	0.01298	0.01276	0.01256	0.01236	0.01217	0.01199	0.01182	0.01165	0.01149

SIEVE ANALYSIS		No. 200 (75-µm)	HYDROMETER ANALYSIS
Sieve Size	Percentage Passing		
3-in.	.....	0.074 mm	.....
2-in.	.....	0.005 mm	.....
1½-in.	.....	0.001 mm	.....
1-in.	.....		
¾-in.	.....		
⅝-in.	.....		
No. 4 (4.75-mm)	.....		
No. 10 (2.00-mm)	.....		
No. 40 (425-µm)	.....		

NOTE 17—No. 8 (2.36-mm) and No. 50 (300-µm) sieves may be substituted for No. 10 and No. 40 sieves.

**19. Keywords**

19.1 grain-size; hydrometer analysis; hygroscopic moisture; particle-size; sieve analysis

ASTM International takes no position respecting the validity of any patent rights asserted in connection with any item mentioned in this standard. Users of this standard are expressly advised that determination of the validity of any such patent rights, and the risk of infringement of such rights, are entirely their own responsibility.

This standard is subject to revision at any time by the responsible technical committee and must be reviewed every five years and if not revised, either reapproved or withdrawn. Your comments are invited either for revision of this standard or for additional standards and should be addressed to ASTM International Headquarters. Your comments will receive careful consideration at a meeting of the responsible technical committee, which you may attend. If you feel that your comments have not received a fair hearing you should make your views known to the ASTM Committee on Standards, at the address shown below.

This standard is copyrighted by ASTM International, 100 Barr Harbor Drive, PO Box C700, West Conshohocken, PA 19428-2959, United States. Individual reprints (single or multiple copies) of this standard may be obtained by contacting ASTM at the above address or at 610-832-9585 (phone), 610-832-9555 (fax), or service@astm.org (e-mail); or through the ASTM website (www.astm.org). Permission rights to photocopy the standard may also be secured from the ASTM website (www.astm.org/COPYRIGHT/).



**APPENDIX C**

**ASTM Standard D698  
Laboratory Compaction Characteristics of Soil  
Using Standard Effort (12 400 ft-lbf/ft<sup>3</sup> (600 kN-m/m<sup>3</sup>))**

Designation: D698 – 12<sup>ε</sup><sup>1</sup>

## Standard Test Methods for Laboratory Compaction Characteristics of Soil Using Standard Effort (12 400 ft-lbf/ft<sup>3</sup> (600 kN-m/m<sup>3</sup>))<sup>1</sup>

This standard is issued under the fixed designation D698; the number immediately following the designation indicates the year of original adoption or, in the case of revision, the year of last revision. A number in parentheses indicates the year of last reapproval. A superscript epsilon ( $\epsilon$ ) indicates an editorial change since the last revision or reapproval.

*This standard has been approved for use by agencies of the U.S. Department of Defense.*

<sup>ε</sup><sup>1</sup> NOTE—Editorial corrections made throughout in January 2014.

### 1. Scope\*

1.1 These test methods cover laboratory compaction methods used to determine the relationship between molding water content and dry unit weight of soils (compaction curve) compacted in a 4 or 6-in. (101.6 or 152.4-mm) diameter mold with a 5.50-lbf (24.5-N) rammer dropped from a height of 12.0 in. (305 mm) producing a compactive effort of 12 400 ft-lbf/ft<sup>3</sup> (600 kN-m/m<sup>3</sup>).

NOTE 1—The equipment and procedures are similar as those proposed by R. R. Proctor (*Engineering News Record*—September 7, 1933) with this one major exception: his rammer blows were applied as “12 inch firm strokes” instead of free fall, producing variable compactive effort depending on the operator, but probably in the range 15 000 to 25 000 ft-lbf/ft<sup>3</sup> (700 to 1200 kN-m/m<sup>3</sup>). The standard effort test (see 3.1.4) is sometimes referred to as the Proctor Test.

1.1.1 Soils and soil-aggregate mixtures are to be regarded as natural occurring fine- or coarse-grained soils, or composites or mixtures of natural soils, or mixtures of natural and processed soils or aggregates such as gravel or crushed rock. Hereafter referred to as either soil or material.

1.2 These test methods apply only to soils (materials) that have 30 % or less by mass of particles retained on the  $\frac{3}{4}$ -in. (19.0-mm) sieve and have not been previously compacted in the laboratory; that is, do not reuse compacted soil.

1.2.1 For relationships between unit weights and molding water contents of soils with 30 % or less by mass of material retained on the  $\frac{3}{4}$ -in. (19.0-mm) sieve to unit weights and molding water contents of the fraction passing  $\frac{3}{4}$ -in. (19.0-mm) sieve, see Practice D4718.

1.3 Three alternative methods are provided. The method used shall be as indicated in the specification for the material being tested. If no method is specified, the choice should be based on the material gradation.

<sup>1</sup> These Test Methods are under the jurisdiction of ASTM Committee D18 on Soil and Rock and are the direct responsibility of Subcommittee D18.03 on Texture, Plasticity and Density Characteristics of Soils.

Current edition approved May 1, 2012. Published June 2012. Originally approved in 1942. Last previous edition approved in 2000 as D698 – 07<sup>ε</sup><sup>1</sup>. DOI: 10.1520/D0698-12E01.

#### 1.3.1 Method A:

1.3.1.1 *Mold*—4-in. (101.6-mm) diameter.

1.3.1.2 *Material*—Passing No. 4 (4.75-mm) sieve.

1.3.1.3 *Layers*—Three.

1.3.1.4 *Blows per Layer*—25.

1.3.1.5 *Usage*—May be used if 25 % or less (see 1.4) by mass of the material is retained on the No. 4 (4.75-mm) sieve.

1.3.1.6 *Other Usage*—If this gradation requirement cannot be met, then Method C may be used.

#### 1.3.2 Method B:

1.3.2.1 *Mold*—4-in. (101.6-mm) diameter.

1.3.2.2 *Material*—Passing  $\frac{3}{8}$ -in. (9.5-mm) sieve.

1.3.2.3 *Layers*—Three.

1.3.2.4 *Blows per Layer*—25.

1.3.2.5 *Usage*—May be used if 25 % or less (see 1.4) by mass of the material is retained on the  $\frac{3}{8}$ -in. (9.5-mm) sieve.

1.3.2.6 *Other Usage*—If this gradation requirement cannot be met, then Method C may be used.

#### 1.3.3 Method C:

1.3.3.1 *Mold*—6-in. (152.4-mm) diameter.

1.3.3.2 *Material*—Passing  $\frac{3}{4}$ -in. (19.0-mm) sieve.

1.3.3.3 *Layers*—Three.

1.3.3.4 *Blows per Layer*—56.

1.3.3.5 *Usage*—May be used if 30 % or less (see 1.4) by mass of the material is retained on the  $\frac{3}{4}$ -in. (19.0-mm) sieve.

1.3.4 The 6-in. (152.4-mm) diameter mold shall not be used with Method A or B.

NOTE 2—Results have been found to vary slightly when a material is tested at the same compactive effort in different size molds, with the smaller mold size typically yielding larger values of density/unit weight (1, pp. 21+).<sup>2</sup>

1.4 If the test specimen contains more than 5 % by mass of oversize fraction (coarse fraction) and the material will not be included in the test, corrections must be made to the unit mass and molding water content of the specimen or to the appropriate field-in-place density test specimen using Practice D4718.

<sup>2</sup> The boldface numbers in parentheses refer to the list of references at the end of this standard.

\*A Summary of Changes section appears at the end of this standard





1.5 This test method will generally produce a well-defined maximum dry unit weight for non-free draining soils. If this test method is used for free-draining soils the maximum unit weight may not be well defined, and can be less than obtained using Test Methods [D4253](#).

1.6 All observed and calculated values shall conform to the guidelines for significant digits and rounding established in Practice [D6026](#), unless superseded by this standard.

1.6.1 For purposes of comparing measured or calculated value(s) with specified limits, the measured or calculated value(s) shall be rounded to the nearest decimal or significant digits in the specified limits.

1.6.2 The procedures used to specify how data are collected/recorded or calculated, in this standard are regarded as the industry standard. In addition, they are representative of the significant digits that generally should be retained. The procedures used do not consider material variation, purpose for obtaining the data, special purpose studies, or any considerations for the user's objectives; and it is common practice to increase or reduce significant digits of reported data to be commensurate with these considerations. It is beyond the scope of this standard to consider significant digits used in analytical methods for engineering design.

1.7 The values in inch-pound units are to be regarded as the standard. The values stated in SI units are provided for information only, except for units of mass. The units for mass are given in SI units only, g or kg.

1.7.1 It is common practice in the engineering profession to concurrently use pounds to represent both a unit of mass (lbm) and a force (lbf). This implicitly combines two separate systems of units; that is, the absolute system and the gravitational system. It is scientifically undesirable to combine the use of two separate sets of inch-pound units within a single standard. This standard has been written using the gravitational system of units when dealing with the inch-pound system. In this system, the pound (lbf) represents a unit of force (weight). However, the use of balances or scales recording pounds of mass (lbm) or the recording of density in lbm/ft<sup>3</sup> shall not be regarded as a nonconformance with this standard.

1.8 *This standard does not purport to address all of the safety concerns, if any, associated with its use. It is the responsibility of the user of this standard to establish appropriate safety and health practices and determine the applicability of regulatory limitations prior to use.*

## 2. Referenced Documents

### 2.1 ASTM Standards:<sup>3</sup>

- [C127](#) Test Method for Density, Relative Density (Specific Gravity), and Absorption of Coarse Aggregate
- [C136](#) Test Method for Sieve Analysis of Fine and Coarse Aggregates
- [D653](#) Terminology Relating to Soil, Rock, and Contained Fluids

<sup>3</sup> For referenced ASTM standards, visit the ASTM website, [www.astm.org](http://www.astm.org), or contact ASTM Customer Service at [service@astm.org](mailto:service@astm.org). For *Annual Book of ASTM Standards* volume information, refer to the standard's Document Summary page on the ASTM website.

- [D854](#) Test Methods for Specific Gravity of Soil Solids by Water Pycnometer
- [D2168](#) Practices for Calibration of Laboratory Mechanical-Rammer Soil Compactors
- [D2216](#) Test Methods for Laboratory Determination of Water (Moisture) Content of Soil and Rock by Mass
- [D2487](#) Practice for Classification of Soils for Engineering Purposes (Unified Soil Classification System)
- [D2488](#) Practice for Description and Identification of Soils (Visual-Manual Procedure)
- [D3740](#) Practice for Minimum Requirements for Agencies Engaged in Testing and/or Inspection of Soil and Rock as Used in Engineering Design and Construction
- [D4253](#) Test Methods for Maximum Index Density and Unit Weight of Soils Using a Vibratory Table
- [D4718](#) Practice for Correction of Unit Weight and Water Content for Soils Containing Oversize Particles
- [D4753](#) Guide for Evaluating, Selecting, and Specifying Balances and Standard Masses for Use in Soil, Rock, and Construction Materials Testing
- [D4914](#) Test Methods for Density and Unit Weight of Soil and Rock in Place by the Sand Replacement Method in a Test Pit
- [D5030](#) Test Method for Density of Soil and Rock in Place by the Water Replacement Method in a Test Pit
- [D6026](#) Practice for Using Significant Digits in Geotechnical Data
- [D6913](#) Test Methods for Particle-Size Distribution (Gradation) of Soils Using Sieve Analysis
- [E11](#) Specification for Woven Wire Test Sieve Cloth and Test Sieves
- [E177](#) Practice for Use of the Terms Precision and Bias in ASTM Test Methods
- [E691](#) Practice for Conducting an Interlaboratory Study to Determine the Precision of a Test Method
- IEEE/ASTM SI 10 Standard for Use of the International System of Units (SI): the Modern Metric System

## 3. Terminology

### 3.1 Definitions:

- 3.1.1 See Terminology [D653](#) for general definitions.
- 3.1.2 *molding water content, n*—the adjusted water content of a soil (material) that will be compacted/reconstituted.
- 3.1.3 *standard effort*—in compaction testing, the term for the 12 400 ft-lbf/ft<sup>3</sup> (600 kN-m/m<sup>3</sup>) compactive effort applied by the equipment and methods of this test.
- 3.1.4 *standard maximum dry unit weight,  $\gamma_{d,max}$  in lb/ft<sup>3</sup> (kN/m<sup>3</sup>)*—in compaction testing, the maximum value defined by the compaction curve for a compaction test using standard effort.
- 3.1.5 *standard optimum water content,  $w_{opt}$  in %*—in compaction testing, the molding water content at which a soil can be compacted to the maximum dry unit weight using standard compactive effort.

### 3.2 Definitions of Terms Specific to This Standard:

- 3.2.1 *oversize fraction (coarse fraction),  $P_C$  in %*—the portion of total specimen not used in performing the compaction



test; it may be the portion of total specimen retained on the No. 4 (4.75-mm) sieve in Method A,  $\frac{3}{8}$ -in. (9.5-mm) sieve in Method B, or  $\frac{3}{4}$ -in. (19.0-mm) sieve in Method C.

3.2.2 *test fraction (finer fraction),  $P_F$  in %*—the portion of the total specimen used in performing the compaction test; it is the fraction passing the No. 4 (4.75-mm) sieve in Method A, passing the  $\frac{3}{8}$ -in. (9.5-mm) sieve in Method B, or passing the  $\frac{3}{4}$ -in. (19.0-mm) sieve in Method C.

#### 4. Summary of Test Method

4.1 A soil at a selected molding water content is placed in three layers into a mold of given dimensions, with each layer compacted by 25 or 56 blows of a 5.50-lbf (24.47-N) rammer dropped from a distance of 12.00 in. (304.8 mm), subjecting the soil to a total compactive effort of about 12 400 ft-lbf/ft<sup>3</sup> (600 kN-m/m<sup>3</sup>). The resulting dry unit weight is determined. The procedure is repeated for a sufficient number of molding water contents to establish a relationship between the dry unit weight and the molding water content for the soil. This data, when plotted, represents a curvilinear relationship known as the compaction curve. The values of optimum water content and standard maximum dry unit weight are determined from the compaction curve.

#### 5. Significance and Use

5.1 Soil placed as engineering fill (embankments, foundation pads, road bases) is compacted to a dense state to obtain satisfactory engineering properties such as, shear strength, compressibility, or permeability. In addition, foundation soils are often compacted to improve their engineering properties. Laboratory compaction tests provide the basis for determining the percent compaction and molding water content needed to achieve the required engineering properties, and for controlling construction to assure that the required compaction and water contents are achieved.

5.2 During design of an engineered fill, shear, consolidation, permeability, or other tests require preparation of test specimens by compacting at some molding water content to some unit weight. It is common practice to first determine the optimum water content ( $w_{opt}$ ) and maximum dry unit weight ( $\gamma_{d,max}$ ) by means of a compaction test. Test specimens are compacted at a selected molding water content ( $w$ ), either wet or dry of optimum ( $w_{opt}$ ) or at optimum ( $w_{opt}$ ), and at a selected dry unit weight related to a percentage of maximum dry unit weight ( $\gamma_{d,max}$ ). The selection of molding water content ( $w$ ), either wet or dry of optimum ( $w_{opt}$ ) or at optimum ( $w_{opt}$ ) and the dry unit weight ( $\gamma_{d,max}$ ) may be based on past experience, or a range of values may be investigated to determine the necessary percent of compaction.

5.3 Experience indicates that the methods outlined in 5.2 or the construction control aspects discussed in 5.1 are extremely difficult to implement or yield erroneous results when dealing with certain soils. 5.3.1 – 5.3.3 describe typical problem soils, the problems encountered when dealing with such soils and possible solutions for these problems.

5.3.1 *Oversize Fraction*—Soils containing more than 30 % oversize fraction (material retained on the  $\frac{3}{4}$ -in. (19-mm) sieve) are a problem. For such soils, there is no ASTM test

method to control their compaction and very few laboratories are equipped to determine the laboratory maximum unit weight (density) of such soils (USDI Bureau of Reclamation, Denver, CO and U.S. Army Corps of Engineers, Vicksburg, MS). Although Test Methods D4914 and D5030 determine the “field” dry unit weight of such soils, they are difficult and expensive to perform.

5.3.1.1 One method to design and control the compaction of such soils is to use a test fill to determine the required degree of compaction and the method to obtain that compaction, followed by use of a method specification to control the compaction. Components of a method specification typically contain the type and size of compaction equipment to be used, the lift thickness, acceptable range in molding water content, and the number of passes.

NOTE 3—Success in executing the compaction control of an earthwork project, especially when a method specification is used, is highly dependent upon the quality and experience of the contractor and inspector.

5.3.1.2 Another method is to apply the use of density correction factors developed by the USDI Bureau of Reclamation (2, 3) and U.S. Corps of Engineers (4). These correction factors may be applied for soils containing up to about 50 to 70 % oversize fraction. Each agency uses a different term for these density correction factors. The USDI Bureau of Reclamation uses  $D$  ratio (or  $D$ -VALUE), while the U.S. Corps of Engineers uses Density Interference Coefficient ( $I_c$ ).

5.3.1.3 The use of the replacement technique (Test Method D698–78, Method D), in which the oversize fraction is replaced with a finer fraction, is inappropriate to determine the maximum dry unit weight,  $\gamma_{d,max}$ , of soils containing oversize fractions (4).

5.3.2 *Degradation*—Soils containing particles that degrade during compaction are a problem, especially when more degradation occurs during laboratory compaction than field compaction, as is typical. Degradation typically occurs during the compaction of a granular-residual soil or aggregate. When degradation occurs, the maximum dry-unit weight increases (1, p. 73) so that the laboratory maximum value is not representative of field conditions. Often, in these cases, the maximum dry unit weight is impossible to achieve in the field.

5.3.2.1 Again, for soils subject to degradation, the use of test fills and method specifications may help. Use of replacement techniques is not correct.

5.3.3 *Gap Graded*—Gap-graded soils (soils containing many large particles with limited small particles) are a problem because the compacted soil will have larger voids than usual. To handle these large voids, standard test methods (laboratory or field) typically have to be modified using engineering judgement.

NOTE 4—The quality of the result produced by this standard is dependent on the competence of the personnel performing it, and the suitability of the equipment and facilities used. Agencies that meet the criteria of Practice D3740 are generally considered capable of competent and objective testing/sampling/inspection, and the like. Users of this standard are cautioned that compliance with Practice D3740 does not in itself assure reliable results. Reliable results depend on many factors; Practice D3740 provides a means of evaluating some of those factors.

6. Apparatus

6.1 *Mold Assembly*—The molds shall be cylindrical in shape, made of rigid metal and be within the capacity and dimensions indicated in 6.1.1 or 6.1.2 and Figs. 1 and 2. See also Table 1. The walls of the mold may be solid, split, or tapered. The “split” type may consist of two half-round sections, or a section of pipe split along one element, which can be securely locked together to form a cylinder meeting the requirements of this section. The “tapered” type shall have an internal diameter taper that is uniform and not more than 0.200 in./ft (16.7 mm/m) of mold height. Each mold shall have a base plate and an extension collar assembly, both made of rigid metal and constructed so they can be securely attached and easily detached from the mold. The extension collar assembly shall have a height extending above the top of the mold of at least 2.0 in. (51 mm) which may include an upper section that flares out to form a funnel, provided there is at least a 0.75 in. (19 mm) straight cylindrical section beneath it. The extension collar shall align with the inside of the mold. The bottom of the base plate and bottom of the centrally recessed area that accepts the cylindrical mold shall be planar within  $\pm 0.005$  in. ( $\pm 0.1$  mm).

6.1.1 *Mold, 4 in.*—A mold having a  $4.000 \pm 0.016$ -in. ( $101.6 \pm 0.4$ -mm) average inside diameter, a height of  $4.584 \pm 0.018$  in. ( $116.4 \pm 0.5$  mm) and a volume of  $0.0333 \pm 0.0005$  ft<sup>3</sup> ( $943.0 \pm 14$  cm<sup>3</sup>). A mold assembly having the minimum required features is shown in Fig. 1.

6.1.2 *Mold, 6 in.*—A mold having a  $6.000 \pm 0.026$ -in. ( $152.4 \pm 0.7$ -mm) average inside diameter, a height of  $4.584 \pm 0.018$  in. ( $116.4 \pm 0.5$  mm), and a volume of  $0.0750 \pm 0.0009$  ft<sup>3</sup> ( $2124 \pm 25$  cm<sup>3</sup>). A mold assembly having the minimum required features is shown in Fig. 2.

6.2 *Rammer*—A rammer, either manually operated as described further in 6.2.1 or mechanically operated as described in 6.2.2. The rammer shall fall freely through a distance of  $12.00 \pm 0.05$  in. ( $304.8 \pm 1$  mm) from the surface of the specimen. The weight of the rammer shall be  $5.50 \pm 0.02$  lbf ( $24.47 \pm 0.09$  N, or mass of  $2.495 \pm 0.009$  kg), except that the weight of the mechanical rammers may be adjusted as described in Practices D2168; see Note 5. The striking face of the rammer shall be planar and circular, except as noted in 6.2.2.1, with a diameter when new of  $2.000 \pm 0.005$  in. ( $50.80 \pm 0.13$  mm). The rammer shall be replaced if the striking face

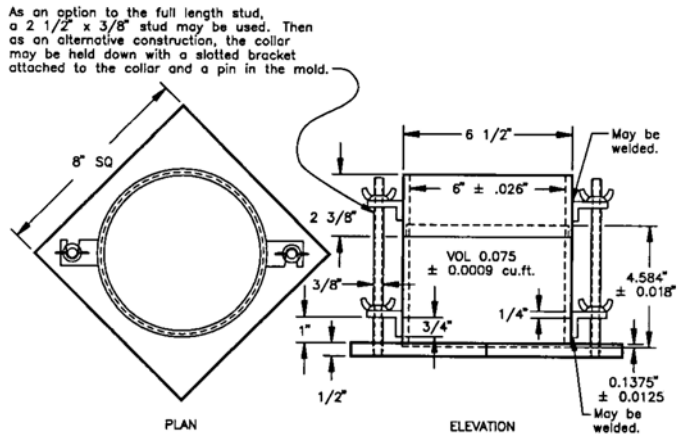

FIG. 2 6.0-in. Cylindrical Mold

TABLE 1 Metric Equivalents for Figs. 1 and 2

in.	mm
0.016	0.41
0.026	0.66
0.032	0.81
0.028	0.71
1/2	12.70
2 1/2	63.50
2 5/8	66.70
4	101.60
4 1/2	114.30
4.584	116.43
4 3/4	120.60
6	152.40
6 1/2	165.10
6 5/8	168.30
6 3/4	171.40
8 1/4	209.60
ft <sup>3</sup>	cm <sup>3</sup>
1/50 (0.0333)	943
0.0005	14
(0.0750)	2,124
0.0011	31

becomes worn or bellied to the extent that the diameter exceeds  $2.000 \pm 0.01$  in. ( $50.80 \pm 0.25$  mm).

NOTE 5—It is a common and acceptable practice to determine the weight of the rammer using either a kilogram or pound balance and assume 1 lbf is equivalent to 0.4536 kg, 1 lbf is equivalent to 1 lbm, or 1 N is equivalent to 0.2248 lbf or 0.1020 kg.

6.2.1 *Manual Rammer*—The rammer shall be equipped with a guide sleeve that has sufficient clearance that the free fall of the rammer shaft and head is not restricted. The guide sleeve shall have at least four vent holes at each end (eight holes total) located with centers  $3/4 \pm 1/16$  in. ( $19 \pm 2$  mm) from each end and spaced 90 degrees apart. The minimum diameter of the vent holes shall be  $3/8$  in. (9.5 mm). Additional holes or slots may be incorporated in the guide sleeve.

6.2.2 *Mechanical Rammer-Circular Face*—The rammer shall operate mechanically in such a manner as to provide uniform and complete coverage of the specimen surface. There shall be  $0.10 \pm 0.03$ -in. ( $2.5 \pm 0.8$ -mm) clearance between the rammer and the inside surface of the mold at its smallest diameter. The mechanical rammer shall meet the standardization/calibration requirements of Practices D2168.

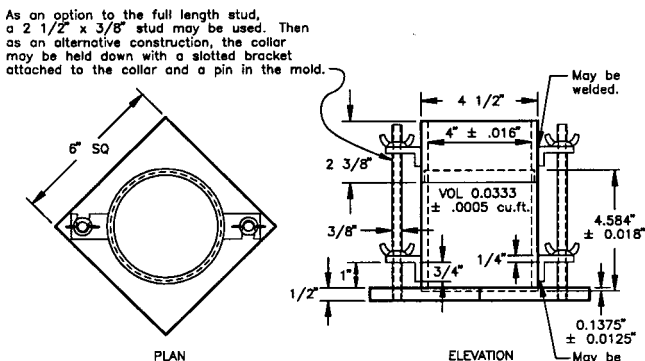

FIG. 1 4.0-in. Cylindrical Mold



The mechanical rammer shall be equipped with a positive mechanical means to support the rammer when not in operation.

6.2.2.1 *Mechanical Rammer-Sector Face*—The sector face can be used with the 6-in. (152.4-mm) mold, as an alternative to the circular face mechanical rammer described in 6.2.2. The striking face shall have the shape of a sector of a circle of radius equal to  $2.90 \pm 0.02$  in. ( $73.7 \pm 0.5$  mm) and an area about the same as the circular face, see 6.2. The rammer shall operate in such a manner that the vertex of the sector is positioned at the center of the specimen and follow the compaction pattern given in Fig. 3b.

6.3 *Sample Extruder (optional)*—A jack, with frame or other device adapted for the purpose of extruding compacted specimens from the mold.

6.4 *Balance*—A Class GP5 balance meeting the requirements of Guide D4753 for a balance of 1-g readability. If the water content of the compacted specimens is determined using a representative portion of the specimen, rather than the whole specimen, and if the representative portion is less than 1000 g, a Class GP2 balance having a 0.1-g readability is needed in order to comply with Test Methods D2216 requirements for determining water content to 0.1 %.

NOTE 6—Use of a balance having an equivalent capacity and a readability of 0.002 lbm as an alternative to a class GP5 balance should not be regarded as nonconformance to this standard.

6.5 *Drying Oven*—Thermostatically controlled oven, capable of maintaining a uniform temperature of  $230 \pm 9^\circ\text{F}$  ( $110 \pm 5^\circ\text{C}$ ) throughout the drying chamber. These requirements typically require the use of a forced-draft type oven. Preferably the oven should be vented outside the building.

6.6 *Straightedge*—A stiff metal straightedge of any convenient length but not less than 10 in. (250 mm). The total length of the straightedge shall be machined straight to a tolerance of  $\pm 0.005$  in. ( $\pm 0.1$  mm). The scraping edge shall be beveled if it is thicker than  $\frac{1}{8}$  in. (3 mm).

6.7 *Sieves*— $\frac{3}{4}$  in. (19.0 mm),  $\frac{3}{8}$  in. (9.5 mm), and No. 4 (4.75 mm), conforming to the requirements of Specification E11.

6.8 *Mixing Tools*—Miscellaneous tools such as mixing pan, spoon, trowel, spatula, spraying device (to add water evenly), and (preferably, but optional) suitable mechanical device for thoroughly mixing the subspecimen of soil with increments of water.

## 7. Standardization/Calibration

7.1 Perform standardizations before initial use, after repairs or other occurrences that might affect the test results, at intervals not exceeding 1,000 test specimens, or annually, whichever occurs first, for the following apparatus:

7.1.1 *Balance*—Evaluate in accordance with Guide D4753.

7.1.2 *Molds*—Determine the volume as described in Annex A1.

7.1.3 *Manual Rammer*—Verify the free fall distance, rammer weight, and rammer face are in accordance with 6.2. Verify the guide sleeve requirements are in accordance with 6.2.1.

7.1.4 *Mechanical Rammer*—Verify and adjust if necessary that the mechanical rammer is in accordance with Practices D2168. In addition, the clearance between the rammer and the inside surface of the mold shall be verified in accordance with 6.2.2.

## 8. Test Specimen

8.1 The minimum specimen (test fraction) mass for Methods A and B is about 16 kg, and for Method C is about 29 kg of dry soil. Therefore, the field sample should have a moist mass of at least 23 kg and 45 kg, respectively. Greater masses would be required if the oversize fraction is large (see 10.2 or 10.3) or an additional molding water content is taken during compaction of each point (see 10.4.2.1).

8.2 If gradation data is not available, estimate the percentage of material (by mass) retained on the No. 4 (4.75-mm),  $\frac{3}{8}$ -in. (9.5-mm), or  $\frac{3}{4}$ -in. (19.0-mm) sieve as appropriate for selecting Method A, B, or C, respectively. If it appears the percentage retained of interest is close to the allowable value for a given Method (A, B, or C), then either:

8.2.1 Select a Method that allows a higher percentage retained (B or C).

8.2.2 Using the Method of interest, process the specimen in accordance with 10.2 or 10.3, this determines the percentage retained for that method. If acceptable, proceed, if not go to the next Method (B or C).

8.2.3 Determine percentage retained values by using a representative portion from the total sample, and performing a simplified or complete gradation analysis using the sieve(s) of interest and Test Methods D6913 or C136. It is only necessary to calculate the retained percentage(s) for the sieve or sieves for which information is desired.

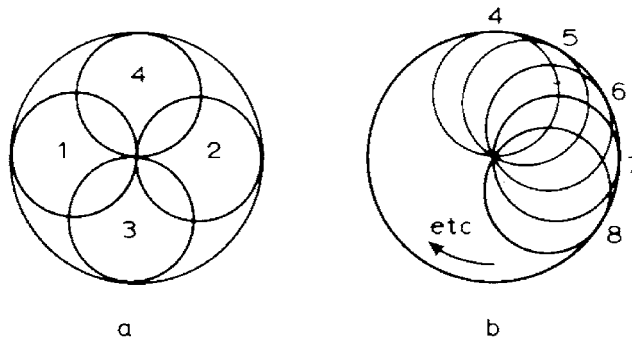

FIG. 3 Rammer Pattern for Compaction in 4 in. (101.6 mm) Mold



## 9. Preparation of Apparatus

9.1 Select the proper compaction mold(s), collar, and base plate in accordance with the Method (A, B, or C) being used. Check that its volume is known and determined with or without base plate, free of nicks or dents, and will fit together properly.

NOTE 7—Mass requirements are given in 10.4.

9.2 Check that the manual or mechanical rammer assembly is in good working condition and that parts are not loose or worn. Make any necessary adjustments or repairs. If adjustments or repairs are made, the rammer must be re-standardized.

## 10. Procedure

### 10.1 Soils:

10.1.1 Do not reuse soil that has been previously compacted in the laboratory. The reuse of previously compacted soil yields a significantly greater maximum dry unit weight (1, p. 31).

10.1.2 When using this test method for soils containing hydrated halloysite, or in which past experience indicates that results will be altered by air-drying, use the moist preparation method (see 10.2). In referee testing, each laboratory has to use the same method of preparation, either moist (preferred) or air-dried.

10.1.3 Prepare the soil specimens for testing in accordance with 10.2 (preferred) or with 10.3.

10.2 *Moist Preparation Method (preferred)*—Without previously drying the sample/specimen, process it over a No. 4 (4.75-mm),  $\frac{3}{8}$ -in. (9.5-mm), or  $\frac{3}{4}$ -in. (19.0-mm) sieve, depending on the Method (A, B, or C) being used or required as covered in 8.2. For additional processing details, see Test Methods D6913. Determine and record the mass of both the retained and passing portions (oversize fraction and test fraction, respectively) to the nearest g. Oven dry the oversize fraction and determine and record its dry mass to the nearest g. If it appears more than 0.5 % of the total dry mass of the specimen is adhering to the oversize fraction, wash that fraction. Then determine and record its oven dry mass to the nearest g. Determine and record the water content of the processed soil (test fraction). Using that water content, determine and record the oven dry mass of the test fraction to the nearest g. Based on these oven dry masses, the percent oversize fraction,  $P_C$ , and test fraction,  $P_F$ , shall be determined and recorded, unless a gradation analysis has already been performed, see Section 11 on Calculations.

10.2.1 From the test fraction, select and prepare at least four (preferably five) subspecimens having molding water contents such that they bracket the estimated optimum water content. A subspecimen having a molding water content close to optimum should be prepared first by trial additions or removals of water and mixing (see Note 8). Select molding water contents for the rest of the subspecimens to provide at least two subspecimens wet and two subspecimens dry of optimum, and molding water contents varying by about 2 %. At least two molding water contents are necessary on the wet and dry side of optimum to define the dry-unit-weight compaction curve (see 10.5). Some soils with very high optimum water content or a relatively flat compaction curve may require larger molding water content

increments to obtain a well-defined maximum dry unit weight. Molding water content increments should not exceed about 4 %.

NOTE 8—With practice it is usually possible to visually judge a point near optimum water content. Typically, cohesive soils at the optimum water content can be squeezed into a lump that sticks together when hand pressure is released, but will break cleanly into two sections when “bent.” They tend to crumble at molding water contents dry of optimum; while, they tend to stick together in a sticky cohesive mass wet of optimum. The optimum water content is typically slightly less than the plastic limit. While for cohesionless soils, the optimum water content is typically close to zero or at the point where bleeding occurs.

10.2.2 Thoroughly mix the test fraction, then using a scoop select representative soil for each subspecimen (compaction point). Select about 2.3 kg when using Method A or B, or about 5.9 kg for Method C. Test Methods D6913 section on Specimen and Annex A2 gives additional details on obtaining representative soil using this procedure and why it is the preferred method. To obtain the subspecimen’s molding water contents selected in 10.2.1, add or remove the required amounts of water as follows. To add water, spray it into the soil during mixing; to remove water, allow the soil to dry in air at ambient temperature or in a drying apparatus such that the temperature of the sample does not exceed 140°F (60°C). Mix the soil frequently during drying to facilitate an even water content distribution. Thoroughly mix each subspecimen to facilitate even distribution of water throughout and then place in a separate covered container to stand (cure) in accordance with Table 2 prior to compaction. For selecting a standing time, the soil may be classified using Practice D2487, Practice D2488, or data on other samples from the same material source. For referee testing, classification shall be by Practice D2487.

10.3 *Dry Preparation Method*—If the sample/specimen is too damp to be friable, reduce the water content by air drying until the material is friable. Drying may be in air or by the use of drying apparatus such that the temperature of the sample does not exceed 140°F (60°C). Thoroughly break up the aggregations in such a manner as to avoid breaking individual particles. Process the material over the appropriate sieve: No. 4 (4.75-mm),  $\frac{3}{8}$ -in. (9.5-mm), or  $\frac{3}{4}$ -in. (19.0-mm). When preparing the material by passing over the  $\frac{3}{4}$ -in. sieve for compaction in the 6-in. mold, break up aggregations sufficiently to at least pass the  $\frac{3}{8}$ -in. sieve in order to facilitate the distribution of water throughout the soil in later mixing. Determine and record the water content of the test fraction and all masses covered in 10.2, as applicable to determine the percent oversize fraction,  $P_C$ , and test fraction,  $P_F$ .

10.3.1 From the test fraction, select and prepare at least four (preferably five) subspecimens in accordance with 10.2.1 and 10.2.2, except for the following: Use either a mechanical splitting or quartering process to obtain the subspecimens. As

**TABLE 2 Required Standing Times of Moisturized Specimens**

Classification	Minimum Standing Time, h
GW, GP, SW, SP	No Requirement
GM, SM	3
All other soils	16

stated in Test Methods **D6913**, both of these processes will yield non-uniform subspecimens compared to the moist procedure. Typically, only the addition of water to each subspecimen will be required.

10.4 *Compaction*—After standing (curing), if required, each subspecimen (compaction point) shall be compacted as follows:

10.4.1 Determine and record the mass of the mold or mold and base plate, see **10.4.7**.

10.4.2 Assemble and secure the mold and collar to the base plate. Check the alignment of the inner wall of the mold and mold extension collar. Adjust if necessary. The mold shall rest, without wobbling/rocking on a uniform rigid foundation, such as provided by a cylinder or cube of concrete with a weight or mass of not less than 200-lbf or 91-kg, respectively. Secure the base plate to the rigid foundation. The method of attachment to the rigid foundation shall allow easy removal of the assembled mold, collar and base plate after compaction is completed.

10.4.2.1 During compaction, it is advantageous but not required to determine the water content of each subspecimen. This provides a check on the molding water content determined for each compaction point and the magnitude of bleeding, see **10.4.9**. However, more soil will have to be selected for each subspecimen than stated in **10.2.2**.

10.4.3 Compact the soil in three layers. After compaction, each layer should be approximately equal in thickness and extend into the collar. Prior to compaction, place the loose soil into the mold and spread into a layer of uniform thickness. Lightly tamp the soil prior to compaction until it is not in a fluffy or loose state, using either the manual rammer or a  $2 \pm$ -in. ( $50 \pm$ -mm) diameter cylinder. Following compaction of each of the first two layers, any soil that has not been compacted; such as adjacent to the mold walls or extends

above the compacted surface (up the mold walls) shall be trimmed. The trimmed soil shall be discarded. A knife or other suitable device may be used. The total amount of soil used shall be such that the third compacted layer slightly extends into the collar, but does not extend more than approximately  $\frac{1}{4}$ -in. (6-mm) above the top of the mold. If the third layer does extend above this limit, then the compaction point shall be discarded. In addition, the compaction point shall be discarded when the last blow on the rammer for the third layer results in the bottom of the rammer extending below the top of the compaction mold; unless the soil is pliable enough, that this surface can easily be forced above the top of the compaction mold during trimming (see **Note 9**).

10.4.4 Compact each layer with 25 blows for the 4-in. (101.6-mm) mold or with 56 blows for the 6-in. (152.4-mm) mold. The manual rammer shall be used for referee testing.

10.4.5 In operating the manual rammer, take care to avoid lifting the guide sleeve during the rammer upstroke. Hold the guide sleeve steady and within  $5^\circ$  of vertical. Apply the blows at a uniform rate of about 25 blows/min and in such a manner as to provide complete, uniform coverage of the specimen surface. When using a 4-in. (101.6-mm) mold and manual rammer, follow the blow pattern given in **Fig. 3a** and **Fig. 3b**; while for a mechanical rammer, follow the pattern in **Fig. 3b**. When using a 6-in. (152.4-mm) mold and manual rammer, follow the blow pattern given in **Fig. 4** up to the 9th blow, then systematically around the mold (**Fig. 3b**) and in the middle. When using a 6-in. (152.4-mm) mold and a mechanical rammer equipped with a sector face, the mechanical rammer shall be designed to follow the compaction pattern given in **Fig. 3b**. When using a 6-in. (152.4-mm) mold and a mechanical rammer equipped with a circular face, the mechanical rammer shall be designed to distribute the blows uniformly over the

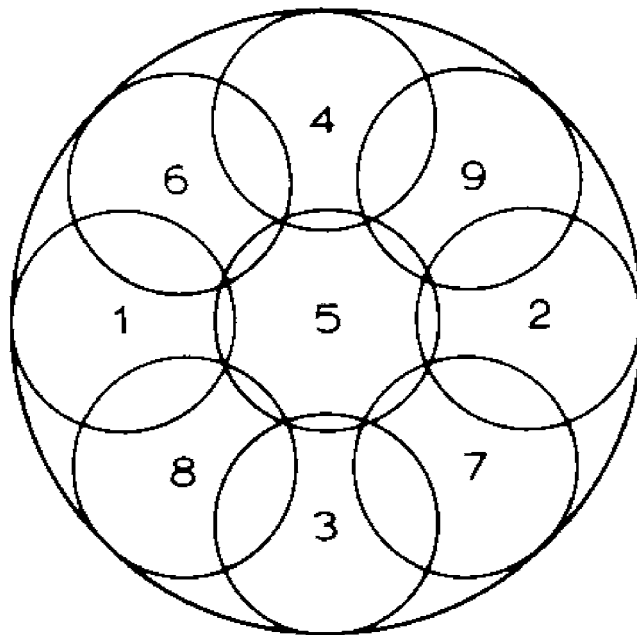

**FIG. 4 Rammer Pattern for Compaction in 6 in. (152.4 mm) Mold**





surface of the specimen. If the surface of the compacted soil becomes highly uneven (see [Note 9](#)), then adjust the pattern to follow the logic given in [Fig. 3a](#) or [Fig. 4](#). This will most likely void the use of a mechanical rammer for such compaction points.

**NOTE 9**—When compacting specimens wetter than optimum water content, uneven compacted surfaces can occur and operator judgement is required as to the average height of the specimen and rammer pattern during compaction.

10.4.6 Following compaction of the last layer, remove the collar and base plate (except as noted in [10.4.7](#)) from the mold. A knife may be used to trim the soil adjacent to the collar to loosen the soil from the collar before removal to avoid disrupting the soil below the top of the mold. In addition, to prevent/reduce soil sticking to the collar or base plate, rotate them before removal.

10.4.7 Carefully trim the compacted specimen even with the top of the mold by means of the straightedge scraped across the top of the mold to form a plane surface even with the top of the mold. Initial trimming of the specimen above the top of the mold with a knife may prevent the soil from tearing below the top of the mold. Fill any holes in the top surface with unused or trimmed soil from the specimen, press in with the fingers, and again scrape the straightedge across the top of the mold. If gravel size particles are encountered, trim around them or remove them, whichever is the easiest and reduces the disturbance of the compacted soil. The estimated volume of particles above the surface of the compacted soil and holes in that surface shall be equal, fill in remaining holes as mentioned above. Repeat the appropriate preceding operations on the bottom of the specimen when the mold volume was determined without the base plate. For very wet or dry soils, soil or water may be lost if the base plate is removed. For these situations, leave the base plate attached to the mold. When the base plate is left attached, the volume of the mold must be calibrated with the base plate attached to the mold rather than a plastic or glass plate as noted in [Annex A1, A1.4](#).

10.4.8 Determine and record the mass of the specimen and mold to the nearest g. When the base plate is left attached, determine and record the mass of the specimen, mold and base plate to the nearest g.

10.4.9 Remove the material from the mold. Obtain a specimen for molding water content by using either the whole specimen (preferred method) or a representative portion. When the entire specimen is used, break it up to facilitate drying. Otherwise, obtain a representative portion of the three layers, removing enough material from the specimen to report the water content to 0.1 %. The mass of the representative portion of soil shall conform to the requirements of Table 1, Method B, of Test Methods [D2216](#). Determine the molding water content in accordance with Test Methods [D2216](#).

10.5 Following compaction of the last specimen, compare the wet unit weights to ensure that a desired pattern of obtaining data on each side of the optimum water content will be attained for the dry-unit-weight compaction curve. Plotting the wet unit weight and molding water content of each compacted specimen can be an aid in making the above evaluation. If the desired pattern is not obtained, additional

compacted specimens will be required. Generally, for experienced plotters of compaction curves, one compaction point wet of the optimum water content is adequate to define the maximum wet unit weight, see [11.2](#).

## 11. Calculations and Plotting (Compaction Curve)

11.1 *Fraction Percentages*—If gradation data from Test Methods [D6913](#) is not available, calculate the dry mass of the test fraction, percentage of oversize fraction and test fraction as covered below and using the data from [10.2](#) or [10.3](#):

11.1.1 *Test Fraction*—Determine the dry mass of the test fraction as follows:

$$M_{d,tf} = \frac{M_{m,tf}}{1 + \frac{w_{tf}}{100}} \quad (1)$$

where:

- $M_{d,tf}$  = dry mass of test fraction, nearest g or 0.001 kg,
- $M_{m,tf}$  = moist mass of test fraction, nearest g or 0.001 kg, and
- $w_{tf}$  = water content of test fraction, nearest 0.1 %.

11.1.2 *Oversize Fraction Percentage*—Determine the oversize (coarse) fraction percentage as follows:

$$P_C = \frac{M_{d,of}}{M_{d,of} + M_{d,tf}} \quad (2)$$

where:

- $P_C$  = percentage of oversize (coarse) fraction, nearest %, and
- $M_{d,of}$  = dry mass of oversize fraction, nearest g or 0.001 kg,

11.1.3 *Test Fraction Percentage*—Determine the test (finer) fraction percentage as follows:

$$P_F = 100 - P_C \quad (3)$$

where:

- $P_F$  = percentage of test (finer) fraction, nearest %.

11.2 *Density and Unit Weight*—Calculate the molding water content, moist density, dry density, and dry unit weight of each compacted specimen as explained below.

11.2.1 *Molding Water Content,  $w$* —Calculate in accordance with Test Methods [D2216](#) to nearest 0.1 %.

11.2.2 *Density and Unit Weights*—Calculate the moist (total) density ([Eq 4](#)), the dry density ([Eq 5](#)), and then the dry unit weight ([Eq 6](#)) as follows:

11.2.2.1 *Moist Density:*

$$\rho_m = K \times \frac{(M_t - M_{md})}{V} \quad (4)$$

where:

- $\rho_m$  = moist density of compacted subspecimen (compaction point), four significant digits, g/cm<sup>3</sup> or kg/m<sup>3</sup>,
- $M_t$  = mass of moist soil in mold and mold, nearest g,
- $M_{md}$  = mass of compaction mold, nearest g,
- $V$  = volume of compaction mold, cm<sup>3</sup> or m<sup>3</sup> (see [Annex A1](#)), and

$K$  = conversion constant, depending on density units and volume units.

Use 1 for  $\text{g}/\text{cm}^3$  and volume in  $\text{cm}^3$ .

Use 1000 for  $\text{g}/\text{cm}^3$  and volume in  $\text{m}^3$ .

Use 0.001 for  $\text{kg}/\text{cm}^3$  and volume in  $\text{m}^3$ .

Use 1000 for  $\text{kg}/\text{m}^3$  and volume in  $\text{cm}^3$ .

#### 11.2.2.2 Dry Density:

$$\rho_d = \frac{\rho_m}{1 + \frac{w}{100}} \quad (5)$$

where:

$\rho_d$  = dry density of compaction point, four significant digits,  $\text{g}/\text{cm}^3$  or  $\text{kg}/\text{m}^3$ , and

$w$  = molding water content of compaction point, nearest 0.1 %.

#### 11.2.2.3 Dry Unit Weight:

$$\gamma_d = K_1 \times \rho_d \text{ in lbf}/\text{ft}^3 \quad (6)$$

or

$$\gamma_d = K_2 \times \rho_d \text{ in kN}/\text{m}^3 \quad (7)$$

where:

$\gamma_d$  = dry unit weight of compacted specimen, four significant digits, in  $\text{lbf}/\text{ft}^3$  or  $\text{kN}/\text{m}^3$ ,

$K_1$  = conversion constant, depending on density units,

Use 62.428 for density in  $\text{g}/\text{cm}^3$ , or

Use 0.062428 for density in  $\text{kg}/\text{m}^3$ ,

$K_2$  = conversion constant, depending on density units,

Use 9.8066 for density in  $\text{g}/\text{cm}^3$ , or

Use 0.0098066 for density in  $\text{kg}/\text{m}^3$ .

**11.3 Compaction Curve**—Plot the dry unit weight and molding water content values, the saturation curve (see 11.3.2), and draw the compaction curve as a smooth curve through the points (see example, Fig. 5). For each point on the compaction curve, calculate, record, and plot dry unit weight to the nearest 0.1  $\text{lbf}/\text{ft}^3$  (0.02  $\text{kN}/\text{m}^3$ ) and molding water content to the nearest 0.1 %. From the compaction curve, determine the compaction results: optimum water content, to nearest 0.1 % and maximum dry unit weight, to the nearest 0.1  $\text{lbf}/\text{ft}^3$  (0.02  $\text{kN}/\text{m}^3$ ). If more than 5 % by mass of oversize material was removed from the sample/specimen, calculate the corrected optimum water content and maximum dry unit weight of the total material using Practice D4718. This correction may be made to the appropriate field in-place density test specimen rather than to the laboratory compaction results.

11.3.1 In these plots, the scale sensitivities should remain the same, that is the change in molding water content or dry unit weight per division is constant between plots. Typically, the change in dry unit weight per division is twice that of molding water content's (2  $\text{lbf}/\text{ft}^3$  to 1 %  $w$  per major division). Therefore, any change in the shape of the compaction curve is a result of testing different material, not the plotting scale. However, a one to one ratio should be used for soils that have a relatively flat compaction curve (see 10.2.1), such as highly plastic soils or relatively free draining ones up to the point of bleeding.

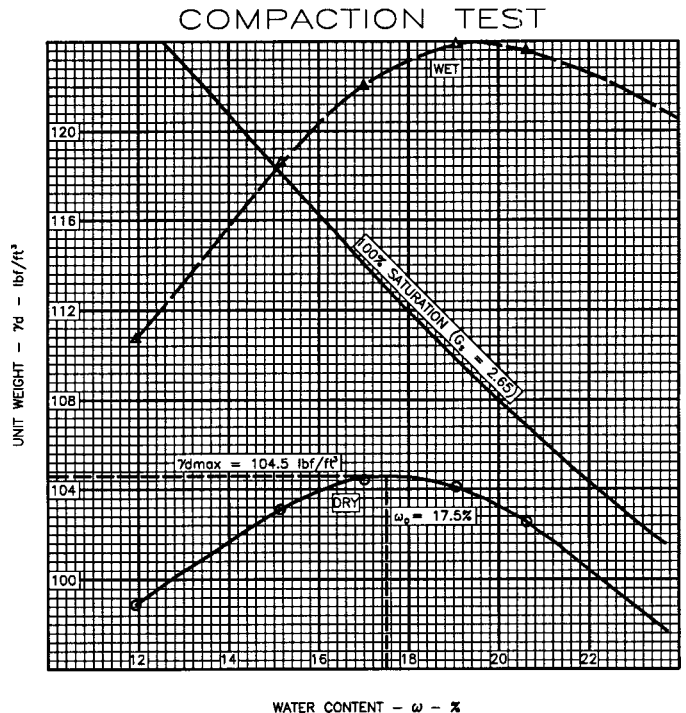

FIG. 5 Example Compaction Curve Plotting

11.3.1.1 The shape of the compaction curve on the wet side on optimum should typically follow that of the saturation curve. The shape of the compaction curve on the dry side of optimum may be relatively flat or up and down when testing some soils, such as relatively free draining ones or plastic soils prepared using the moist procedure and having molding water contents close to or less than the shrinkage limit.

11.3.2 Plot the 100 % saturation curve, based on either an estimated or a measured specific gravity. Values of water content for the condition of 100 % saturation can be calculated as explained in 11.4 (see example, Fig. 5).

NOTE 10—The 100 % saturation curve is an aid in drawing the compaction curve. For soils containing more than about 10 % fines and molding water contents well above optimum, the two curves generally become roughly parallel with the wet side of the compaction curve between 92 to 95 % saturation. Theoretically, the compaction curve cannot plot to the right of the 100 % saturation curve. If it does, there is an error in specific gravity, in measurements, in calculations, in testing, or in plotting. The 100 % saturation curve is sometimes referred to as the zero air voids curve or the complete saturation curve.

11.4 **Saturation Points**—To calculate points for plotting the 100 % saturation curve or zero air voids curve, select values of dry unit weight, calculate corresponding values of water content corresponding to the condition of 100 % saturation as follows:

$$w_{sat} = \frac{(\gamma_w)(G_s) - \gamma_d}{(\gamma_d)(G_s)} \times 100 \quad (8)$$

where:

$w_{sat}$  = water content for complete saturation, nearest 0.1 %,

$\gamma_w$  = unit weight of water, 62.32  $\text{lbf}/\text{ft}^3$  (9.789  $\text{kN}/\text{m}^3$ ) at 20°C,



$\gamma_d$  = dry unit weight of soil, lbf/ft<sup>3</sup> (kN/m<sup>3</sup>), three significant digits, and  
 $G_s$  = specific gravity of soil (estimated or measured), to nearest 0.01 value, see 11.4.1.

11.4.1 Specific gravity may be estimated for the test fraction based on test data from other soils having the same soil classification and source or experience. Otherwise, a specific gravity test (Test Methods C127 or D854, or both) is necessary.

**12. Report: Data Sheet(s)/Form(s)**

12.1 The methodology used to specify how data are recorded on the test data sheet(s)/form(s), as described below, is covered in 1.6.

12.2 The data sheet(s)/form(s) shall contain as a minimum the following information:

- 12.2.1 Method used (A, B, or C).
- 12.2.2 Preparation method used (moist or dry).
- 12.2.3 As received water content if determined, nearest 1 %.
- 12.2.4 Standard optimum water content, Std- $w_{opt}$  to nearest 0.1 %.
- 12.2.5 Standard maximum dry unit weight, Std- $\gamma_{d,max}$  nearest 0.1 lbf/ft<sup>3</sup> or 0.02 kN/m<sup>3</sup>.
- 12.2.6 Type of rammer (manual or mechanical).
- 12.2.7 Soil sieve data when applicable for selection of Method (A, B, or C) used.
- 12.2.8 Description of sample used in test (as a minimum, color and group name and symbol), by Practice D2488, or classification by Practice D2487.
- 12.2.9 Specific gravity and method of determination, nearest 0.01 value.
- 12.2.10 Identification of sample used in test; for example, project number/name, location, depth, and the like.
- 12.2.11 Compaction curve plot showing compaction points used to establish compaction curve, and 100 % saturation curve, value or point of maximum dry unit weight and optimum water content.
- 12.2.12 Percentages for the fractions retained ( $P_C$ ) and passing ( $P_F$ ) the sieve used in Method A, B, or C, nearest 1 %. In addition, if compaction data (Std- $w_{opt}$  and Std- $\gamma_{d,max}$ ) are corrected for the oversize fraction, include that data.

**13. Precision and Bias**

13.1 Precision—Criteria for judging the acceptability of test results obtained by these test methods on a range of soil types are given in Tables 3 and 4. These estimates of precision are based on the results of the interlaboratory program conducted by the ASTM Reference Soils and Testing Program.<sup>4</sup> In this program, Method A and the Dry Preparation Method were used. In addition, some laboratories performed three replicate tests per soil type (triplicate test laboratory), while other laboratories performed a single test per soil type (single test laboratory). A description of the soils tested is given in 13.1.4. The precision estimates vary with soil type, and may vary with methods used (Method A, B, or C, or wet/dry preparation

<sup>4</sup> Supporting data have been filed at ASTM International Headquarters and may be obtained by requesting Research Report RR:D18-1008. Contact ASTM Customer Service at service@astm.org.

**TABLE 3 Summary of Test Results from Triplicate Test Laboratories (Standard Effort Compaction)**

(1) Number of Triplicate Test Labs			(2) Test Value <sup>A</sup> (Units)	(3) Average Value <sup>B</sup>	(4) Standard Deviation <sup>C</sup>	(5) Acceptable Range of Two Results <sup>D,E</sup>
<i>Soil Type:</i>						
CH	CL	ML	CH CL ML	CH CL ML	CH CL ML	CH CL ML
<i>Single-Operator Results (Within-Laboratory Repeatability):</i>						
11	12	11	$\gamma_{d,max}$ (pcf)	97.2 109.2 106.3	0.5 0.4 0.5	1.3 1.2 1.3
11	12	11	$w_{opt}$ (%)	22.8 16.6 17.1	0.2 0.3 0.3	0.7 0.9 0.9
<i>Multilaboratory Results (Between-Laboratory Reproducibility):</i>						
11	12	11	$\gamma_{d,max}$ (pcf)	97.2 109.2 106.3	1.4 0.8 0.6	3.9 2.3 1.6
11	12	11	$w_{opt}$ (%)	22.8 16.6 17.1	0.7 0.5 0.5	1.8 1.5 1.3

<sup>A</sup>  $\gamma_{d,max}$ (pcf) = standard maximum dry unit weight in lbf/ft<sup>3</sup> and  $w_{opt}$ (%) = standard optimum water in percent.  
<sup>B</sup> The number of significant digits and decimal places presented are representative of the input data. In accordance with Practice D6026, the standard deviation and acceptable range of results can not have more decimal places than the input data.  
<sup>C</sup> Standard deviation is calculated in accordance with Practice E691 and is referred to as the 1 s limit.  
<sup>D</sup> Acceptable range of two results is referred to as the d2s limit. It is calculated as  $1.960 \sqrt{2} \cdot 1s$ , as defined by Practice E177. The difference between two properly conducted tests should not exceed this limit. The number of significant digits/decimal places presented is equal to that prescribed by this standard or Practice D6026. In addition, the value presented can have the same number of decimal places as the standard deviation, even if that result has more significant digits than the standard deviation.  
<sup>E</sup> Both values of  $\gamma_{d,max}$  and  $w_{opt}$  have to fall within values given for the selected soil type.

**TABLE 4 Summary of Single Test Results from Each Laboratories (Standard Effort Compaction)<sup>A</sup>**

(1) Number of Test Laboratories			(2) Test Value (Units)	(3) Average Value	(4) Standard Deviation	(5) Acceptable Range of Two Results
<i>Soil Type:</i>						
CH	CL	ML	CH CL ML	CH CL ML	CH CL ML	CH CL ML
<i>Multilaboratory Results (Between-Laboratory Reproducibility):</i>						
26	26	25	$\gamma_{d,max}$ (pcf)	97.3 109.2 106.2	1.6 1.1 1.0	4.5 3.0 2.9
			$w_{opt}$ (%)	22.6 16.4 16.7	0.9 0.7 1.0	2.4 1.8 2.9

<sup>A</sup> See footnotes in Table 3.

method). Judgement is required when applying these estimates to another soil, method, or preparation method.

13.1.1 The data in Table 3 are based on three replicate tests performed by each triplicate test laboratory on each soil type. The single operator and multilaboratory standard deviation show in Table 3, Column 4 were obtained in accordance with Practice E691, which recommends each testing laboratory perform a minimum of three replicate tests. Results of two properly conducted tests performed by the same operator on the same material, using the same equipment, and in the shortest practical period of time should not differ by more than the single-operator d2s shown in Table 3, Column 5. For definition of d2s, see footnote D in Table 1. Results of two properly conducted tests performed by different operators and on different days should not differ by more than the multilaboratory d2s limits shown in Table 3, Column 5.

13.1.2 In the ASTM Reference Soils and Testing Program, many of the laboratories performed only a single test on each



soil type. This is common practice in the design and construction industry. The data for each soil type in Table 4 are based upon the first test result from the triplicate test laboratories and the single test results from the other laboratories. Results of two properly conducted tests performed by two different laboratories with different operators using different equipment and on different days should not vary by more than the  $d_{2s}$  limits shown in Table 4, Column 5. The results in Tables 3 and 4 are dissimilar because the data sets are different.

13.1.3 Table 3 presents a rigorous interpretation of triplicate test data in accordance with Practice E691 from pre-qualified laboratories. Table 4 is derived from test data that represents common practice.

13.1.4 *Soil Types*—Based on the multilaboratory test results the soils used in the program are described below in accordance with Practice D2487. In addition, the local names of the soils are given.

CH	Fat clay, CH, 99 % fines, LL=60, PI=39, grayish brown, soil had been air dried and pulverized. Local name—Vicksburg Buckshot Clay
CL	Lean clay, CL, 89 % fines, LL=33, PI=13, gray, soil had been air dried and pulverized. Local name—Annapolis Clay
ML	Silt, ML, 99 % fines, LL=27, PI=4, light brown, soil had been air dried and pulverized. Local name—Vicksburg Silt

13.2 *Bias*—There is no accepted reference values for this test method, therefore, bias cannot be determined.

## 14. Keywords

14.1 compaction characteristics; density; impact compaction; laboratory tests ; moisture-density curves; proctor test; soil; soil compaction; standard effort

## ANNEX

### (Mandatory Information)

#### A1. VOLUME OF COMPACTION MOLD

##### A1.1 Scope

A1.1.1 This annex describes the procedure for determining the volume of a compaction mold.

A1.1.2 The volume is determined by two methods, a water-filled and linear-measurement method.

A1.1.3 The water filling method for the 4-in. (106.5-mm) mold, when using a balance readable to nearest g, does not yield four significant figures for its volume, just three. Based on Practice D6026, this limits the density/unit weight determinations previously presented from four to three significant figures. To prevent this limitation, the water filling method has been adjusted from that presented in early versions of this test method.

##### A1.2 Apparatus

A1.2.1 In addition to the apparatus listed in Section 6 the following items are required:

A1.2.1.1 *Vernier or Dial Caliper*, having a measuring range of at least 0 to 6 in. (0 to 150 mm) and readable to at least 0.001 in. (0.02 mm).

A1.2.1.2 *Inside Micrometer (optional)*, having a measuring range of at least 2 to 12 in. (50 to 300 mm) and readable to at least 0.001 in. (0.02 mm).

A1.2.1.3 *Depth Micrometer (optional)*, having a measuring range of at least 0 to 6 in. (0 to 150 mm) and readable to at least 0.001 in. (0.02 mm).

A1.2.1.4 *Plastic or Glass Plates*—Two plastic or glass plates about 8 in. square by ¼ in. thick (200 by 200 by 6 mm).

A1.2.1.5 *Thermometer or Other Thermometric Device*, having graduation increments of 0.1°C.

A1.2.1.6 *Stopcock Grease*, or similar sealant.

A1.2.1.7 *Miscellaneous Equipment*—Bulb syringe, towels, etc.

##### A1.3 Precautions

A1.3.1 Perform this method in an area isolated from drafts or extreme temperature fluctuations.

##### A1.4 Procedure

A1.4.1 *Water-Filling Method*:

A1.4.1.1 Lightly grease the bottom of the compaction mold and place it on one of the plastic or glass plates. Lightly grease the top of the mold. Be careful not to get grease on the inside of the mold. If it is necessary to use the base plate, as noted in 10.4.7, place the greased mold onto the base plate and secure with the locking studs.

A1.4.1.2 Determine the mass of the greased mold and both plastic or glass plates to the nearest 1 g and record,  $M_{mp}$ . When the base plate is being used in lieu of the bottom plastic or glass plate, determine the mass of the mold, base plate and a single plastic or glass plate to be used on top of the mold to the nearest 1 g and record.

A1.4.1.3 Place the mold and the bottom plastic or glass plate on a firm, level surface and fill the mold with water to slightly above its rim.

A1.4.1.4 Slide the second plate over the top surface of the mold so that the mold remains completely filled with water and air bubbles are not entrapped. Add or remove water as necessary with a bulb syringe.

A1.4.1.5 Completely dry any excess water from the outside of the mold and plates.

A1.4.1.6 Determine the mass of the mold, plates and water and record to the nearest 1 g,  $M_{mp,w}$ .





A1.4.1.7 Determine the temperature of the water in the mold to the nearest 0.1°C and record. Determine and record the density of water from the table given in Test Methods D854 or as follows:

$$\rho_{w,c} = 1.00034038 - (7.77 \times 10^{-6}) \times T - (4.95 \times 10^{-6}) \times T^2 \quad (\text{A1.1})$$

where:

$\rho_{w,c}$  = density of water, nearest 0.00001 g/cm<sup>3</sup>, and  
 $T$  = calibration test temperature, nearest 0.1°C.

A1.4.1.8 Calculate the mass of water in the mold by subtracting the mass determined in A1.4.1.2 from the mass determined in A1.4.1.6.

A1.4.1.9 Calculate the volume of water by dividing the mass of water by the density of water. Record this volume to the nearest 0.1 cm<sup>3</sup> for the 4-in. (101.6-mm) mold or nearest 1 cm<sup>3</sup> for the 6-in. (152.4-mm) mold. To determine the volume of the mold in m<sup>3</sup>, multiply the volume in cm<sup>3</sup> by 1 × 10<sup>-6</sup>. Record this volume, as prescribed.

A1.4.1.10 If the filling method is being used to determine the mold's volume and checked by linear measurement method, repeat this volume determination (A1.4.1.3 – A1.4.1.9) and determine and record the average value,  $V_w$  as prescribed.

#### A1.4.2 Linear Measurement Method:

A1.4.2.1 Using either the vernier caliper or the inside micrometer (preferable), measure the inside diameter (ID) of the mold 6 times at the top of the mold and 6 times at the bottom of the mold, spacing each of the six top and bottom measurements equally around the ID of the mold. Record the values to the nearest 0.001-in. (0.02-mm). Determine and record the average ID to the nearest 0.001-in. (0.02-mm),  $d_{avg}$ . Verify that this ID is within specified tolerances, 4.000 ± 0.016 in. (101.6 ± 0.4 mm), if not discard the mold.

A1.4.2.2 Using the vernier caliper or depth micrometer (preferably), measure the inside height of the mold attached to the base plate. In these measurements, make three or more measurements equally spaced around the ID of the mold, and preferably one in the center of the mold, but not required (used the straightedge to facilitate the later measurement and correct measurement for thickness of straightedge). Record these values to the nearest 0.001-in. (0.02-mm). Determine and

record the average of these height measurements to the nearest 0.001 in. (0.02 mm),  $h_{avg}$ . Verify that this height is within specified tolerances, 4.584 ± 0.018 in. (116.4 ± 0.5 mm), if not discard the mold.

A1.4.2.3 Calculate the volume of the mold to four significant digits in cm<sup>3</sup> as follows:

$$V_{lm} = K_3 \frac{\pi \times h_{avg} \times (d_{avg})^2}{4} \quad (\text{A1.2})$$

where:

$V_{lm}$  = volume of mold by linear measurements, to four significant digits, cm<sup>3</sup>,

$K_3$  = constant to convert measurements made in inch (in.) or mm,

Use 16.387 for measurements in inches.

Use 10<sup>-6</sup> for measurements in mm.

$\pi$  = 3.14159,

$h_{avg}$  = average height, in. (mm), and

$d_{avg}$  = average of the top and bottom diameters, in. (mm).

A1.4.2.4 If the volume in m<sup>3</sup> is required, then multiply the above value by 10<sup>-6</sup>.

### A1.5 Comparison of Results and Standardized Volume of Mold

A1.5.1 The volume obtained by either method should be within the volume tolerance requirements of 6.1.1 and 6.1.2, using either or cm<sup>3</sup> to ft<sup>3</sup>. To convert cm<sup>3</sup> to ft<sup>3</sup>, divide cm<sup>3</sup> by 28 317, record to the nearest 0.0001 ft<sup>3</sup>.

A1.5.2 The difference between the two methods should not exceed 0.5 % of the nominal volume of the mold, cm<sup>3</sup> to ft<sup>3</sup>.

A1.5.3 Repeat the determination of volume, which is most suspect or both if these criteria are not met.

A1.5.4 Failure to obtain satisfactory agreement, between these methods, even after several trials is an indication the mold is badly deformed and should be replaced.

A1.5.5 Use the volume of the mold determined using the water-filling or linear method, or average of both methods as the standardized volume for calculating the moist density (see 11.4). This value ( $V$ ) in cm<sup>3</sup> or m<sup>3</sup> shall have four significant digits. The use of a volume in ft<sup>3</sup>, along with masses in lbm shall not be regarded as a nonconformance with this standard.

D698 – 12<sup>e1</sup>

## REFERENCES

- (1) Johnson, A. W., and Sallberg, J. R., *Factors Influencing Compaction Test Results*, Highway Research Board, Bulletin 318, Publication 967, National Academy of Sciences-National Research Council, Washington, DC, 1962.
- (2) *Earth Manual*, United States Bureau of Reclamation, Part 1, Third Edition, 1998, pp. 255–260.
- (3) *Earth Manual*, United States Bureau of Reclamation, Part 2, Third Edition, 1990, USBR 5515.
- (4) Torrey, V. H., and Donaghe, R. T., “Compaction Control of Earth-Rock Mixtures: A New Approach,” *Geotechnical Testing Journal*, GTJODJ, Vol 17, No. 3, September 1994, pp. 371–386.

## SUMMARY OF CHANGES

Committee D18 has identified the location of selected changes to this standard since the last issue (D698–07<sup>e1</sup>) that may impact the use of this standard. (Approved May 1, 2012.)

- (1) Revised 6.2.2.1 and 10.4.5.

*ASTM International takes no position respecting the validity of any patent rights asserted in connection with any item mentioned in this standard. Users of this standard are expressly advised that determination of the validity of any such patent rights, and the risk of infringement of such rights, are entirely their own responsibility.*

*This standard is subject to revision at any time by the responsible technical committee and must be reviewed every five years and if not revised, either reapproved or withdrawn. Your comments are invited either for revision of this standard or for additional standards and should be addressed to ASTM International Headquarters. Your comments will receive careful consideration at a meeting of the responsible technical committee, which you may attend. If you feel that your comments have not received a fair hearing you should make your views known to the ASTM Committee on Standards, at the address shown below.*

*This standard is copyrighted by ASTM International, 100 Barr Harbor Drive, PO Box C700, West Conshohocken, PA 19428-2959, United States. Individual reprints (single or multiple copies) of this standard may be obtained by contacting ASTM at the above address or at 610-832-9585 (phone), 610-832-9555 (fax), or service@astm.org (e-mail); or through the ASTM website (www.astm.org). Permission rights to photocopy the standard may also be secured from the ASTM website (www.astm.org/COPYRIGHT/).*





**APPENDIX D**

**ASTM Standard D1140  
Amount of Material in Soils Finer than No. 200 (75- $\mu$ m) Sieve**



Designation: D1140 – 00 (Reapproved 2006)

## Standard Test Methods for Amount of Material in Soils Finer than No. 200 (75- $\mu$ m) Sieve<sup>1</sup>

This standard is issued under the fixed designation D1140; the number immediately following the designation indicates the year of original adoption or, in the case of revision, the year of last revision. A number in parentheses indicates the year of last reapproval. A superscript epsilon ( $\epsilon$ ) indicates an editorial change since the last revision or reapproval.

*This standard has been approved for use by agencies of the Department of Defense.*

### 1. Scope

1.1 These test methods cover determination of the amount of material finer than a 75- $\mu$ m (No. 200) sieve by washing.

1.2 Two methods for determining the amount of material finer than the No. 200 sieve are provided. The method to be used shall be specified by the requesting authority. If no method is specified, the choice should be based on the guidance given in 4.2 and 7.3

1.2.1 *Method A*—Test specimen is not dispersed prior to wash sieving.

1.2.2 *Method B*—Test specimen is dispersed by soaking in water containing a deflocculating agent prior to wash sieving.

1.3 The values stated in SI units are to be regarded as the standard.

1.4 *This standard does not purport to address all of the safety concerns, if any, associated with its use. It is the responsibility of the user of this standard to establish appropriate safety and health practices and determine the applicability of regulatory limitations prior to use.*

### 2. Referenced Documents

2.1 *ASTM Standards*:<sup>2</sup>

[C702 Practice for Reducing Samples of Aggregate to Testing Size](#)

[D75 Practice for Sampling Aggregates](#)

[D422 Test Method for Particle-Size Analysis of Soils](#)

[D2216 Test Methods for Laboratory Determination of Water \(Moisture\) Content of Soil and Rock by Mass](#)

[D2487 Practice for Classification of Soils for Engineering Purposes \(Unified Soil Classification System\)](#)

<sup>1</sup> These test methods are under the jurisdiction of ASTM Committee D18 on Soil and Rock and is the direct responsibility of Subcommittee D18.03 on Texture, Plasticity and Density Characteristics of Soils.

Current edition approved Nov. 15, 2006. Published January 2007. Originally approved in 1950. Last previous edition approved in 2000 as D1140–00. DOI: 10.1520/D1140-00R06.

<sup>2</sup> For referenced ASTM standards, visit the ASTM website, [www.astm.org](http://www.astm.org), or contact ASTM Customer Service at [service@astm.org](mailto:service@astm.org). For *Annual Book of ASTM Standards* volume information, refer to the standard's Document Summary page on the ASTM website.

[D3740 Practice for Minimum Requirements for Agencies Engaged in Testing and/or Inspection of Soil and Rock as Used in Engineering Design and Construction](#)

[D4753 Guide for Evaluating, Selecting, and Specifying Balances and Standard Masses for Use in Soil, Rock, and Construction Materials Testing](#)

[D6026 Practice for Using Significant Digits in Geotechnical Data](#)

[E11 Specification for Woven Wire Test Sieve Cloth and Test Sieves](#)

[E145 Specification for Gravity-Convection and Forced-Ventilation Ovens](#)

[E177 Practice for Use of the Terms Precision and Bias in ASTM Test Methods](#)

[E691 Practice for Conducting an Interlaboratory Study to Determine the Precision of a Test Method](#)

### 3. Summary of Test Method

3.1 A specimen of the soil is washed over a 75- $\mu$ m (No. 200) sieve. Clay and other particles that are dispersed by the wash water, as well as water-soluble materials, are removed from the soil during the test. The loss in mass resulting from the wash treatment is calculated as mass percent of the original sample and is reported as the percentage of material finer than a 75- $\mu$ m (No. 200) sieve by washing.

### 4. Significance and Use

4.1 Material finer than the 75- $\mu$ m (No. 200) sieve can be separated from larger particles much more efficiently and completely by wet sieving than with dry sieving. Therefore, when accurate determinations of material finer than 75- $\mu$ m sieve in soil are desired, this test method is used on the test specimen prior to dry sieving. Usually the additional amount of material finer than 75- $\mu$ m sieve obtained in the dry sieving process is a small amount. If it is large, the efficiency of the washing operation should be checked, as it could be an indication of degradation of the soil.

4.2 With some soils, particularly clayey soils, in order to keep the finer material from adhering to the larger particles, it will be necessary to soak the soil prior to washing it through



the sieve. A deflocculating agent (dispersing agent) should be added to the soil when it is soaked.

NOTE 1—The quality of the result produced by this standard is dependent on the competence of the personnel performing it, and the suitability of the equipment and facilities used. Agencies that meet the criteria of Practice D3740 are generally considered capable of competent and objective testing/sampling/inspection/etc. Users of this standard are cautioned that compliance with Practice D3740 does not in itself assure reliable results. Reliable results depend on many factors; Practice D3740 provides a means of evaluating some of those factors.

## 5. Apparatus

5.1 *Balance*—A balance or scale conforming to the requirements of Specification D4753, readable (with no estimation) to 0.1 % of the test mass, or better. To determine the balance needed, multiply your test mass by 0.001 and check Table 1 of Specification D4753 for the class of balance readable to the number observed.

5.2 *Sieves*—A minimum nest of two sieves is recommended, the lower must be a 75- $\mu\text{m}$  (No. 200) sieve and the upper may be a 425- $\mu\text{m}$  (No. 40) or larger sieve. Choose a sieve with a diameter sufficient to handle the size of specimen required by 6.2. The 75- $\mu\text{m}$  sieve should have a backing to prevent damage. The sieves shall conform to the requirements of Specification E11. Stainless sieve mesh is preferred, as it is less prone to damage or wear.

5.3 *Oven*—An oven of sufficient size, capable of maintaining a uniform temperature of  $100 \pm 5^\circ\text{C}$  ( $230 \pm 9^\circ\text{F}$ ) and which meets the criteria of Specification E145.

5.4 *Deflocculating Agent*—A solution of Sodium Hexametaphosphate of any concentration sufficient to cause particle separation can be used. A common amount is 40 g per 1000 mL of water.

## 6. Sampling

6.1 Sample the soil in accordance with Practice D75.

6.2 Thoroughly mix the soil sample and reduce the quantity to an amount suitable for testing using the applicable method described in Practice C702. The test specimen shall be the end result of the reduction. Reduction to an exact predetermined mass is not permitted. The mass of the test specimen, after drying, shall conform with the following except as noted (6.2.1 and Note 2):

Maximum Particle Size (100 % Passing)	Standard Sieve Size	Recommended Minimum Mass of Test Specimens
2 mm or less	No. 10	20 g
4.75 mm	No. 4	100 g
9.5 mm	$\frac{3}{8}$ "	500 g
19.0 mm	$\frac{3}{4}$ "	2.5 kg
37.5 mm	$1\frac{1}{2}$ "	10 kg
75.0 mm	3"	50 kg

6.2.1 If the same specimen is to be tested for sieve analysis according to Test Method D422, comply with the applicable mass requirements of that Test Method.

NOTE 2—When a minimum mass is not available (split spoon sample, and the like), a smaller mass can be used. The report shall indicate the mass used.

## 7. Procedure

7.1 Dry the test specimen to a constant mass at a temperature of  $110 \pm 5^\circ\text{C}$  ( $230 \pm 9^\circ\text{F}$ ) and determine its mass to the nearest 0.1 g. To determine the balance needed, multiply the mass by 0.001, check the resultant number with Table 1 of Specification D4753 for the required balance.

7.1.1 For example: Minimum readability =  $276 \text{ g (mass)} \times 0.001 = 0.3 \text{ g}$ . A GP-2 with a readability of 0.1 g would be suitable. A more sensitive balance could also be used.

7.1.2 As an alternative, select an auxiliary water content specimen and determine the water content (nearest 0.1 %) in accordance with Test Method D2216. Calculate the oven-dry mass of the test specimen from the moist mass (nearest 0.1 % of its mass, or better (see 5.1)) and the water content.

### 7.2 Method A:

7.2.1 After preparing the specimen in accordance with 7.1, place the specimen on the uppermost (coarsest) sieve. Wash the specimen (material) on the sieve(s) by means of a stream of water from a faucet (Note 3). The material may be lightly manipulated by hand, to facilitate the washing process, taking care not to lose any of the retained material. No downward pressure should be exerted on the retained material or sieve to avoid the forcing of particles through the sieve or damage to the sieve. Continue the washing until the water coming through the sieve(s) is clear (Note 4).

NOTE 3—A spray nozzle or a piece of rubber tubing attached to a water faucet may be used for the washing. The velocity of the water, which may be increased by pinching the tubing, shall not cause any splashing of the material over the sides of the sieve. The water temperature should not exceed  $32^\circ\text{C}$  ( $90^\circ\text{F}$ ) to avoid expanding the sieve fabric.

NOTE 4—Care should be taken not to let water accumulate on the 75- $\mu\text{m}$  (No. 200) sieve due to clogging of the screen. The clogging can cause overflow of the sieve and loss of material. Lightly hand tapping the sides of the sieve or the bottom of the screen with a fingertip(s) should prevent clogging. Directing a stream of water up from below the screen is another method to unplug the sieve without physically damaging it. Be careful not to overload the screen by sieving too large a specimen, or portion of a specimen, at any one time.

### 7.3 Method B:

7.3.1 As an alternative, particularly for very cohesive soils; after preparing the specimen in accordance with 7.1, place the specimen in a container, cover with water containing a deflocculating agent, and soak for a minimum of 2 h (preferably overnight) (Note 5). The specimen should be periodically agitated manually or by mechanical means to facilitate the complete separation of the particles.

NOTE 5—It will also be easier to separate the particles if the specimen is not dried prior to soaking. The moist mass can be adjusted to a dry mass by using the water content determination procedure from 7.1.2.

7.3.2 After the soaking period is completed, agitate the contents of the container vigorously and immediately pour into the nested sieves. Wash any remaining material into the sieve(s) to make sure all of the material is transferred. Then finish the washing procedure as specified in 7.2.

7.4 When the washing by Method A or B is completed, the material retained on the 75- $\mu\text{m}$  (No. 200) sieve can be dried either in the sieve, or by flushing (transferring) the contents of the sieve into another container. If the soil is transferred, excess



water can be removed by decanting or suctioning to speed drying time. Take care not to lose any particles by removing only clear water.

7.4.1 Dry the residue from each sieve to a constant mass using a temperature of  $110 \pm 5^\circ\text{C}$  ( $230 \pm 9^\circ\text{F}$ ) and determine the mass using the same balance as used in 7.1.

NOTE 6—As mentioned in 4.1, if the sample is dry sieved after washing, some material will pass the 75- $\mu\text{m}$  (No. 200) sieve that did not pass during washing operations. This can be a significant amount for samples with a high percent of very fine sand or coarse silt.

## 8. Calculation

8.1 Calculate the amount of material passing the 75- $\mu\text{m}$  (No. 200) sieve by washing using the following formula:

$$A = [(B - C)/B] \times 100 \quad (1)$$

where:

- A = percentage of material finer than the 75- $\mu\text{m}$  sieve by washing, nearest 0.1 %
- B = original dry mass of sample, g, and
- C = dry mass of specimen retained on the 75- $\mu\text{m}$  sieve including the amount retained on an upper sieve after washing, g.

## 9. Report

9.1 Report the percentage of material finer than the 75- $\mu\text{m}$  (No. 200) sieve by washing to the nearest 0.1 %.

9.2 Indicate whether the specimen was soaked and length of time.

9.3 Indicate method used (A or B).

9.4 Sample identification.

9.5 Size of initial dry mass used.

9.6 State whether the dry mass was determined directly or using the water content of the specimen as directed in 7.1.2. If so, note the water content.

## 10. Precision and Bias

10.1 *Precision*—Criteria for judging the acceptability of test results obtained by these test methods on a range of soil types using Method B are given in Tables 1 and 2. These estimates of precision are based on the results of the interlaboratory program conducted by the ASTM Reference Soils and Testing Program<sup>3</sup>. In this program, some laboratories performed three replicate tests per soil type (triplicate test laboratory), while other laboratories performed a single test per soil type (single test laboratory). A description of the soils tested is given in 10.1.4. The precision estimates may vary with soil type and method used (Method A or B). Judgment is required when applying these estimates to another soil or method.

10.1.1 The data in Table 1 are based on three replicate tests performed by each triplicate test laboratory on each soil type. The single operator and multilaboratory standard deviation shown in Table 1, Column 4 were obtained in accordance with Practice E691, which recommends each testing laboratory

<sup>3</sup> Supporting data have been filed at ASTM International Headquarters and may be obtained by requesting Research Report RR:D18-1010.

**TABLE 1 Summary of Test Results from Triplicate Test Laboratories (Percent of Fines)**

(1) Soil Type	(2) Number of Triplicate Test Laboratories	(3) Average Value <sup>A</sup> (Percentage Points)	(4) Standard Deviation <sup>B</sup> (Percentage Points)	(5) Acceptable Range of Two Results <sup>C</sup> (Percentage Points)
<i>Single-Operator Results (Within-Laboratory Repeatability):</i>				
CH	13	98.83	0.15	0.4
CL	13	88.55	0.14	0.4
ML	14	99.00	0.12	0.3
SP	13	2.47	0.20	0.5
<i>Multilaboratory Results (Between-Laboratory Reproducibility):</i>				
CH	13	98.83	0.22	0.6
CL	13	88.55	0.40	1.1
ML	14	99.00	0.13	0.4
SP	13	2.47	0.36	1.0

<sup>A</sup>The number of significant digits and decimal places presented are representative of the input data. In accordance with Practice D6026, the standard deviation and acceptable range of results can not have more decimal places than the input data.

<sup>B</sup>Standard deviation is calculated in accordance with Practice E691 and is referred to as the 1s limit.

<sup>C</sup>Acceptable range of two results is referred to as the d2s limit. It is calculated as  $1.960 \sqrt{2} \cdot 1s$ , as defined by Practice E177. The difference between two properly conducted tests should not exceed this limit. The number of significant digits/decimal places presented is equal to that prescribed by this test method or Practice D6026. In addition, the value presented can have the same number of decimal places as the standard deviation, even if that result has more significant digits than the standard deviation.

**TABLE 2 Summary of Single-Test Result from Each Laboratory (Percent of Fines)<sup>A</sup>**

(1) Soil Type	(2) Number of Test Laboratories	(3) Average Value (Percentage Points)	(4) Standard Deviation (Percentage Points)	(5) Acceptable Range of Two Results (Percentage Points)
<i>Multilaboratory Results (Single Test Performed by Each Laboratory):</i>				
CH	25	98.74	0.22	0.6
CL	24	88.41	0.52	1.4
ML	25	99.00	0.18	0.5
SP	25	2.647	0.60	1.7

<sup>A</sup>See footnotes in the Table 1.

perform a minimum of three replicate tests. Results of two properly conducted tests performed by the same operator on the same material, using the same equipment, and in the shortest practical period of time should not differ by more than the single-operator d2s limits shown in Table 1, Column 5. For definition of d2s see Footnote C in Table 2. Results of two properly conducted tests performed by different operators and on different days should not differ by more than the multilaboratory d2s limits shown in Table 1, Column 5.

10.1.2 In the ASTM Reference Soils and Testing Program, many of the laboratories performed only a single test on each soil type. This is common practice in the design and construction industry. The data for each soil type in Table 2 are based upon the first test results from the triplicate test laboratories and the single test results from the other laboratories. Results of two properly conducted tests performed by two different laboratories with different operators using different equipment and on different days should not vary by more than the d2s

**D1140 – 00 (2006)**

limits shown in **Table 2**, Column 5. The results in **Table 1** and **Table 2** are dissimilar because the data sets are different.

10.1.3 **Table 1** presents a rigorous interpretation of triplicate test data in accordance with Practice **E691** from pre-qualified laboratories. **Table 2** is derived from test data that represents common practice.

10.1.4 *Soil Types*—Based on the multilaboratory test results, the soils used in the program are described below in accordance with Practice **D2487**. In addition, the local names of the soils are given.

CH—Fat clay, CH, 99 % fines, LL=60, PI=39, grayish brown, soil had been air dried and pulverized. Local name—Vicksburg Buckshot Clay  
 CL—Lean clay, CL, 89 % fines, LL=33, PI=13, gray, soil had been air dried and pulverized. Local name—Annapolis Clay  
 ML—Silt, ML, 99 % fines, LL=27, PI=4, light brown, soil had been air dried and pulverized. Local name—Vicksburg Silt  
 SP—Poorly graded sand; SP, 20 % coarse sand, 48 % medium sand, 30 % fine sand, 2 % fines, yellowish brown. Local name—Frederick sand

## 11. Keywords

11.1 fines; particle sizes; sieve analysis; washing

*ASTM International takes no position respecting the validity of any patent rights asserted in connection with any item mentioned in this standard. Users of this standard are expressly advised that determination of the validity of any such patent rights, and the risk of infringement of such rights, are entirely their own responsibility.*

*This standard is subject to revision at any time by the responsible technical committee and must be reviewed every five years and if not revised, either reapproved or withdrawn. Your comments are invited either for revision of this standard or for additional standards and should be addressed to ASTM International Headquarters. Your comments will receive careful consideration at a meeting of the responsible technical committee, which you may attend. If you feel that your comments have not received a fair hearing you should make your views known to the ASTM Committee on Standards, at the address shown below.*

*This standard is copyrighted by ASTM International, 100 Barr Harbor Drive, PO Box C700, West Conshohocken, PA 19428-2959, United States. Individual reprints (single or multiple copies) of this standard may be obtained by contacting ASTM at the above address or at 610-832-9585 (phone), 610-832-9555 (fax), or service@astm.org (e-mail); or through the ASTM website (www.astm.org). Permission rights to photocopy the standard may also be secured from the ASTM website (www.astm.org/COPYRIGHT/).*



**APPENDIX E**

**ASTM Standard D2487  
Classification of Soils for Engineering Purposes  
(Unified Soil Classification System)**





Designation: D2487 – 11

# Standard Practice for Classification of Soils for Engineering Purposes (Unified Soil Classification System)<sup>1</sup>

This standard is issued under the fixed designation D2487; the number immediately following the designation indicates the year of original adoption or, in the case of revision, the year of last revision. A number in parentheses indicates the year of last reapproval. A superscript epsilon ( $\epsilon$ ) indicates an editorial change since the last revision or reapproval.

*This standard has been approved for use by agencies of the Department of Defense.*

## 1. Scope\*

1.1 This practice describes a system for classifying mineral and organo-mineral soils for engineering purposes based on laboratory determination of particle-size characteristics, liquid limit, and plasticity index and shall be used when precise classification is required.

NOTE 1—Use of this standard will result in a single classification group symbol and group name except when a soil contains 5 to 12 % fines or when the plot of the liquid limit and plasticity index values falls into the crosshatched area of the plasticity chart. In these two cases, a dual symbol is used, for example, GP-GM, CL-ML. When the laboratory test results indicate that the soil is close to another soil classification group, the borderline condition can be indicated with two symbols separated by a slash. The first symbol should be the one based on this standard, for example, CL/CH, GM/SM, SC/CL. Borderline symbols are particularly useful when the liquid limit value of clayey soils is close to 50. These soils can have expansive characteristics and the use of a borderline symbol (CL/CH, CH/CL) will alert the user of the assigned classifications of expansive potential.

1.2 The group symbol portion of this system is based on laboratory tests performed on the portion of a soil sample passing the 3-in. (75-mm) sieve (see Specification E11).

1.3 As a classification system, this standard is limited to naturally occurring soils.

NOTE 2—The group names and symbols used in this test method may be used as a descriptive system applied to such materials as shale, claystone, shells, crushed rock, etc. See Appendix X2.

1.4 This standard is for qualitative application only.

NOTE 3—When quantitative information is required for detailed designs of important structures, this test method must be supplemented by laboratory tests or other quantitative data to determine performance characteristics under expected field conditions.

1.5 This standard is the ASTM version of the Unified Soil Classification System. The basis for the classification scheme is the Airfield Classification System developed by A. Casa-

grande in the early 1940s.<sup>2</sup> It became known as the Unified Soil Classification System when several U.S. Government Agencies adopted a modified version of the Airfield System in 1952.

1.6 *This standard does not purport to address all of the safety concerns, if any, associated with its use. It is the responsibility of the user of this standard to establish appropriate safety and health practices and determine the applicability of regulatory limitations prior to use.*

1.7 *This practice offers a set of instructions for performing one or more specific operations. This document cannot replace education or experience and should be used in conjunction with professional judgment. Not all aspects of this practice may be applicable in all circumstances. This ASTM standard is not intended to represent or replace the standard of care by which the adequacy of a given professional service must be judged, nor should this document be applied without consideration of a project's many unique aspects. The word "Standard" in the title of this document means only that the document has been approved through the ASTM consensus process.*

## 2. Referenced Documents

### 2.1 ASTM Standards:<sup>3</sup>

[C117 Test Method for Materials Finer than 75- \$\mu\$ m \(No. 200\) Sieve in Mineral Aggregates by Washing](#)

[C136 Test Method for Sieve Analysis of Fine and Coarse Aggregates](#)

[C702 Practice for Reducing Samples of Aggregate to Testing Size](#)

[D420 Guide to Site Characterization for Engineering Design and Construction Purposes \(Withdrawn 2011\)<sup>4</sup>](#)

[D422 Test Method for Particle-Size Analysis of Soils](#)

[D653 Terminology Relating to Soil, Rock, and Contained Fluids](#)

<sup>2</sup> Casagrande, A., "Classification and Identification of Soils," *Transactions, ASCE*, 1948, p. 901.

<sup>3</sup> For referenced ASTM standards, visit the ASTM website, [www.astm.org](http://www.astm.org), or contact ASTM Customer Service at [service@astm.org](mailto:service@astm.org). For *Annual Book of ASTM Standards* volume information, refer to the standard's Document Summary page on the ASTM website.

<sup>4</sup> The last approved version of this historical standard is referenced on [www.astm.org](http://www.astm.org).

<sup>1</sup> This practice is under the jurisdiction of ASTM Committee D18 on Soil and Rock and is the direct responsibility of Subcommittee D18.07 on Identification and Classification of Soils.

Current edition approved May 1, 2011. Published June 2011. Originally approved in 1966. Last previous edition approved in 2010 as D2487 – 10. DOI: 10.1520/D2487-11.

\*A Summary of Changes section appears at the end of this standard

- D1140** Test Methods for Amount of Material in Soils Finer than No. 200 (75- $\mu$ m) Sieve
- D2216** Test Methods for Laboratory Determination of Water (Moisture) Content of Soil and Rock by Mass
- D2488** Practice for Description and Identification of Soils (Visual-Manual Procedure)
- D3740** Practice for Minimum Requirements for Agencies Engaged in Testing and/or Inspection of Soil and Rock as Used in Engineering Design and Construction
- D4083** Practice for Description of Frozen Soils (Visual-Manual Procedure)
- D4318** Test Methods for Liquid Limit, Plastic Limit, and Plasticity Index of Soils
- D4427** Classification of Peat Samples by Laboratory Testing
- D6913** Test Methods for Particle-Size Distribution (Gradation) of Soils Using Sieve Analysis
- E11** Specification for Woven Wire Test Sieve Cloth and Test Sieves

### 3. Terminology

#### 3.1 Definitions:

3.1.1 Except as listed below, all definitions are in accordance with Terminology **D653**.

NOTE 4—For particles retained on a 3-in. (75-mm) U.S. standard sieve, the following definitions are suggested:

*Cobbles*—particles of rock that will pass a 12-in. (300-mm) square opening and be retained on a 3-in. (75-mm) U.S. standard sieve, and

*Boulders*—particles of rock that will not pass a 12-in. (300-mm) square opening.

3.1.2 *clay*—soil passing a No. 200 (75- $\mu$ m) U.S. standard sieve that can be made to exhibit plasticity (putty-like properties) within a range of water contents and that exhibits considerable strength when air dry. For classification, a clay is a fine-grained soil, or the fine-grained portion of a soil, with a plasticity index equal to or greater than 4, and the plot of plasticity index versus liquid limit falls on or above the “A” line.

3.1.3 *gravel*—particles of rock that will pass a 3-in. (75-mm) sieve and be retained on a No. 4 (4.75-mm) U.S. standard sieve with the following subdivisions:

*Coarse*—passes 3-in. (75-mm) sieve and retained on  $\frac{3}{4}$ -in. (19-mm) sieve, and

*Fine*—passes  $\frac{3}{4}$ -in. (19-mm) sieve and retained on No. 4 (4.75-mm) sieve.

3.1.4 *organic clay*—a clay with sufficient organic content to influence the soil properties. For classification, an organic clay is a soil that would be classified as a clay except that its liquid limit value after oven drying is less than 75 % of its liquid limit value before oven drying.

3.1.5 *organic silt*—a silt with sufficient organic content to influence the soil properties. For classification, an organic silt is a soil that would be classified as a silt except that its liquid limit value after oven drying is less than 75 % of its liquid limit value before oven drying.

3.1.6 *peat*—a soil composed of vegetable tissue in various stages of decomposition usually with an organic odor, a dark-brown to black color, a spongy consistency, and a texture ranging from fibrous to amorphous.

3.1.7 *sand*—particles of rock that will pass a No. 4 (4.75-mm) sieve and be retained on a No. 200 (75- $\mu$ m) U.S. standard sieve with the following subdivisions:

*Coarse*—passes No. 4 (4.75-mm) sieve and retained on No. 10 (2.00-mm) sieve,

*Medium*—passes No. 10 (2.00-mm) sieve and retained on No. 40 (425- $\mu$ m) sieve, and

*Fine*—passes No. 40 (425- $\mu$ m) sieve and retained on No. 200 (75- $\mu$ m) sieve.

3.1.8 *silt*—soil passing a No. 200 (75- $\mu$ m) U.S. standard sieve that is nonplastic or very slightly plastic and that exhibits little or no strength when air dry. For classification, a silt is a fine-grained soil, or the fine-grained portion of a soil, with a plasticity index less than 4 or if the plot of plasticity index versus liquid limit falls below the “A” line.

#### 3.2 Definitions of Terms Specific to This Standard:

3.2.1 *coefficient of curvature,  $C_c$* —the ratio  $(D_{30})^2 / (D_{10} \times D_{60})$ , where  $D_{60}$ ,  $D_{30}$ , and  $D_{10}$  are the particle sizes corresponding to 60, 30, and 10 % finer on the cumulative particle-size distribution curve, respectively.

3.2.2 *coefficient of uniformity,  $C_u$* —the ratio  $D_{60}/D_{10}$ , where  $D_{60}$  and  $D_{10}$  are the particle diameters corresponding to 60 and 10 % finer on the cumulative particle-size distribution curve, respectively.

### 4. Summary

4.1 As illustrated in **Table 1**, this classification system identifies three major soil divisions: coarse-grained soils, fine-grained soils, and highly organic soils. These three divisions are further subdivided into a total of 15 basic soil groups.

4.2 Based on the results of visual observations and prescribed laboratory tests, a soil is catalogued according to the basic soil groups, assigned a group symbol(s) and name, and thereby classified. The flow charts, Fig. 1 for fine-grained soils, and Fig. 3 for coarse-grained soils, can be used to assign the appropriate group symbol(s) and name.

### 5. Significance and Use

5.1 This standard classifies soils from any geographic location into categories representing the results of prescribed laboratory tests to determine the particle-size characteristics, the liquid limit, and the plasticity index.

5.2 The assigning of a group name and symbol(s) along with the descriptive information required in Practice **D2488** can be used to describe a soil to aid in the evaluation of its significant properties for engineering use.

5.3 The various groupings of this classification system have been devised to correlate in a general way with the engineering behavior of soils. This standard provides a useful first step in any field or laboratory investigation for geotechnical engineering purposes.

5.4 This standard may also be used as an aid in training personnel in the use of Practice **D2488**.

5.5 This standard may be used in combination with Practice **D4083** when working with frozen soils.



TABLE 1 Soil Classification Chart

Criteria for Assigning Group Symbols and Group Names Using Laboratory Tests <sup>A</sup>				Soil Classification		
				Group Symbol	Group Name <sup>B</sup>	
COARSE-GRAINED SOILS	Gravels (More than 50 % of coarse fraction retained on No. 4 sieve)	Clean Gravels (Less than 5 % fines <sup>C</sup> )	$Cu \geq 4$ and $1 \leq Cc \leq 3^D$	GW	Well-graded gravel <sup>E</sup>	
			$Cu < 4$ and/or $[Cc < 1 \text{ or } Cc > 3]^D$	GP	Poorly graded gravel <sup>E</sup>	
		Gravels with Fines (More than 12 % fines <sup>C</sup> )	Fines classify as ML or MH	GM	Silty gravel <sup>E,F,G</sup>	
	More than 50 % retained on No. 200 sieve		Fines classify as CL or CH	GC	Clayey gravel <sup>E,F,G</sup>	
		Sands (50 % or more of coarse fraction passes No. 4 sieve)	Clean Sands (Less than 5 % fines <sup>H</sup> )	$Cu \geq 6$ and $1 \leq Cc \leq 3^D$	SW	Well-graded sand <sup>I</sup>
				$Cu < 6$ and/or $[Cc < 1 \text{ or } Cc > 3]^D$	SP	Poorly graded sand <sup>I</sup>
	Sands with Fines (More than 12 % fines <sup>H</sup> )	Fines classify as ML or MH	SM	Silty sand <sup>F,G,I</sup>		
FINE-GRAINED SOILS	Silt and Clays	inorganic	$PI > 7$ and plots on or above "A" line <sup>J</sup>	CL	Lean clay <sup>K,L,M</sup>	
			$PI < 4$ or plots below "A" line <sup>J</sup>	ML	Silt <sup>K,L,M</sup>	
		organic	Liquid limit – oven dried <sub>Liquid&amp;#10</sub> < 0.75	OL	Organic clay <sup>K,L,M,N</sup> Organic silt <sup>K,L,M,O</sup>	
	50 % or more passes the No. 200 sieve	Silt and Clays	inorganic	$PI$ plots on or above "A" line	CH	Fat clay <sup>K,L,M</sup>
				$PI$ plots below "A" line	MH	Elastic silt <sup>K,L,M</sup>
			organic	Liquid limit – oven dried <sub>Liquid&amp;#10</sub> < 0.75	OH	Organic clay <sup>K,L,M,P</sup> Organic silt <sup>K,L,M,Q</sup>
HIGHLY ORGANIC SOILS	Primarily organic matter, dark in color, and organic odor		PT	Peat		

<sup>A</sup> Based on the material passing the 3-in. (75-mm) sieve.

<sup>B</sup> If field sample contained cobbles or boulders, or both, add "with cobbles or boulders, or both" to group name.

<sup>C</sup> Gravels with 5 to 12 % fines require dual symbols:

- GW-GM well-graded gravel with silt
- GW-GC well-graded gravel with clay
- GP-GM poorly graded gravel with silt
- GP-GC poorly graded gravel with clay

$$^D Cu = D_{60}/D_{10} \quad Cc = \frac{(D_{30})^2}{D_{10} \times D_{60}}$$

<sup>E</sup> If soil contains  $\geq 15$  % sand, add "with sand" to group name.

<sup>F</sup> If fines classify as CL-ML, use dual symbol GC-GM, or SC-SM.

<sup>G</sup> If fines are organic, add "with organic fines" to group name.

<sup>H</sup> Sands with 5 to 12 % fines require dual symbols:

- SW-SM well-graded sand with silt
- SW-SC well-graded sand with clay
- SP-SM poorly graded sand with silt
- SP-SC poorly graded sand with clay

<sup>I</sup> If soil contains  $\geq 15$  % gravel, add "with gravel" to group name.

<sup>J</sup> If Atterberg limits plot in hatched area, soil is a CL-ML, silty clay.

<sup>K</sup> If soil contains 15 to <30 % plus No. 200, add "with sand" or "with gravel," whichever is predominant.

<sup>L</sup> If soil contains  $\geq 30$  % plus No. 200, predominantly sand, add "sand" to group name.

<sup>M</sup> If soil contains  $\geq 30$  % plus No. 200, predominantly gravel, add "gravelly" to group name.

<sup>N</sup>  $PI \geq 4$  and plots on or above "A" line.

<sup>O</sup>  $PI < 4$  or plots below "A" line.

<sup>P</sup>  $PI$  plots on or above "A" line.

<sup>Q</sup>  $PI$  plots below "A" line.

NOTE 5—Notwithstanding the statements on precision and bias contained in this standard: The precision of this test method is dependent on the competence of the personnel performing it and the suitability of the equipment and facilities used. Agencies that meet the criteria of Practice D3740 are generally considered capable of competent and objective testing. Users of this test method are cautioned that compliance with Practice D3740 does not in itself assure reliable testing. Reliable testing depends on several factors; Practice D3740 provides a means for evaluating some of those factors.

## 6. Apparatus

6.1 In addition to the apparatus that may be required for obtaining and preparing the samples and conducting the

prescribed laboratory tests, a plasticity chart, similar to Fig. 4, and a cumulative particle-size distribution curve, similar to Fig. 5, are required.

NOTE 6—The "U" line shown on Fig. 4 has been empirically determined to be the approximate "upper limit" for natural soils. It is a good check against erroneous data, and any test results that plot above or to the left of it should be verified.

## 7. Sampling

7.1 Samples shall be obtained and identified in accordance with a method or methods, recommended in Guide D420 or by other accepted procedures.



FIG. 1 Flow Chart for Classifying Fine-Grained Soil (50 % or More Passes No. 200 Sieve)

7.2 Test Methods D6913 provides guidance on selecting size of specimen. Two test methods are provided in this standard. The methods differ in the significant digits recorded and the size of the specimen (mass) required. The method to be used may be specified by the requesting authority; otherwise Method A shall be performed. Whenever possible, the field samples should have weights two to four times larger than shown.

7.3 If the field sample or test specimen is smaller than the minimum recommended amount, the report shall include an appropriate remark.

## 8. Classification of Peat

8.1 A sample composed primarily of vegetable tissue in various stages of decomposition and has a fibrous to amorphous texture, a dark-brown to black color, and an organic odor should be designated as a highly organic soil and shall be classified as peat, PT, and not subjected to the classification procedures described hereafter.

8.2 If desired, classification of type of peat can be performed in accordance with Classification D4427.

## 9. Preparation for Classification

9.1 Before a soil can be classified according to this standard, generally the particle-size distribution of the minus 3-in. (75-mm) material and the plasticity characteristics of the minus

No. 40 (425- $\mu$ m) sieve material must be determined. See 9.8 for the specific required tests.

9.2 The preparation of the soil specimen(s) and the testing for particle-size distribution and liquid limit and plasticity index shall be in accordance with accepted standard procedures. Two procedures for preparation of the soil specimens for testing for soil classification purposes are given in Appendixes X3 and X4. Appendix X3 describes the wet preparation method and is the preferred method for cohesive soils that have never dried out and for organic soils.

9.3 When reporting soil classifications determined by this standard, the preparation and test procedures used shall be reported or referenced.

9.4 Although the test procedure used in determining the particle-size distribution or other considerations may require a hydrometer analysis of the material, a hydrometer analysis is not necessary for soil classification.

9.5 The percentage (by dry weight) of any plus 3-in. (75-mm) material must be determined and reported as auxiliary information.

9.6 The maximum particle size shall be determined (measured or estimated) and reported as auxiliary information.

9.7 When the cumulative particle-size distribution is required, a set of sieves shall be used which include the





following sizes (with the largest size commensurate with the maximum particle size) with other sieve sizes as needed or required to define the particle-size distribution:

3-in. (75-mm)  
 ¾-in. (19.0-mm)  
 No. 4 (4.75-mm)  
 No. 10 (2.00-mm)  
 No. 40 (425-µm)  
 No. 200 (75-µm)

9.8 The tests required to be performed in preparation for classification are as follows:

9.8.1 For soils estimated to contain less than 5 % fines, a plot of the cumulative particle-size distribution curve of the fraction coarser than the No. 200 (75-µm) sieve is required. A semi-log plot of percent passing versus particle-size or sieve size/sieve number is plotted as shown in Fig. 5.

9.8.2 For soils estimated to contain 5 to 15 % fines, a cumulative particle-size distribution curve, as described in 9.8.1, is required, and the liquid limit and plasticity index are required.

9.8.2.1 If sufficient material is not available to determine the liquid limit and plasticity index, the fines should be estimated to be either silty or clayey using the procedures described in Practice D2488 and so noted in the report.

9.8.3 For soils estimated to contain 15 % or more fines, a determination of the percent fines, percent sand, and percent gravel is required, and the liquid limit and plasticity index are required. For soils estimated to contain 90 % fines or more, the percent fines, percent sand, and percent gravel may be estimated using the procedures described in Practice D2488 and so noted in the report.

## 10. Preliminary Classification Procedure

10.1 Class the soil as fine-grained if 50 % or more by dry weight of the test specimen passes the No. 200 (75-µm) sieve and follow Section 3.1.3.

10.2 Class the soil as coarse-grained if more than 50 % by dry weight of the test specimen is retained on the No. 200 (75-µm) sieve and follow Section 12.

## 11. Procedure for Classification of Fine-Grained Soils

(50 % or more by dry weight passing the No. 200 (75-µm) sieve)

11.1 The soil is an inorganic clay if the position of the plasticity index versus liquid limit plot, Fig. 4, falls on or above the “A” line, the plasticity index is greater than 4, and the presence of organic matter does not influence the liquid limit as determined in 11.3.2.

NOTE 7—The plasticity index and liquid limit are determined on the minus No. 40 (425 µm) sieve material.

11.1.1 Classify the soil as a *lean clay*, CL, if the liquid limit is less than 50. See area identified as CL on Fig. 4.

11.1.2 Classify the soil as a *fat clay*, CH, if the liquid limit is 50 or greater. See area identified as CH on Fig. 4.

NOTE 8—In cases where the liquid limit exceeds 110 or the plasticity index exceeds 60, the plasticity chart may be expanded by maintaining the same scale on both axes and extending the “A” line at the indicated slope.

11.1.3 Classify the soil as a *silty clay*, CL-ML, if the position of the plasticity index versus liquid limit plot falls on or above the “A” line and the plasticity index is in the range of 4 to 7. See area identified as CL-ML on Fig. 4.

11.2 The soil is an inorganic silt if the position of the plasticity index versus liquid limit plot, Fig. 4, falls below the “A” line or the plasticity index is less than 4, and presence of organic matter does not influence the liquid limit as determined in 11.3.2.

11.2.1 Classify the soil as a *silt*, ML, if the liquid limit is less than 50. See area identified as ML on Fig. 4.

11.2.2 Classify the soil as an *elastic silt*, MH, if the liquid limit is 50 or greater. See area identified as MH on Fig. 4.

11.3 The soil is an organic silt or clay if organic matter is present in sufficient amounts to influence the liquid limit as determined in 11.3.2.

11.3.1 If the soil has a dark color and an organic odor when moist and warm, a second liquid limit test shall be performed on a test specimen which has been oven dried at  $110 \pm 5^\circ\text{C}$  to a constant weight, typically over night.

11.3.2 The soil is an organic silt or organic clay if the liquid limit after oven drying is less than 75 % of the liquid limit of the original specimen determined before oven drying.

11.3.3 Classify the soil as an *organic silt* or *organic clay*, OL, if the liquid limit (not oven dried) is less than 50 %. Classify the soil as an *organic silt*, OL, if the plasticity index is less than 4, or the position of the plasticity index versus liquid limit plot falls below the “A” line. Classify the soil as an *organic clay*, OL, if the plasticity index is 4 or greater and the position of the plasticity index versus liquid limit plot falls on or above the “A” line. See area identified as OL (or CL-ML) on Fig. 4.

11.3.4 Classify the soil as an *organic clay* or *organic silt*, OH, if the liquid limit (not oven dried) is 50 or greater. Classify the soil as an *organic silt*, OH, if the position of the plasticity index versus liquid limit plot falls below the “A” line. Classify the soil as an *organic clay*, OH, if the position of the plasticity index versus liquid-limit plot falls on or above the “A” line. See area identified as OH on Fig. 4.

11.4 If less than 30 % but 15 % or more of the test specimen is retained on the No. 200 (75-µm) sieve, the words “with sand” or “with gravel” (whichever is predominant) shall be added to the group name. For example, lean clay with sand, CL; silt with gravel, ML. If the percent of sand is equal to the percent of gravel, use “with sand.”

11.5 If 30 % or more of the test specimen is retained on the No. 200 (75-µm) sieve, the words “sandy” or “gravelly” shall be added to the group name. Add the word “sandy” if 30 % or more of the test specimen is retained on the No. 200 (75-µm) sieve and the coarse-grained portion is predominantly sand. Add the word “gravelly” if 30 % or more of the test specimen is retained on the No. 200 (75-µm) sieve and the coarse-grained portion is predominantly gravel. For example, sandy lean clay,

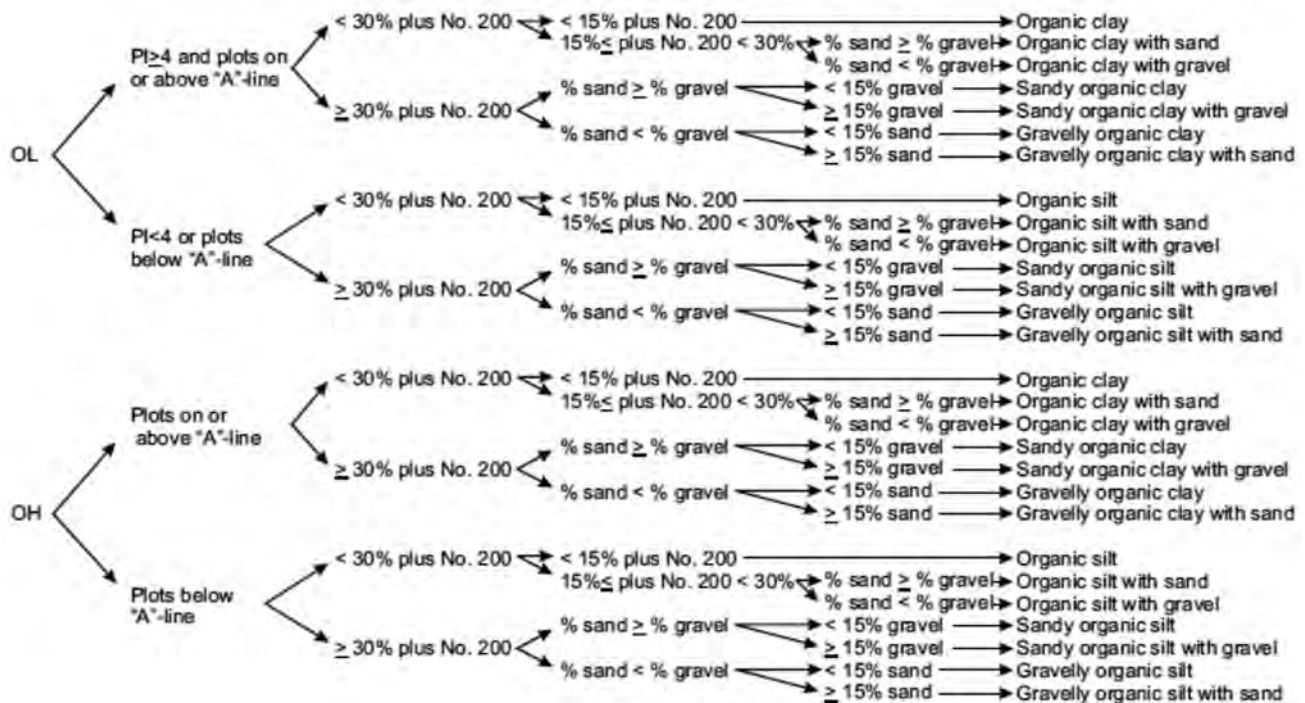

FIG. 2 Flow Chart for Classifying Organic Fine-Grained Soil (50 % or More Passes No. 200 Sieve)

CL; gravelly fat clay, CH; sandy silt, ML. If the percent of sand is equal to the percent of gravel, use “sandy.”

## 12. Procedure for Classification of Coarse-Grained Soils (more than 50 % retained on the No. 200 (75- $\mu$ m) sieve)

12.1 Class the soil as gravel if more than 50 % of the coarse fraction [plus No. 200 (75- $\mu$ m) sieve] is retained on the No. 4 (4.75-mm) sieve.

12.2 Class the soil as sand if 50 % or more of the coarse fraction [plus No. 200 (75- $\mu$ m) sieve] passes the No. 4 (4.75-mm) sieve.

12.3 If 12 % or less of the test specimen passes the No. 200 (75- $\mu$ m) sieve, plot the cumulative particle-size distribution, Fig. 5, and compute the coefficient of uniformity,  $C_u$ , and coefficient of curvature,  $C_c$ , as given in Eqs 1 and 2.

$$C_u = D_{60}/D_{10} \quad (1)$$

$$C_c = (D_{30})^2/(D_{10} \times D_{60}) \quad (2)$$

where:

$D_{10}$ ,  $D_{30}$ , and  $D_{60}$  = the particle-size diameters corresponding to 10, 30, and 60 %, respectively, passing on the cumulative particle-size distribution curve, Fig. 5.

NOTE 9—It may be necessary to extrapolate the curve to obtain the  $D_{10}$  diameter.

12.3.1 If less than 5 % of the test specimen passes the No. 200 (75- $\mu$ m) sieve, classify the soil as a *well-graded gravel*, GW, or *well-graded sand*, SW, if  $C_u$  is greater than or equal to 4.0 for gravel or greater than 6.0 for sand, and  $C_c$  is at least 1.0 but not more than 3.0.

12.3.2 If less than 5 % of the test specimen passes the No. 200 (75- $\mu$ m) sieve, classify the soil as *poorly graded gravel*,

GP, or *poorly graded sand*, SP, if either the  $C_u$  or the  $C_c$  criteria for well-graded soils are not satisfied.

12.4 If more than 12 % of the test specimen passes the No. 200 (75- $\mu$ m) sieve, the soil shall be considered a coarse-grained soil with fines. The fines are determined to be either clayey or silty based on the plasticity index versus liquid limit plot on Fig. 4. (See 9.8.2.1 if insufficient material available for testing) (see Note 7).

12.4.1 Classify the soil as a *clayey gravel*, GC, or *clayey sand*, SC, if the fines are clayey, that is, the position of the plasticity index versus liquid limit plot, Fig. 4, falls on or above the “A” line and the plasticity index is greater than 7.

12.4.2 Classify the soil as a *silty gravel*, GM, or *silty sand*, SM, if the fines are silty, that is, the position of the plasticity index versus liquid limit plot, Fig. 4, falls below the “A” line or the plasticity index is less than 4.

12.4.3 If the fines plot as a silty clay, CL-ML, classify the soil as a *silty, clayey gravel*, GC-GM, if it is a gravel or a *silty, clayey sand*, SC-SM, if it is a sand.

12.5 If 5 to 12 % of the test specimen passes the No. 200 (75- $\mu$ m) sieve, give the soil a dual classification using two group symbols.

12.5.1 The first group symbol shall correspond to that for a gravel or sand having less than 5 % fines (GW, GP, SW, SP), and the second symbol shall correspond to a gravel or sand having more than 12 % fines (GC, GM, SC, SM).

12.5.2 The group name shall correspond to the first group symbol plus “with clay” or “with silt” to indicate the plasticity characteristics of the fines. For example, well-graded gravel with clay, GW-GC; poorly graded sand with silt, SP-SM (See 9.8.2.1 if insufficient material available for testing).



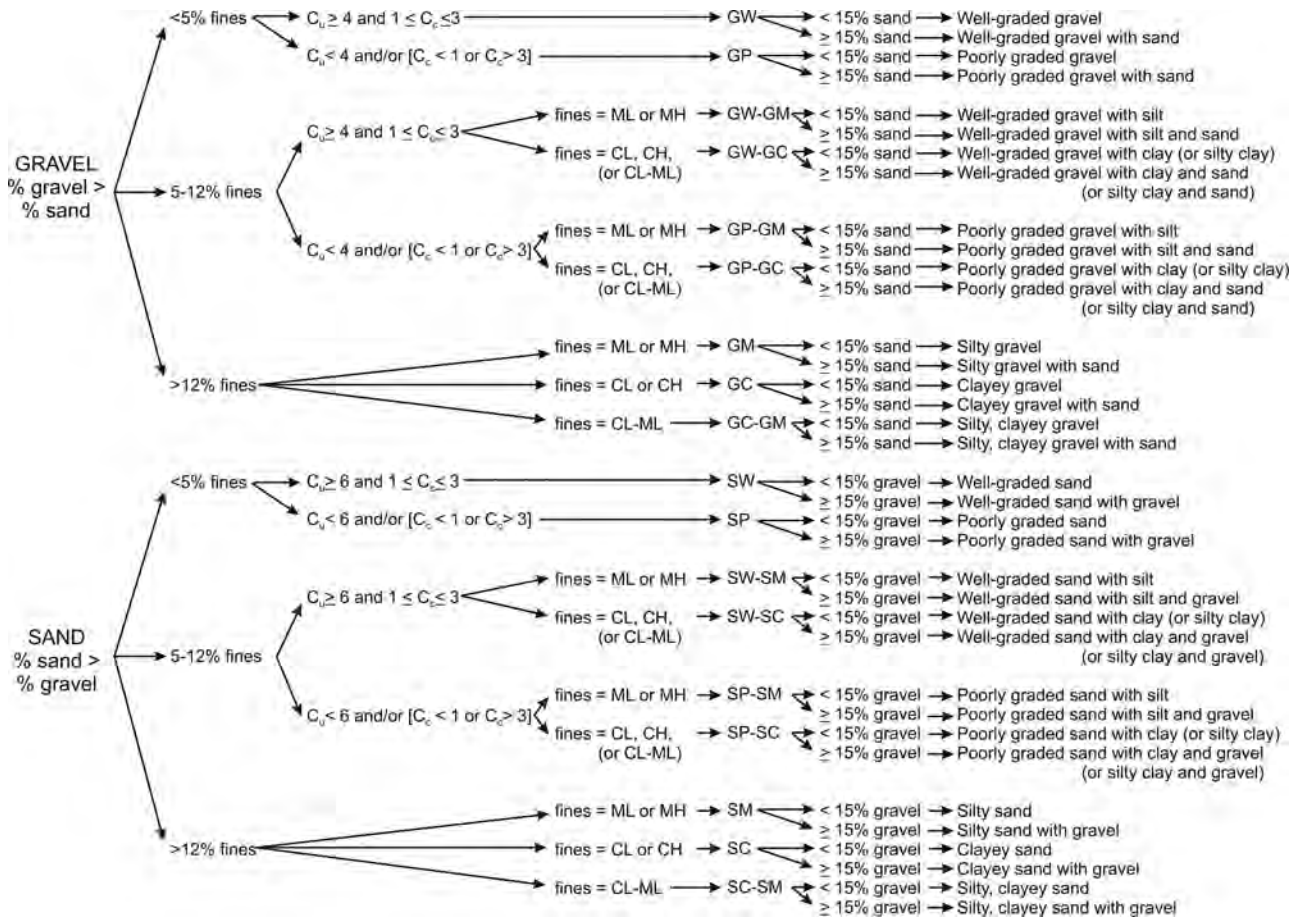

FIG. 3 Flow Chart for Classifying Coarse-Grained Soils (More Than 50 % Retained on No. 200 Sieve)

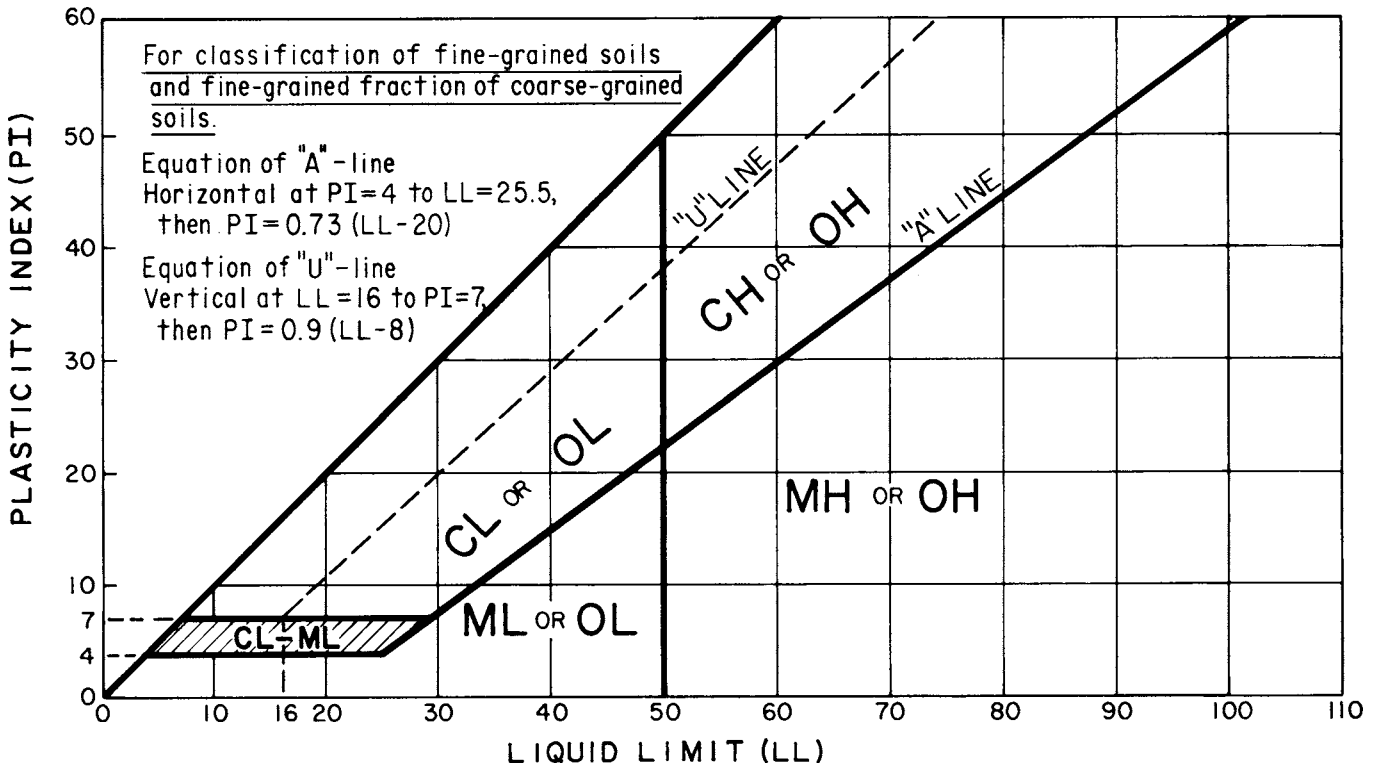

FIG. 4 Plasticity Chart



## SIEVE ANALYSIS

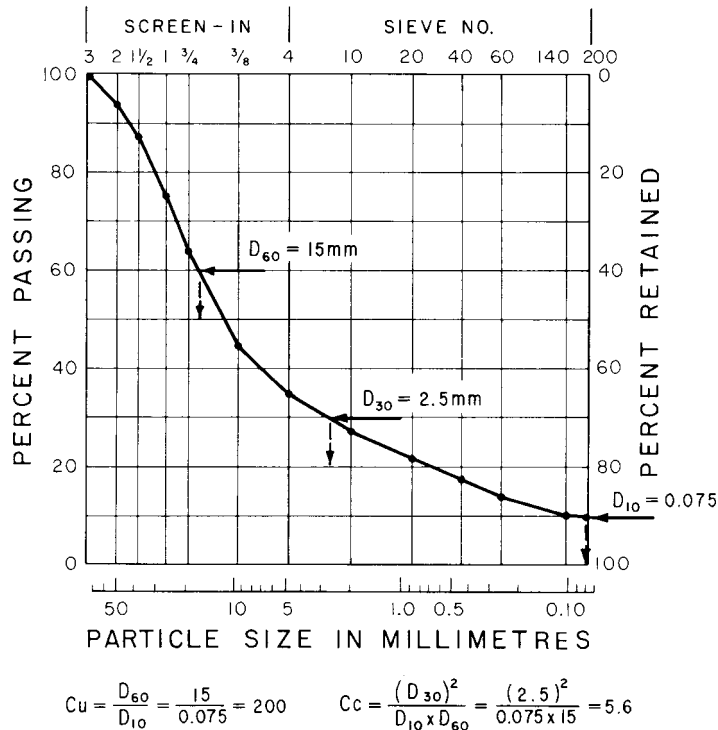

FIG. 5 Cumulative Particle-Size Plot

NOTE 10—If the fines plot as a *silty clay*, CL-ML, the second group symbol should be either GC or SC. For example, a poorly graded sand with 10 % fines, a liquid limit of 20, and a plasticity index of 6 would be classified as a poorly graded sand with silty clay, SP-SC.

12.6 If the specimen is predominantly sand or gravel but contains 15 % or more of the other coarse-grained constituent, the words “with gravel” or “with sand” shall be added to the group name. For example, poorly graded gravel with sand, clayey sand with gravel.

12.7 If the field sample contained any cobbles or boulders or both, the words “with cobbles,” or “with cobbles and boulders” shall be added to the group name. For example, silty gravel with cobbles, GM.

### 13. Report

13.1 The report should include the group name, group symbol, and the results of the laboratory tests. The particle-size distribution shall be given in terms of percent of gravel, sand, and fines. The plot of the cumulative particle-size distribution curve shall be reported if used in classifying the soil. Report appropriate descriptive information according to the procedures in Practice D2488. A local or commercial name or

geologic interpretation for the material may be added at the end of the descriptive information if identified as such. The test procedures used shall be referenced.

NOTE 11—*Example: Clayey Gravel with Sand and Cobbles (GC)*—46 % fine to coarse, hard, subrounded gravel; 30 % fine to coarse, hard, subrounded sand; 24 % clayey fines, LL = 38, PI = 19; weak reaction with HCl; original field sample had 4 % hard, subrounded cobbles; maximum dimension 150 mm.

In-Place Conditions—firm, homogeneous, dry, brown,  
Geologic Interpretation—alluvial fan.

NOTE 12—Other examples of soil descriptions are given in Appendix X1.

### 14. Precision and Bias

14.1 Criteria for acceptability depends on the precision and bias of Test Methods D422, D1140 and D4318.

### 15. Keywords

15.1 Atterberg limits; classification; clay; gradation; gravel; laboratory classification; organic soils; sand; silt; soil classification; soil tests



## APPENDIXES

## (Nonmandatory Information)

## X1. EXAMPLES OF DESCRIPTIONS USING SOIL CLASSIFICATION

X1.1 The following examples show how the information required in 13.1 can be reported. The appropriate descriptive information from Practice D2488 is included for illustrative purposes. The additional descriptive terms that would accompany the soil classification should be based on the intended use of the classification and the individual circumstances.

X1.1.1 *Well-Graded Gravel with Sand (GW)*—73 % fine to coarse, hard, subangular gravel; 23 % fine to coarse, hard, subangular sand; 4 % fines;  $C_c = 2.7$ ,  $C_u = 12.4$ .

X1.1.2 *Silty Sand with Gravel (SM)*—61 % predominantly fine sand; 23 % silty fines,  $LL = 33$ ,  $PI = 6$ ; 16 % fine, hard, subrounded gravel; no reaction with HCl; (field sample smaller than recommended). *In-Place Conditions*—Firm, stratified and contains lenses of silt 1 to 2 in. thick, moist, brown to gray; in-place density = 106 lb/ft<sup>3</sup> and in-place moisture = 9 %.

X1.1.3 *Organic Clay (OL)*—100 % fines,  $LL$  (not dried) = 32,  $LL$  (oven dried) = 21,  $PI$  (not dried) = 10; wet, dark brown, organic odor, weak reaction with HCl.

X1.1.4 *Silty Sand with Organic Fines (SM)*—74 % fine to coarse, hard, subangular reddish sand; 26 % organic and silty dark-brown fines,  $LL$  (not dried) = 37,  $LL$  (oven dried) = 26,  $PI$  (not dried) = 6, wet, weak reaction with HCl.

X1.1.5 *Poorly Graded Gravel with Silt, Sand, Cobbles and Boulders (GP-GM)*—78 % fine to coarse, hard, subrounded to subangular gravel; 16 % fine to coarse, hard, subrounded to subangular sand; 6 % silty (estimated) fines; moist, brown; no reaction with HCl; original field sample had 7 % hard, subrounded cobbles and 2 % hard, subrounded boulders with a maximum dimension of 18 in.

## X2. USING SOIL CLASSIFICATION AS A DESCRIPTIVE SYSTEM FOR SHALE, CLAYSTONE, SHELLS, SLAG, CRUSHED ROCK, ETC.

X2.1 The group names and symbols used in this standard may be used as a descriptive system applied to materials that exist in situ as shale, claystone, sandstone, siltstone, mudstone, etc., but convert to soils after field or laboratory processing (crushing, slaking, etc.).

X2.2 Materials such as shells, crushed rock, slag, etc., should be identified as such. However, the procedures used in this standard for describing the particle size and plasticity characteristics may be used in the description of the material. If desired, a classification in accordance with this standard may be assigned to aid in describing the material.

X2.3 If a classification is used, the group symbol(s) and group names should be placed in quotation marks or noted with some type of distinguishing symbol. See examples.

**X2.4 Examples of how soil classifications could be incorporated into a description system for materials that are not naturally occurring soils are as follows:**

X2.4.1 *Shale Chunks*—Retrieved as 2- to 4-in. pieces of shale from power auger hole, dry, brown, no reaction with HCl.

After laboratory processing by slaking in water for 24 h, material classified as “Sandy Lean Clay (CL)”—61 % clayey fines,  $LL = 37$ ,  $PI = 16$ ; 33 % fine to medium sand; 6 % gravel-size pieces of shale.

X2.4.2 *Crushed Sandstone*—Product of commercial crushing operation; “Poorly Graded Sand with Silt (SP-SM)”—91 % fine to medium sand; 9 % silty (estimated) fines; dry, reddish-brown, strong reaction with HCl.

X2.4.3 *Broken Shells*—65 % gravel-size broken shells; 31 % sand and sand-size shell pieces; 4 % fines;  $C_c = 2.4$ ,  $C_u = 1.9$ ; would be classified as “Poorly Graded Gravel with Sand (GP)”.

X2.4.4 *Crushed Rock*—Processed gravel and cobbles from Pit No. 7; “Poorly Graded Gravel (GP)”—89 % fine, hard, angular gravel-size particles; 11 % coarse, hard, angular sand-size particles, dry, tan; no reaction with HCl;  $C_c = 2.4$ ,  $C_u = 0.9$ .



### X3. PREPARATION AND TESTING FOR CLASSIFICATION PURPOSES BY THE WET METHOD

X3.1 This appendix describes the steps in preparing a soil sample for testing for purposes of soil classification using a wet-preparation procedure.

X3.2 Samples prepared in accordance with this procedure should contain as much of their natural water content as possible and every effort should be made during obtaining, preparing, and transporting the samples to maintain the natural moisture.

X3.3 The procedures to be followed in this standard assume that the field sample contains fines, sand, gravel, and plus 3-in. (75-mm) particles and the cumulative particle-size distribution plus the liquid limit and plasticity index values are required (see 9.8). Some of the following steps may be omitted when they are not applicable to the soil being tested.

X3.4 If the soil contains plus No. 200 (75- $\mu$ m) particles that would degrade during dry sieving, use a test procedure for determining the particle-size characteristics that prevents this degradation.

X3.5 Since this classification system is limited to the portion of a sample passing the 3-in. (75-mm) sieve, the plus 3-in. (75-mm) material shall be removed prior to the determination of the particle-size characteristics and the liquid limit and plasticity index.

#### X3.6 The portion of the field sample finer than the 3-in. (75-mm) sieve shall be obtained as follows:

X3.6.1 Separate the field sample into two fractions on a 3-in. (75-mm) sieve, being careful to maintain the natural water content in the minus 3-in. (75-mm) fraction. Any particles adhering to the plus 3-in. (75-mm) particles shall be brushed or wiped off and placed in the fraction passing the 3-in. (75-mm) sieve.

X3.6.2 Determine the air-dry or oven-dry weight of the fraction retained on the 3-in. (75-mm) sieve. Determine the total (wet) weight of the fraction passing the 3-in. (75-mm) sieve.

X3.6.3 Thoroughly mix the fraction passing the 3-in. (75-mm) sieve. Determine the water content, in accordance with Test Method D2216, of a representative specimen with a minimum dry weight as required in 7.2. Save the water-content specimen for determination of the particle-size analysis in accordance with X3.8.

X3.6.4 Compute the dry weight of the fraction passing the 3-in. (75-mm) sieve based on the water content and total (wet) weight. Compute the total dry weight of the sample and calculate the percentage of material retained on the 3-in. (75-mm) sieve.

#### X3.7 Determine the liquid limit and plasticity index as follows:

X3.7.1 If the soil disaggregates readily, mix on a clean, hard surface and select a representative sample by quartering in accordance with Practice C702.

X3.7.1.1 If the soil contains coarse-grained particles coated with and bound together by tough clayey material, take extreme care in obtaining a representative portion of the No. 40 (425- $\mu$ m) fraction. Typically, a larger portion than normal has to be selected, such as the minimum weights required in 7.2.

X3.7.1.2 To obtain a representative specimen of a basically cohesive soil, it may be advantageous to pass the soil through a  $\frac{3}{4}$ -in. (19-mm) sieve or other convenient size so the material can be more easily mixed and then quartered or split to obtain the representative specimen.

X3.7.2 Process the representative specimen in accordance with the Wet Preparation Method in Test Method D4318.

X3.7.3 Perform the liquid-limit test in accordance with Test Method D4318, except the soil shall not be air dried prior to the test.

X3.7.4 Perform the plastic-limit test in accordance with Test Method D4318, except the soil shall not be air dried prior to the test, and calculate the plasticity index.

#### X3.8 Determine the particle-size distribution as follows:

X3.8.1 If the water content of the fraction passing the 3-in. (75-mm) sieve was required (X3.6.3), use the water-content specimen for determining the particle-size distribution. Otherwise, select a representative specimen in accordance with Practice C702 with a minimum dry weight as required in 7.2.

X3.8.2 If the cumulative particle-size distribution including a hydrometer analysis is required, determine the particle-size distribution in accordance with Test Method D422. See 9.7 for the set of required sieves.

X3.8.3 If the cumulative particle-size distribution without a hydrometer analysis is required, determine the particle-size distribution in accordance with Test Method C136. See 9.7 for the set of required sieves. The specimen should be soaked until all clayey aggregations have softened and then washed in accordance with Test Method C117 prior to performing the particle-size distribution.

X3.8.4 If the cumulative particle-size distribution is not required, determine the percent fines, percent sand, and percent gravel in the specimen in accordance with Test Method C117, being sure to soak the specimen long enough to soften all clayey aggregations, followed by Test Method C136 using a nest of sieves which shall include a No. 4 (4.75-mm) sieve and a No. 200 (75- $\mu$ m) sieve.

X3.8.5 Calculate the percent fines, percent sand, and percent gravel in the minus 3-in. (75-mm) fraction for classification purposes.





#### X4. AIR-DRIED METHOD OF PREPARATION OF SOILS FOR TESTING FOR CLASSIFICATION PURPOSES

X4.1 This appendix describes the steps in preparing a soil sample for testing for purposes of soil classification when air-drying the soil before testing is specified or desired or when the natural moisture content is near that of an air-dried state.

X4.2 If the soil contains organic matter or mineral colloids that are irreversibly affected by air drying, the wet-preparation method as described in Appendix X3 should be used.

X4.3 Since this classification system is limited to the portion of a sample passing the 3-in. (75-mm) sieve, the plus 3-in. (75-mm) material shall be removed prior to the determination of the particle-size characteristics and the liquid limit and plasticity index.

##### X4.4 The portion of the field sample finer than the 3-in. (75-mm) sieve shall be obtained as follows:

X4.4.1 Air dry and weigh the field sample.

X4.4.2 Separate the field sample into two fractions on a 3-in. (75-mm) sieve.

X4.4.3 Weigh the two fractions and compute the percentage of the plus 3-in. (75-mm) material in the field sample.

X4.5 Determine the particle-size distribution and liquid limit and plasticity index as follows (see 9.8 for when these tests are required):

X4.5.1 Thoroughly mix the fraction passing the 3-in. (75-mm) sieve.

X4.5.2 If the cumulative particle-size distribution including a hydrometer analysis is required, determine the particle-size distribution in accordance with Test Method D422. See 9.7 for the set of sieves that is required.

X4.5.3 If the cumulative particle-size distribution without a hydrometer analysis is required, determine the particle-size distribution in accordance with Test Method D1140 followed by Test Method C136. See 9.7 for the set of sieves that is required.

X4.5.4 If the cumulative particle-size distribution is not required, determine the percent fines, percent sand, and percent gravel in the specimen in accordance with Test Method D1140 followed by Test Method C136 using a nest of sieves which shall include a No. 4 (4.75-mm) sieve and a No. 200 (75- $\mu$ m) sieve.

X4.5.5 If required, determine the liquid limit and the plasticity index of the test specimen in accordance with Test Method D4318.

#### X5. ABBREVIATED SOIL CLASSIFICATION SYMBOLS

X5.1 In some cases, because of lack of space, an abbreviated system may be useful to indicate the soil classification symbol and name. Examples of such cases would be graphical logs, databases, tables, etc.

X5.2 This abbreviated system is not a substitute for the full name and descriptive information but can be used in supplementary presentations when the complete description is referenced.

X5.3 The abbreviated system should consist of the soil classification symbol based on this standard with appropriate lower case letter prefixes and suffixes as:

Prefix	Suffix
s = sandy	s = with sand
g = gravelly	g = with gravel
	c = cobbles
	b = boulders

##### X5.4 The soil classification symbol is to be enclosed in parentheses. Some examples would be:

Group Symbol and Full Name	Abbreviated
CL, Sandy lean clay	s(CL)
SP-Sm, Poorly graded sand with silt and gravel	(SP-SM)g
GP, poorly graded gravel with sand, cobbles, and boulders	(GP)scb
ML, gravelly silt with sand and cobbles	g(ML)sc



D2487 – 11

## SUMMARY OF CHANGES

Committee D18 has identified the location of selected changes to this practice since the last issue, D2487–10, that may impact the use of this practice. (Approved May 1, 2011.)

(I) Deleted reference to Practice D2217 in 11.3.2 and X3.7.2.

*ASTM International takes no position respecting the validity of any patent rights asserted in connection with any item mentioned in this standard. Users of this standard are expressly advised that determination of the validity of any such patent rights, and the risk of infringement of such rights, are entirely their own responsibility.*

*This standard is subject to revision at any time by the responsible technical committee and must be reviewed every five years and if not revised, either reapproved or withdrawn. Your comments are invited either for revision of this standard or for additional standards and should be addressed to ASTM International Headquarters. Your comments will receive careful consideration at a meeting of the responsible technical committee, which you may attend. If you feel that your comments have not received a fair hearing you should make your views known to the ASTM Committee on Standards, at the address shown below.*

*This standard is copyrighted by ASTM International, 100 Barr Harbor Drive, PO Box C700, West Conshohocken, PA 19428-2959, United States. Individual reprints (single or multiple copies) of this standard may be obtained by contacting ASTM at the above address or at 610-832-9585 (phone), 610-832-9555 (fax), or service@astm.org (e-mail); or through the ASTM website (www.astm.org). Permission rights to photocopy the standard may also be secured from the ASTM website (www.astm.org/COPYRIGHT/).*





**APPENDIX F**

**ASTM Standard D4318  
Liquid Limit, Plastic Limit, and Plasticity Index of Soils**

Designation: D4318 – 10<sup>ε</sup>1

## Standard Test Methods for Liquid Limit, Plastic Limit, and Plasticity Index of Soils<sup>1</sup>

This standard is issued under the fixed designation D4318; the number immediately following the designation indicates the year of original adoption or, in the case of revision, the year of last revision. A number in parentheses indicates the year of last reapproval. A superscript epsilon ( $\epsilon$ ) indicates an editorial change since the last revision or reapproval.

*This standard has been approved for use by agencies of the U.S. Department of Defense.*

<sup>ε</sup>1 NOTE—Editorial corrections made throughout in January 2014.

### 1. Scope\*

1.1 These test methods cover the determination of the liquid limit, plastic limit, and the plasticity index of soils as defined in Section 3 on Terminology.

1.2 Two methods for preparing test specimens are provided as follows: *Wet preparation method*, as described in 10.1. *Dry preparation method*, as described in 10.2. The method to be used shall be specified by the requesting authority. If no method is specified, use the wet preparation method.

1.2.1 The liquid and plastic limits of many soils that have been allowed to dry before testing may be considerably different from values obtained on non-dried samples. If the liquid and plastic limits of soils are used to correlate or estimate the engineering behavior of soils in their natural moist state, samples should not be permitted to dry before testing unless data on dried samples are specifically desired.

1.3 Two methods for determining the liquid limit are provided as follows: *Method A*, Multipoint test as described in Sections 11 and 12. *Method B*, One-point test as described in Sections 13 and 14. The method to be used shall be specified by the requesting authority. If no method is specified, use Method A.

1.3.1 The multipoint liquid limit method is generally more precise than the one-point method. It is recommended that the multipoint method be used in cases where test results may be subject to dispute, or where greater precision is required.

1.3.2 Because the one-point method requires the operator to judge when the test specimen is approximately at its liquid limit, it is particularly not recommended for use by inexperienced operators.

1.3.3 The correlation on which the calculations of the one-point method are based may not be valid for certain soils, such as organic soils or soils from a marine environment. It is

strongly recommended that the liquid limit of these soils be determined by the multipoint method.

1.4 The plastic limit test is performed on material prepared for the liquid limit test.

1.5 The liquid limit and plastic limit of soils (along with the shrinkage limit) are often collectively referred to as the Atterberg limits. These limits distinguished the boundaries of the several consistency states of plastic soils.

1.6 The composition and concentration of soluble salts in a soil affect the values of the liquid and plastic limits as well as the water content values of soils (see Test Method D4542). Special consideration should therefore be given to soils from a marine environment or other sources where high soluble salt concentrations may be present. The degree to which the salts present in these soils are diluted or concentrated must be given careful consideration.

1.7 The methods described herein are performed only on that portion of a soil that passes the 425- $\mu\text{m}$  (No. 40) sieve. Therefore, the relative contribution of this portion of the soil to the properties of the sample as a whole must be considered when using these tests to evaluate properties of a soil.

1.8 The values stated in SI units are to be regarded as the standard, except as noted below. The values given in parentheses are for information only.

1.8.1 The standard units for the resilience tester covered in Annex A1 are inch-pound, not SI. The SI values given are for information only.

1.9 All observed and calculated values shall conform to the guidelines for significant digits and rounding established in Practice D6026.

1.9.1 For purposes of comparing a measured or calculated value(s) with specified limits, the measured or calculated value(s) shall be rounded to the nearest decimal or significant digits in the specified limits

1.9.2 The procedures used to specify how data are collected/recorded or calculated, in this standard are regarded as the industry standard. In addition, they are representative of the significant digits that generally should be retained. The procedures do not consider material variation, purpose for obtaining

<sup>1</sup> These test methods are under the jurisdiction of ASTM Committee D18 on Soil and Rock and are the direct responsibility of Subcommittee D18.03 on Texture, Plasticity and Density Characteristics of Soils.

Current edition approved Jan. 15, 2010. Published March 2010. Originally approved in 1983. Last previous edition approved in 2005 as D4318 – 05. DOI: 10.1520/D4318-10E01.

\*A Summary of Changes section appears at the end of this standard

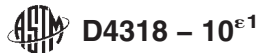

the data, special purpose studies, or any considerations for the user's objectives; and it is common practice to increase or reduce significant digits of reported data to be commensurate with these considerations. It is beyond the scope of this standard to consider significant digits used in analysis methods for engineering design.

1.10 *This standard does not purport to address all of the safety concerns, if any, associated with its use. It is the responsibility of the user of this standard to establish appropriate safety and health practices and determine the applicability of regulatory limitations prior to use.*

## 2. Referenced Documents

### 2.1 ASTM Standards:<sup>2</sup>

- [C702 Practice for Reducing Samples of Aggregate to Testing Size](#)
- [D75 Practice for Sampling Aggregates](#)
- [D420 Guide to Site Characterization for Engineering Design and Construction Purposes \(Withdrawn 2011\)<sup>3</sup>](#)
- [D653 Terminology Relating to Soil, Rock, and Contained Fluids](#)
- [D1241 Specification for Materials for Soil-Aggregate Subbase, Base, and Surface Courses](#)
- [D2216 Test Methods for Laboratory Determination of Water \(Moisture\) Content of Soil and Rock by Mass](#)
- [D2487 Practice for Classification of Soils for Engineering Purposes \(Unified Soil Classification System\)](#)
- [D3282 Practice for Classification of Soils and Soil-Aggregate Mixtures for Highway Construction Purposes](#)
- [D3740 Practice for Minimum Requirements for Agencies Engaged in Testing and/or Inspection of Soil and Rock as Used in Engineering Design and Construction](#)
- [D4542 Test Method for Pore Water Extraction and Determination of the Soluble Salt Content of Soils by Refractometer](#)
- [D4753 Guide for Evaluating, Selecting, and Specifying Balances and Standard Masses for Use in Soil, Rock, and Construction Materials Testing](#)
- [D6026 Practice for Using Significant Digits in Geotechnical Data](#)
- [E11 Specification for Woven Wire Test Sieve Cloth and Test Sieves](#)
- [E177 Practice for Use of the Terms Precision and Bias in ASTM Test Methods](#)
- [E691 Practice for Conducting an Interlaboratory Study to Determine the Precision of a Test Method](#)

## 3. Terminology

### 3.1 Definitions:

3.1.1 For common definitions of terms in this standard, refer to Terminology [D653](#).

<sup>2</sup> For referenced ASTM standards, visit the ASTM website, [www.astm.org](http://www.astm.org), or contact ASTM Customer Service at [service@astm.org](mailto:service@astm.org). For *Annual Book of ASTM Standards* volume information, refer to the standard's Document Summary page on the ASTM website.

<sup>3</sup> The last approved version of this historical standard is referenced on [www.astm.org](http://www.astm.org).

3.1.2 *Atterberg Limits*—Originally, six “limits of consistency” of fine-grained soils were defined by Albert Atterberg: the upper limit of viscous flow, the liquid limit, the sticky limit, the cohesion limit, the plastic limit, and the shrinkage limit. In current engineering usage, the term usually refers only to the liquid limit, plastic limit, and in some references, the shrinkage limit.

3.1.3 *consistency*—the relative ease with which a soil can be deformed.

3.1.4 *liquid limit (LL,  $w_L$ )*—the water content, in percent, of a soil at the arbitrarily defined boundary between the semi-liquid and plastic states.

3.1.4.1 *Discussion*—The undrained shear strength of soil at the liquid limit is considered to be approximately 2 kPa (0.28 psi).

3.1.5 *plastic limit (PL,  $w_p$ )*—the water content, in percent, of a soil at the boundary between the plastic and semi-solid states.

3.1.6 *plastic soil*—a soil which has a range of water content over which it exhibits plasticity and which will retain its shape on drying.

3.1.7 *plasticity index (PI)*—the range of water content over which a soil behaves plastically. Numerically, it is the difference between the liquid limit and the plastic limit.

3.1.8 *liquidity index*—the ratio, expressed as a percentage of (1) the water content of a soil minus its plastic limit, to (2) its plasticity index.

3.1.9 *activity number (A)*—the ratio of (1) the plasticity index of a soil to (2) the percent by mass of particles having an equivalent diameter smaller than 2  $\mu\text{m}$ .

## 4. Summary of Test Method

4.1 The specimen is processed to remove any material retained on a 425- $\mu\text{m}$  (No. 40) sieve. The liquid limit is determined by performing trials in which a portion of the specimen is spread in a brass cup, divided in two by a grooving tool, and then allowed to flow together from the shocks caused by repeatedly dropping the cup in a standard mechanical device. The multipoint liquid limit, Method A, requires three or more trials over a range of water contents to be performed and the data from the trials plotted or calculated to make a relationship from which the liquid limit is determined. The one-point liquid limit, Method B, uses the data from two trials at one water content multiplied by a correction factor to determine the liquid limit.

4.2 The plastic limit is determined by alternately pressing together and rolling into a 3.2-mm ( $1/8$ -in.) diameter thread a small portion of plastic soil until its water content is reduced to a point at which the thread crumbles and can no longer be pressed together and re-rolled. The water content of the soil at this point is reported as the plastic limit.

4.3 The plasticity index is calculated as the difference between the liquid limit and the plastic limit.

## 5. Significance and Use

5.1 These test methods are used as an integral part of several engineering classification systems to characterize the fine-grained fractions of soils (see Practices [D2487](#) and [D3282](#)) and

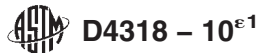

to specify the fine-grained fraction of construction materials (see Specification D1241). The liquid limit, plastic limit, and plasticity index of soils are also used extensively, either individually or together, with other soil properties to correlate with engineering behavior such as compressibility, hydraulic conductivity (permeability), compactibility, shrink-swell, and shear strength.

5.2 The liquid and plastic limits of a soil and its water content can be used to express its relative consistency or liquidity index. In addition, the plasticity index and the percentage finer than 2- $\mu$ m particle size can be used to determine its activity number.

5.3 These methods are sometimes used to evaluate the weathering characteristics of clay-shale materials. When subjected to repeated wetting and drying cycles, the liquid limits of these materials tend to increase. The amount of increase is considered to be a measure of a shale's susceptibility to weathering.

5.4 The liquid limit of a soil containing substantial amounts of organic matter decreases dramatically when the soil is oven-dried before testing. Comparison of the liquid limit of a sample before and after oven-drying can therefore be used as a qualitative measure of organic matter content of a soil (see Practice D2487).

NOTE 1—The quality of the result produced by this standard is dependent on the competence of the personnel performing it and the suitability of the equipment and facilities used. Agencies that meet the criteria of Practice D3740, generally, are considered capable of competent and objective testing/sampling/inspection/etc. Users of this standard are cautioned that compliance with Practice D3740 does not in itself assure reliable results. Reliable results depend on many factors; Practice D3740

provides a means of evaluating some of those factors.

6. Apparatus

6.1 *Liquid Limit Device*—A mechanical device consisting of a brass cup suspended from a carriage designed to control its drop onto the surface of a block of resilient material that serves as the base of the device. Fig. 1 shows the essential features and critical dimensions of the device. The device may be operated by either a hand crank or electric motor.

6.1.1 *Base*—A block of material having a resilience rebound of at least 77 % but no more than 90 %. Conduct resilience tests on the finished base with the feet attached. Details for measuring the resilience of the base are given in Annex A1.

6.1.2 *Rubber Feet*, supporting the base, designed to provide dynamic isolation of the base from the work surface.

6.1.3 *Cup*, brass, with a mass, including cup hanger, of 185 to 215 g.

6.1.4 *Cam*—Designed to raise the cup smoothly and continuously to its maximum height, over a distance of at least 180° of cam rotation, without developing an upward or downward velocity of the cup when the cam follower leaves the cam. (The preferred cam motion is a uniformly accelerated lift curve.)

NOTE 2—The cam and follower design in Fig. 1 is for uniformly accelerated (parabolic) motion after contact and assures that the cup has no velocity at drop off. Other cam designs also provide this feature and may be used. However, if the cam-follower lift pattern is not known, zero velocity at drop off can be assured by carefully filing or machining the cam and follower so that the cup height remains constant over the last 20 to 45° of cam rotation.

6.1.5 *Carriage*, constructed in a way that allows convenient but secure adjustment of the height-of-drop of the cup to 10

DIMENSIONS

LETTER	A <sup>Δ</sup>	B <sup>Δ</sup>	C <sup>Δ</sup>	E <sup>Δ</sup>	F	G	H	J <sup>Δ</sup>	K <sup>Δ</sup>	L <sup>Δ</sup>	M <sup>Δ</sup>
MM	54 ± 0.5	2 ± 0.1	27 ± 0.5	56 ± 2.0	32	10	16	60 ± 1.0	50 ± 2.0	150 ± 2.0	125 ± 2.0
LETTER	N	P	R	T	U <sup>Δ</sup>	V	W	Z			
MM	24	28	24	45	47 ± 1.0	3.8	13	6.5			

<sup>Δ</sup> ESSENTIAL DIMENSIONS

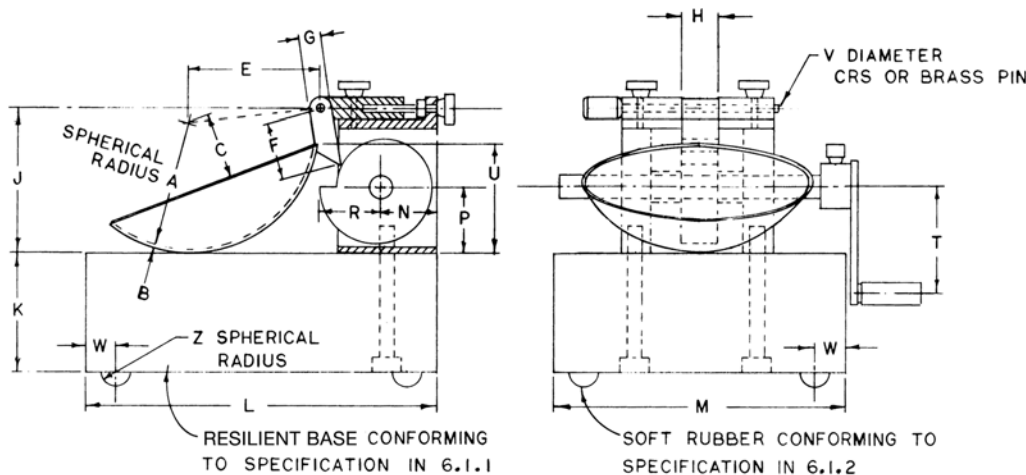

CAM ANGLE DEGREES	CAM RADIUS
0	0.742 R
30	0.753 R
60	0.764 R
90	0.773 R
120	0.784 R
150	0.796 R
180	0.818 R
210	0.854 R
240	0.901 R
270	0.945 R
300	0.974 R
330	0.995 R
360	1.000 R

FIG. 1 Hand-Operated Liquid Limit Device

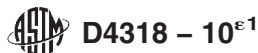

mm (0.394 in.), and designed such that the cup and cup hanger assembly is only attached to the carriage by means of a removable pin. See Fig. 2 for definition and determination of the height-of-drop of the cup.

6.1.6 *Motor Drive (Optional)*—As an alternative to the hand crank shown in Fig. 1, the device may be equipped with a motor to turn the cam. Such a motor must turn the cam at  $2 \pm 0.1$  revolutions per second and must be isolated from the rest of the device by rubber mounts or in some other way that prevents vibration from the motor being transmitted to the rest of the apparatus. It must be equipped with an ON-OFF switch and a means of conveniently positioning the cam for height-of-drop adjustments. The results obtained using a motor-driven device must not differ from those obtained using a manually operated device.

6.2 *Flat Grooving Tool*—A tool made of plastic or noncorroding-metal having the dimensions shown in Fig. 3. The design of the tool may vary as long as the essential dimensions are maintained. The tool may, but need not, incorporate the gauge for adjusting the height-of-drop of the liquid limit device.

NOTE 3—Prior to the adoption of this test method, a curved grooving tool was specified as part of the apparatus for performing the liquid limit test. The curved tool is not considered to be as accurate as the flat tool described in 6.2 since it does not control the depth of the soil in the liquid limit cup. However, there are some data which indicate that typically the liquid limit is slightly increased when the flat tool is used instead of the curved tool.

6.3 *Gauge*—A metal gauge block for adjusting the height-of-drop of the cup, having the dimensions shown in Fig. 4. The design of the tool may vary provided the gauge will rest securely on the base without being susceptible to rocking, and the edge which contacts the cup during adjustment is straight, at least 10 mm ( $\frac{3}{8}$  in.) wide, and without bevel or radius.

6.4 *Water Content Containers*—Small corrosion-resistant containers with snug-fitting lids for water content specimens. Aluminum or stainless steel cans 2.5 cm (1 in.) high by 5 cm (2 in.) in diameter are appropriate.

6.5 *Balance*, conforming to Guide D4753, Class GP1 (readability of 0.01 g).

6.6 *Mixing and Storage Container*—A container to mix the soil specimen (material) and store the prepared material.

During mixing and storage, the container shall not contaminate the material in any way, and prevent moisture loss during storage. A porcelain, glass, or plastic dish about 11.4 cm ( $4\frac{1}{2}$  in.) in diameter and a plastic bag large enough to enclose the dish and be folded over is adequate.

#### 6.7 Plastic Limit:

6.7.1 *Ground Glass Plate*—A ground glass plate of sufficient size for rolling plastic limit threads.

6.7.2 *Plastic Limit-Rolling Device (optional)*—A device made of acrylic conforming to the dimensions shown in Fig. 5.<sup>4,5</sup> The type of unglazed paper attached to the top and bottom plate (see 16.2.2) shall be such that it does not add foreign matter (fibers, paper fragments, etc.) to the soil during the rolling process.

6.8 *Spatula*—A spatula or pill knife having a blade about 2 cm ( $\frac{3}{4}$  in.) wide, and about 10 to 13 cm (3 to 4 in.) long.

6.9 *Sieve(s)*—A 200-mm (8-in.) diameter, 425- $\mu$ m (No. 40) sieve conforming to the requirements of Specification E11 and having a rim at least 5 cm (2 in.) above the mesh. A 2.00-mm (No. 10) sieve meeting the same requirements may also be needed.

6.10 *Wash Bottle*, or similar container for adding controlled amounts of water to soil and washing fines from coarse particles.

6.11 *Drying Oven*, thermostatically controlled, preferably of the forced-draft type, capable of continuously maintaining a temperature of  $110 \pm 5^\circ\text{C}$  ( $230 \pm 9^\circ\text{F}$ ) throughout the drying chamber.

6.12 *Washing Pan*, round, flat-bottomed, at least 7.6 cm (3 in.) deep, and slightly larger at the bottom than a 20.3-cm (8-in.) diameter sieve.

## 7. Reagents and Materials

7.1 *Purity of Water*—Where distilled water is referred to in this test method, either distilled or demineralized water may be used. See Note 7 covering the use of tap water.

<sup>4</sup>The plastic limit-rolling device is covered by a patent (U.S. Patent No. 5,027,660).<sup>5</sup> Interested parties are invited to submit information regarding the identification of an alternative(s) to this patented item to ASTM Headquarters. Your comments will receive careful consideration at a meeting of the responsible subcommittee, which you may attend.

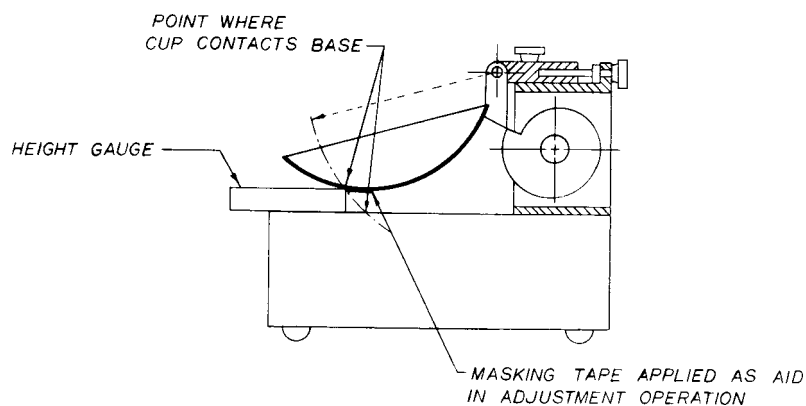
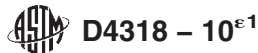

FIG. 2 Calibration for Height-of-Drop





DIMENSIONS

LETTER	A <sup>Δ</sup>	B <sup>Δ</sup>	C <sup>Δ</sup>	D <sup>Δ</sup>	E <sup>Δ</sup>	F <sup>Δ</sup>
MM	2 ± 0.1	11 ± 0.2	40 ± 0.5	8 ± 0.1	50 ± 0.5	2 ± 0.1
LETTER	G	H	J	K <sup>□</sup>	L <sup>Δ</sup>	N
MM	10 MINIMUM	13	60	10 ± 0.05	60 DEG ± 1 DEG	20

<sup>Δ</sup> ESSENTIAL DIMENSIONS

<sup>□</sup> BACK AT LEAST 15 MM FROM TIP

NOTE : DIMENSION A SHOULD BE 1.9-2.0 AND DIMENSION D SHOULD BE 8.0-8.1 WHEN NEW TO ALLOW FOR ADEQUATE SERVICE LIFE

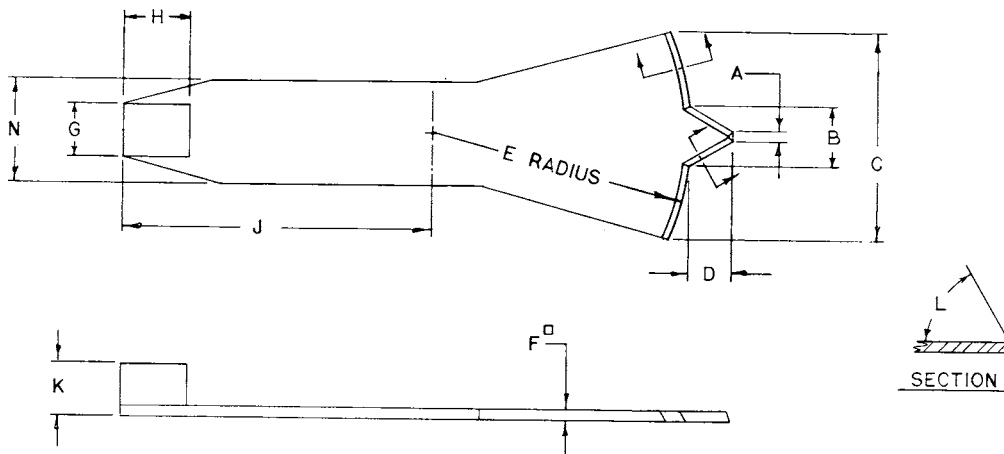
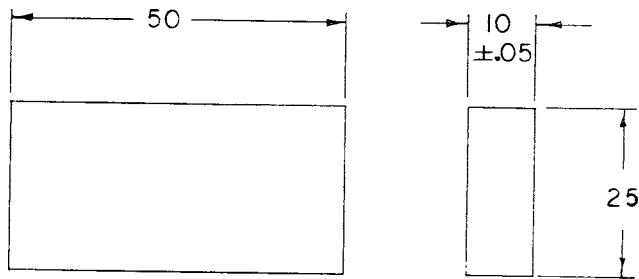

FIG. 3 Grooving Tool (Optional Height-of-Drop Gauge Attached)



DIMENSIONS IN MILLIMETRES  
FIG. 4 Height-of-Drop Gauge

8. Sampling and Specimen

8.1 Samples may be taken from any location that satisfies testing needs. However, Practices C702 and D75 and Guide D420 should be used as guides for selecting and preserving samples from various types of sampling operations. Samples in which specimens will be prepared using the wet-preparation method (10.1) must be kept at their as-sampled water content prior to preparation.

8.1.1 Where sampling operations have preserved the natural stratification of a sample, the various strata must be kept separated and tests performed on the particular stratum of interest with as little contamination as possible from other strata. Where a mixture of materials will be used in

construction, combine the various components in such proportions that the resultant sample represents the actual construction case.

8.1.2 Where data from these test methods are to be used for correlation with other laboratory or field test data, use the same material as used for those tests where possible.

8.2 Specimen—Obtain a representative portion from the total sample sufficient to provide 150 to 200 g of material passing the 425-μm (No. 40) sieve. Free flowing samples (materials) may be reduced by the methods of quartering or splitting. Non-free flowing or cohesive materials shall be mixed thoroughly in a pan with a spatula or scoop and a representative portion scooped from the total mass by making one or more sweeps with a scoop through the mixed mass.

9. Calibration of Apparatus

9.1 Inspection of Wear:

9.1.1 Liquid Limit Device—Determine that the liquid limit device is clean and in good working order. Check the following specific points.

9.1.1.1 Wear of Base—The spot on the base where the cup makes contact should be worn no greater than 10 mm (3/8 in.) in diameter. If the wear spot is greater than this, the base can be machined to remove the worn spot provided the resurfacing does not make the base thinner than specified in 6.1 and the other dimensional relationships are maintained.

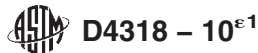

**Dimensions:**

IW—100 mm (4 in.), more or less  
 L—200 mm (8 in.), more or less  
 T-top—10 to 15 mm (3/8 to 1/2 in.) or thicker, see Note B  
 T-bottom—5 mm (1/4 in.) or thicker  
 H—is the height of the slide rails. It shall equal 3.2 mm (1/8 in.) plus the total thickness of the unglazed paper that is not in contact with the top or bottom surface of the slide rails. The tolerance on this height is  $\pm 1/4$  mm ( $\pm 1/100$  in.), see Note C.  
 W—See Note A.

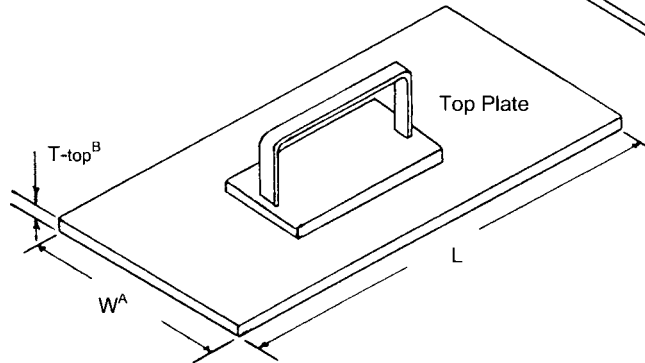
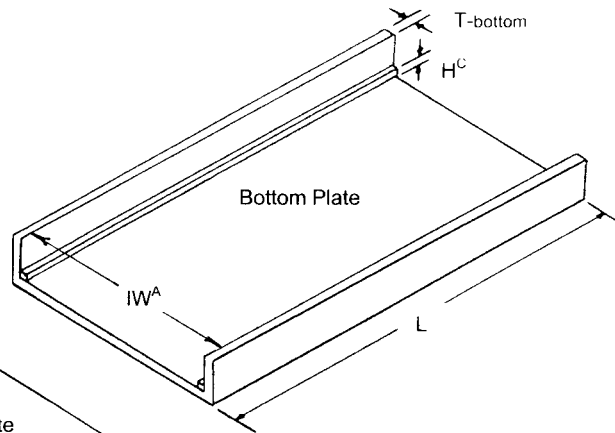
**FIG. 5 Plastic Limit-Rolling Device****Figure 4 Notes:**

- (A) The tolerance between the width of the top plate (W) and the inside width of the bottom plate (IW) shall be such that the top plate slides freely on the rails without wobbling.  
 (B) The top plate shall be rigid enough so that the thickness of the rolled threads is within the tolerances given for the rail height (H).  
 (C) The width of the slide rails shall be between 3 and 6 mm (1/8 and 1/4 in.).

9.1.1.2 *Wear of Cup*—Replace the cup when the grooving tool has worn a depression in the cup 0.1 mm (0.004 in.) deep or when the rim of the cup has been reduced to half its original thickness. Verify that the cup is firmly attached to the cup hanger.

9.1.1.3 *Wear of Cup Hanger*—Verify that the cup hanger pivot does not bind and is not worn to an extent that allows more than 3 mm (1/8 in.) side-to-side movement of the lowest point on the rim.

9.1.1.4 *Wear of Cam*—The cam shall not be worn to an extent that the cup drops before the cup hanger (cam follower) loses contact with the cam.

9.1.1.5 *Rubber Feet*—The feet should prevent the base from bouncing or sliding on the work surface. Replace rubber feet that become hard, cracked, or brittle from age.

9.1.2 *Grooving Tools*—Inspect grooving tools for wear on a frequent and regular basis. The rapidity of wear depends on the material from which the tool is made, and the types of soils being tested. Soils containing a large proportion of fine sand particles may cause rapid wear of grooving tools; therefore, when testing these materials, tools should be inspected more frequently than for other soils.

NOTE 4—The width of the tip of grooving tools is conveniently checked using a pocket-sized measuring magnifier equipped with a millimeter scale. Magnifiers of this type are available from most laboratory supply companies. The depth of the tip of grooving tools can be checked using the depth-measuring feature of vernier calipers.

9.2 *Adjustment of Height-of-Drop*—Adjust the height-of-drop of the cup so that the point on the cup that comes in contact with the base rises to a height of  $10 \pm 0.2$  mm. See Fig. 2 for proper location of the gauge relative to the cup during adjustment.

NOTE 5—A convenient procedure for adjusting the height-of-drop is as follows: place a piece of masking tape across the outside bottom of the cup

parallel with the axis of the cup hanger pivot. The edge of the tape away from the cup hanger should bisect the spot on the cup that contacts the base. For new cups, placing a piece of carbon paper on the base and allowing the cup to drop several times will mark the contact spot. Attach the cup to the device and turn the crank until the cup is raised to its maximum height. Slide the height gauge under the cup from the front, and observe whether the gauge contacts the cup or the tape. (See Fig. 2.) If the tape and cup are both simultaneously contacted, the height-of-drop is ready to be checked. If not, adjust the cup until simultaneous contact is made. Check adjustment by turning the crank at 2 revolutions per second while holding the gauge in position against the tape and cup. If a faint ringing or clicking sound is heard without the cup rising from the gauge, the adjustment is correct. If no ringing is heard or if the cup rises from the gauge, readjust the height-of-drop. If the cup rocks on the gauge during this checking operation, the cam follower pivot is excessively worn and the worn parts should be replaced. Always remove tape after completion of adjustment operation.

**10. Preparation of Test Specimen**

10.1 *Wet Preparation Method*—Except where the dry method of specimen preparation is specified (10.2), prepare the specimen for testing as described in the following sections.

**10.1.1 Material Passes the 425- $\mu$ m (No. 40) Sieve:**

10.1.1.1 Determine by visual and manual methods that the specimen from 8.2 has little or no material retained on a 425- $\mu$ m (No. 40) sieve. If this is the case, prepare 150 to 200 g of material by mixing thoroughly with distilled or demineralized water on the glass plate or mixing dish using the spatula. If desired, soak the material in a mixing/storage dish with a small amount of water to soften the material before the start of mixing. If using Method A, adjust the water content of the material to bring it to a consistency that would require about 25 to 35 blows of the liquid limit device to close the groove (Note 6). For Method B, the number of blows should be between about 20 and 30 blows.

10.1.1.2 If, during mixing, a small percentage of material is encountered that would be retained on a 425- $\mu$ m (No. 40)

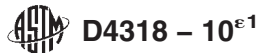

sieve, remove these particles by hand (if possible). If it is impractical to remove the coarser material by hand, remove small percentages (less than about 15 %) of coarser material by working the material (having the above consistency) through a 425- $\mu\text{m}$  sieve. During this procedure, use a piece of rubber sheeting, rubber stopper, or other convenient device provided the procedure does not distort the sieve or degrade material that would be retained if the washing method described in 10.1.2 were used. If larger percentages of coarse material are encountered during mixing, or it is considered impractical to remove the coarser material by the procedures just described, wash the sample as described in 10.1.2. When the coarse particles found during mixing are concretions, shells, or other fragile particles, do not crush these particles to make them pass a 425- $\mu\text{m}$  sieve, but remove by hand or by washing.

10.1.1.3 Place the prepared material in the mixing/storage dish, check its consistency (adjust if required), cover to prevent loss of moisture, and allow to stand (cure) for at least 16 h (overnight). After the standing period and immediately before starting the test, thoroughly remix the soil.

NOTE 6—The time taken to adequately mix a soil will vary greatly, depending on the plasticity and initial water content. Initial mixing times of more than 30 min may be needed for stiff, fat clays.

10.1.2 *Material Containing Particles Retained on a 425- $\mu\text{m}$  (No. 40) Sieve:*

10.1.2.1 Place the specimen (see 8.2) in a pan or dish and add sufficient water to cover the material. Allow the material to soak until all lumps have softened and the fines no longer adhere to the surfaces of the coarse particles (Note 7).

NOTE 7—In some cases, the cations of salts present in tap water will exchange with the natural cations in the soil and significantly alter the test results if tap water is used in the soaking and washing operations. Unless it is known that such cations are not present in the tap water, distilled or demineralized water should be used. As a general rule, water containing more than 100 mg/L of dissolved solids should not be used for either the soaking or washing operations.

10.1.2.2 When the material contains a large percentage of particles retained on the 425- $\mu\text{m}$  (No. 40) sieve, perform the following washing operation in increments, washing no more than 0.5 kg (1 lb) of material at one time. Place the 425- $\mu\text{m}$  sieve in the bottom of the clean pan. Transfer, without any loss of material, the soil-water mixture onto the sieve. If gravel or coarse sand particles are present, rinse as many of these as possible with small quantities of water from a wash bottle, and discard. Alternatively, transfer the soil-water mixture over a 2.00-mm (No. 10) sieve nested atop the 425- $\mu\text{m}$  sieve, rinse the fine material through and remove the 2.00-mm sieve. After washing and removing as much of the coarser material as possible, add sufficient water to the pan to bring the level to about 13 mm ( $\frac{1}{2}$  in.) above the surface of the 425- $\mu\text{m}$  sieve. Agitate the slurry by stirring with the fingers while raising and lowering the sieve in the pan and swirling the suspension so that fine material is washed from the coarser particles. Disaggregate fine soil lumps that have not slaked by gently rubbing them over the sieve with the fingertips. Complete the washing operation by raising the sieve above the water surface and rinsing the material retained with a small amount of clean water. Discard material retained on the 425- $\mu\text{m}$  sieve.

10.1.2.3 Reduce the water content of the material passing the 425- $\mu\text{m}$  (No. 40) sieve until it approaches the liquid limit. Reduction of water content may be accomplished by one or a combination of the following methods: (a) exposing to air currents at room temperature, (b) exposing to warm air currents from a source such as an electric hair dryer, (c) decanting clear water from surface of the suspension, (d) filtering in a Büchner funnel or using filter candles, or (e) draining in a colander or plaster of Paris dish lined with high retentivity,<sup>6</sup> high wet-strength filter paper. If a plaster of Paris dish is used, take care that the dish never becomes sufficiently saturated that it fails to absorb water into its surface. Thoroughly dry dish between uses. During evaporation and cooling, stir the material often enough to prevent over-drying of the fringes and soil pinnacles on the surface of the mixture. For materials containing soluble salts, use a method of water reduction (a or b) that will not eliminate the soluble salts from the test specimen.

10.1.2.4 If applicable, remove the material retained on the filter paper. Thoroughly mix this material or the above material on the glass plate or in the mixing dish using the spatula. Adjust the water content of the mixture, if necessary, by adding small increments of distilled or demineralized water or by allowing the mixture to dry at room temperature while mixing on the glass plate. If using Method A, the material should be at a water content that would require about 25 to 35 blows of the liquid limit device to close the groove. For Method B, the number of blows should be between about 20 and 30. Put, if necessary, the mixed material in the storage dish, cover to prevent loss of moisture, and allow to stand (cure) for at least 16 h. After the standing period and immediately before starting the test, thoroughly remix the specimen.

## 10.2 *Dry Preparation Method:*

10.2.1 Dry the specimen from 8.2 at room temperature or in an oven at a temperature not exceeding 60°C until the soil clods will pulverize readily. Disaggregation is expedited if the material is not allowed to completely dry. However, the material should have a dry appearance when pulverized.

10.2.2 Pulverize the material in a mortar with a rubber-tipped pestle or in some other way that does not cause breakdown of individual particles. When the coarse particles found during pulverization are concretions, shells, or other fragile particles, do not crush these particles to make them pass a 425- $\mu\text{m}$  (No. 40) sieve, but remove by hand or other suitable means, such as washing. If a washing procedure is used, follow 10.1.2.1 – 10.1.2.4.

10.2.3 Separate the material on a 425- $\mu\text{m}$  (No. 40) sieve, shaking the sieve by hand to assure thorough separation of the finer fraction. Return the material retained on the 425- $\mu\text{m}$  sieve to the pulverizing apparatus and repeat the pulverizing and sieving operations. Stop this procedure when most of the fine material has been disaggregated and material retained on the 425- $\mu\text{m}$  sieve consists of individual particles.

10.2.4 Place material retained on the 425- $\mu\text{m}$  (No. 40) sieve after the final pulverizing operations in a dish and soak in a

<sup>6</sup> S and S 595 filter paper available in 320-mm circles has proven satisfactory. If you are aware of alternative suppliers, please provide this information to ASTM International Headquarters. Your comments will receive careful consideration at a meeting of the responsible technical committee,<sup>1</sup> which you may attend.

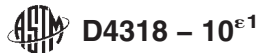

small amount of water. Stir this mixture and transfer it to a 425- $\mu\text{m}$  sieve, catching the water and any suspended fines in the washing pan. Pour this suspension into a dish containing the dry soil previously sieved through the 425- $\mu\text{m}$  sieve. Discard material retained on the 425- $\mu\text{m}$  sieve.

10.2.5 Proceed as described in 10.1.2.3 and 10.1.2.4.

## MULTIPOINT LIQUID LIMIT—METHOD A

### 11. Procedure

11.1 Thoroughly remix the specimen (soil) in its mixing dish, and, if necessary, adjust its water content until the consistency requires about 25 to 35 blows of the liquid limit device to close the groove. Using a spatula, place a portion(s) of the prepared soil in the cup of the liquid limit device at the point where the cup rests on the base, squeeze it down, and spread it into the cup to a depth of about 10 mm at its deepest point, tapering to form an approximately horizontal surface. Take care to eliminate air bubbles from the soil pat, but form the pat with as few strokes as possible. Keep the unused soil in the mixing/storage dish. Cover the dish with a wet towel (or use other means) to retain the moisture in the soil.

11.2 Form a groove in the soil pat by drawing the tool, beveled edge forward, through the soil on a line joining the highest point to the lowest point on the rim of the cup. When cutting the groove, hold the grooving tool against the surface of the cup and draw in an arc, maintaining the tool perpendicular to the surface of the cup throughout its movement. See Fig. 6. In soils where a groove cannot be made in one stroke without tearing the soil, cut the groove with several strokes of the grooving tool. Alternatively, cut the groove to slightly less than

required dimensions with a spatula and use the grooving tool to bring the groove to final dimensions. Exercise extreme care to prevent sliding the soil pat relative to the surface of the cup.

11.3 Verify that no crumbs of soil are present on the base or the underside of the cup. Lift and drop the cup by turning the crank at a rate of 1.9 to 2.1 drops per second until the two halves of the soil pat come in contact at the bottom of the groove along a distance of 13 mm ( $\frac{1}{2}$  in.). See Fig. 7 and Fig. 8. The base of the machine shall not be held with the hand, or hands, while the crank is turned.

NOTE 8—Use of a scale is recommended to verify that the groove has closed 13 mm ( $\frac{1}{2}$  in.).

11.4 Verify that an air bubble has not caused premature closing of the groove by observing that both sides of the groove have flowed together with approximately the same shape. If a bubble has caused premature closing of the groove, reform the soil in the cup, adding a small amount of soil to make up for that lost in the grooving operation and repeat 11.1 – 11.3. If the soil slides on the surface of the cup, repeat 11.1 – 11.3 at a higher water content. If, after several trials at successively higher water contents, the soil pat continues to slide in the cup or if the number of blows required to close the groove is always less than 25, record that the liquid limit could not be determined, and report the soil as nonplastic without performing the plastic limit test.

11.5 Record the number of drops,  $N$ , required to close the groove. Remove a slice of soil approximately the width of the spatula, extending from edge to edge of the soil cake at right

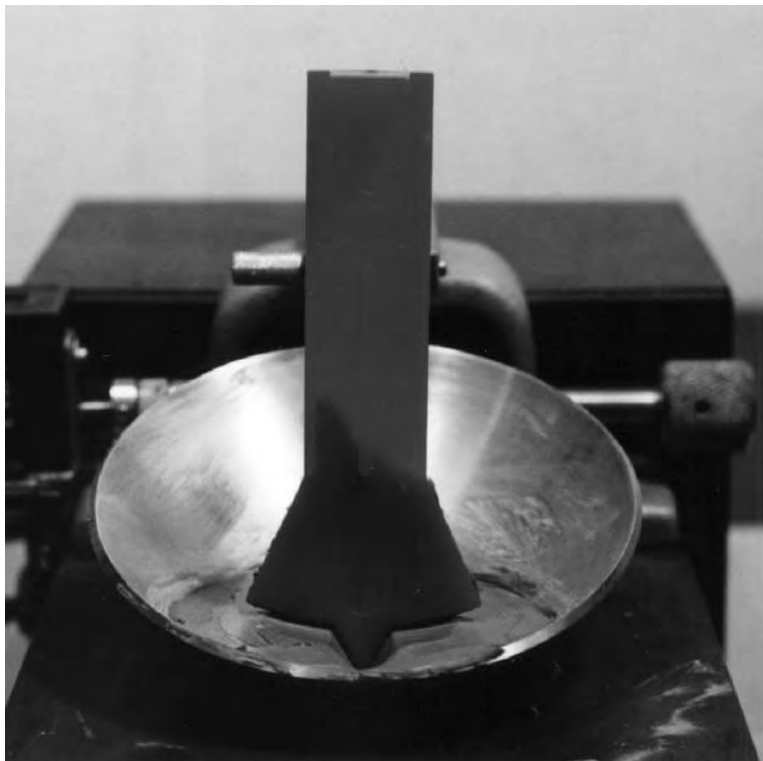



FIG. 6 Example of Grooving Tool Placed in a Properly Grooved Soil Pat

**D4318 – 10<sup>ε</sup>1**

**FIG. 7 Grooved Soil Pat in Liquid Limit Device**



**FIG. 8 Soil Pat After Groove Has Closed**

angles to the groove and including that portion of the groove in which the soil flowed together, place in a container of known mass, and cover.

11.6 Return the soil remaining in the cup to the dish. Wash and dry the cup and grooving tool and reattach the cup to the carriage in preparation for the next trial.

11.7 Remix the entire soil specimen in the dish adding distilled water to increase the water content of the soil and

decrease the number of blows required to close the groove. Repeat 11.1 – 11.6 for at least two additional trials producing successively lower numbers of blows to close the groove. One of the trials shall be for a closure requiring 25 to 35 blows, one for closure between 20 and 30 blows, and one trial for a closure requiring 15 to 25 blows.

11.8 Determine the water content,  $W^m$ , of the soil specimen from each trial in accordance with Test Methods **D2216**.



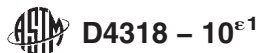

11.8.1 Determination of initial masses (container plus moist soil) should be performed immediately after completion of the test. If the test is to be interrupted for more than about 15 minutes, determine the mass of the water content specimens already obtained at the time of the interruption.

## 12. Calculation

12.1 Plot the relationship between the water content,  $W^n$ , and the corresponding number of drops,  $N$ , of the cup on a semilogarithmic graph with the water content as ordinates on the arithmetical scale, and the number of drops as abscissas on a logarithmic scale. Draw the best straight line through the three or more plotted points.

12.2 Take the water content corresponding to the intersection of the line with the 25-drop abscissa as the liquid limit of the soil and round to the nearest whole number. Computational methods may be substituted for the graphical method for fitting a straight line to the data and determining the liquid limit.

### ONE-POINT LIQUID LIMIT—METHOD B

## 13. Procedure

13.1 Proceed as described in 11.1 – 11.5 except that the number of blows required to close the groove shall be 20 to 30. If less than 20 or more than 30 blows are required, adjust the water content of the soil and repeat the procedure.

13.2 Immediately after removing a water content specimen as described in 11.5, reform the soil in the cup, adding a small amount of soil to make up for that lost in the grooving and water content sampling processes.

13.2.1 As an alternative to reforming the soil in the brass cup after removing the water content specimen, the soil remaining in the cup can be removed from the cup, remixed with the soil in the mixing container and a new specimen placed in the cup as described in 11.1.

13.3 Repeat 11.2 – 11.5.

13.4 If the second closing of the groove requires the same number of drops or no more than two drops difference, secure another water content specimen. If the difference of the number of drops between the first and second closings of the groove is greater than two, remix the entire specimen and repeat the procedure, beginning at 13.1, until two successive closures having the same number of drops or no more than two drops difference are obtained.

NOTE 9—Excessive drying or inadequate mixing will cause the number of blows to vary.

13.5 Determine water contents of the two specimens in accordance with 11.8.

## 14. Calculation

14.1 Determine the liquid limit for each water content specimen using one of the following equations:

$$LL^n = W^n \cdot \left( \frac{N}{25} \right)^{0.121}$$

or

$$LL^n = k \cdot W^n$$

**TABLE 1 Factors for Obtaining Liquid Limit from Water Content and Number of Drops Causing Closure of Groove**

N (Number of Drops)	k (Factor for Liquid Limit)
20	0.973
21	0.979
22	0.985
23	0.990
24	0.995
25	1.000
26	1.005
27	1.009
28	1.014
29	1.018
30	1.022

where:

$LL^n$  = one point liquid limit for given trial, %,

$N$  = number of blows causing closure of the groove for given trial,

$W^n$  = water content for given trial, %, and

$k$  = factor given in Table 1.

14.1.1 The liquid limit,  $LL$ , is the average of the two trial liquid-limit values, to the nearest whole number (without the percent designation).

14.2 If the difference between the two trial liquid-limit values is greater than one percentage point, repeat the test as described in 13.1 through 14.1.1.

### PLASTIC LIMIT

## 15. Preparation of Test Specimen

15.1 Select a 20-g or more portion of soil from the material prepared for the liquid limit test; either, after the second mixing before the test, or from the soil remaining after completion of the liquid limit test. Reduce the water content of the soil to a consistency at which it can be rolled without sticking to the hands by spreading or mixing continuously on the glass plate or in the mixing/storage dish. The drying process may be accelerated by exposing the soil to the air current from an electric fan, or by blotting with paper, that does not add any fiber to the soil. Paper such as hard surface paper toweling or high wet-strength filter paper is adequate.

## 16. Procedure

16.1 From this plastic-limit specimen, select a 1.5 to 2.0 g portion. Form the selected portion into an ellipsoidal mass.

16.2 Roll the soil mass by one of the following methods (hand or rolling device):

16.2.1 *Hand Method*—Roll the mass between the palm or fingers and the ground-glass plate with just sufficient pressure to roll the mass into a thread of uniform diameter throughout its length (see Note 10). The thread shall be further deformed on each stroke so that its diameter reaches 3.2 mm ( $\frac{1}{8}$  in.), taking no more than 2 min (see Note 11). The amount of hand or finger pressure required will vary greatly according to the soil being tested, that is, the required pressure typically increases with increasing plasticity. Fragile soils of low plasticity are best rolled under the outer edge of the palm or at the base of the thumb.

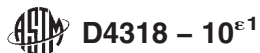

NOTE 10—A normal rate of rolling for most soils should be 80 to 90 strokes per minute, counting a stroke as one complete motion of the hand forward and back to the starting position. This rate of rolling may have to be decreased for very fragile soils.

NOTE 11—A 3.2-mm ( $\frac{1}{8}$ -in.) diameter rod or tube is useful for frequent comparison with the soil thread to ascertain when the thread has reached the proper diameter.

16.2.2 *Rolling Device Method*—Attach smooth unglazed paper to both the top and bottom plates of the plastic limit-rolling device. Place the soil mass on the bottom plate at the midpoint between the slide rails. Place the top plate in contact with the soil mass(es). Simultaneously apply a slight downward force and back and forth motion to the top plate so that the top plate comes into contact with the side rails within 2 min (see [Notes 10 and 12](#)). During this rolling process, the end(s) the soil thread(s) shall not contact the side rail(s). If this occurs, roll a smaller mass of soil (even if it is less than that mentioned in [Section 16.1](#)).

NOTE 12—In most cases, two soil masses (threads) can be rolled simultaneously in the plastic limit-rolling device.

16.3 When the diameter of the thread becomes 3.2 mm, break the thread into several pieces. Squeeze the pieces together, knead between the thumb and first finger of each hand, reform into an ellipsoidal mass, and re-roll. Continue this alternate rolling to a thread 3.2 mm in diameter, gathering together, kneading and re-rolling, until the thread crumbles under the pressure required for rolling and the soil can no longer be rolled into a 3.2-mm diameter thread (see [Fig. 9](#)). It has no significance if the thread breaks into threads of shorter length. Roll each of these shorter threads to 3.2 mm in diameter. The only requirement for continuing the test is that these threads can be reformed into an ellipsoidal mass and rolled out again. The operator shall at no time attempt to produce failure at exactly 3.2-mm diameter by allowing the

thread to reach 3.2 mm, then reducing the rate of rolling or the hand pressure, or both, while continuing the rolling without further deformation until the thread falls apart. It is permissible, however, to reduce the total amount of deformation for feebly plastic soils by making the initial diameter of the ellipsoidal mass nearer to the required 3.2-mm final diameter. If crumbling occurs when the thread has a diameter greater than 3.2 mm, this shall be considered a satisfactory end point, provided the soil has been previously rolled into a thread 3.2 mm in diameter. Crumbling of the thread will manifest itself differently with the various types of soil. Some soils fall apart in numerous small aggregations of particles, others may form an outside tubular layer that starts splitting at both ends. The splitting progresses toward the middle, and finally, the thread falls apart in many small platy particles. Fat clay soils require much pressure to deform the thread, particularly as they approach the plastic limit. With these soils, the thread breaks into a series of barrel-shaped segments about 3.2 to 9.5 mm ( $\frac{1}{8}$  to  $\frac{3}{8}$  in.) in length.

16.4 Gather the portions of the crumbled thread together and place in a container of known mass. Immediately cover the container.

16.5 Select another 1.5 to 2.0-g portion of soil from the plastic-limit specimen and repeat the operations described in [16.1 and 16.2](#) until the container has at least 6 g of soil.

16.6 Repeat [16.1 – 16.5](#) to make another container holding at least 6 g of soil. Determine the water content of the soil contained in the containers in accordance with Test Methods [D2216](#). See [11.8.1](#).

## 17. Calculation

17.1 Compute the average of the two water contents (trial plastic limits) and round to the nearest whole number. This

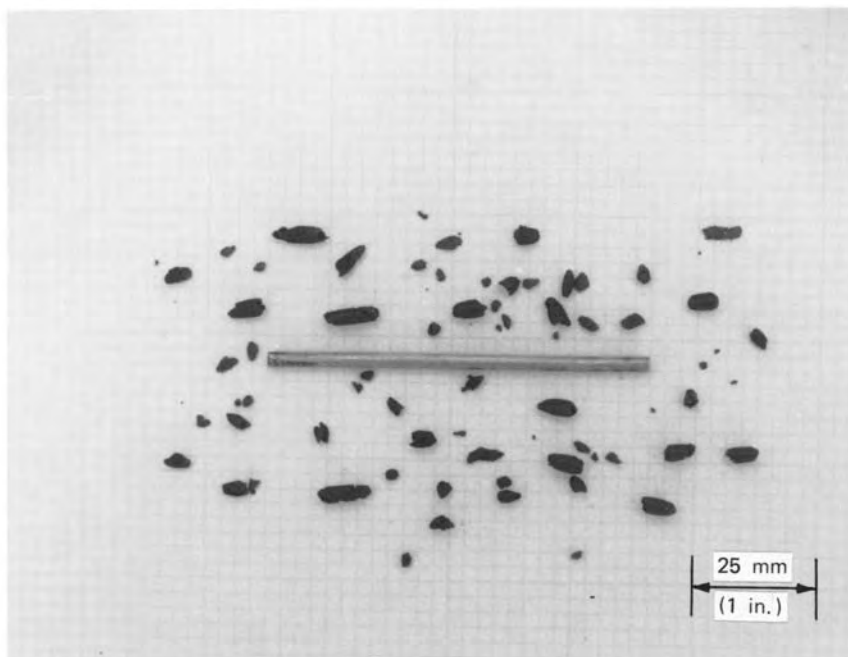
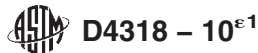

FIG. 9 Lean Clay Soil at the Plastic Limit





value is the plastic limit, *PL*. Repeat the test if the difference between the two trial plastic limits is greater than the acceptable range for two results listed in **Table 2** for single-operator precision, that is, 1.4 percentage points; that is,  $(2.8 \times 0.5)$ .

## PLASTICITY INDEX

### 18. Calculation

18.1 Calculate the plasticity index as follows:

$$PI = LL - PL$$

where:

*LL* = liquid limit (whole number), and

*PL* = plastic limit (whole number).

18.1.1 Both *LL* and *PL* are whole numbers. If either the liquid limit or plastic limit could not be determined, or if the plastic limit is equal to or greater than the liquid limit, report the soil as nonplastic, NP.

### 19. Report: Test Data Sheet(s)/Form(s)

19.1 The terminology used to specify how data are recorded on the test data sheet(s)/form(s), as given below, is covered in 1.9.

19.2 Record as a minimum the following information:

19.2.1 Sample/specimen identifying information, such as project name, project number, boring number, depth (m or ft).

19.2.2 Description of sample, such as approximate maximum grain size, estimate of the percentage of sample retained on the 425- $\mu\text{m}$  (No. 40) sieve, as-received water content.

19.2.3 Details of specimen preparation, such as wet or dry (air-dried or oven-dried), method of removing particles larger than the 425- $\mu\text{m}$  (No. 40) sieve.

19.2.4 Any special specimen selection process used, such as removal of sand lenses from an intact (undisturbed) sample.

19.2.5 Equipment used, such as hand rolled or mechanical rolling device for plastic limit, manual or mechanical liquid limit device, metal or plastic grooving tool.

19.2.6 Liquid limit, plastic limit, and plasticity index to the nearest whole number, omitting the percent designation. If the liquid limit or plastic limit tests could not be performed, or if the plastic limit is equal to or greater than the liquid limit, report the soil as nonplastic, NP.

19.2.7 Procedure by which liquid limit was performed, if it differs from the multipoint method.

### 20. Precision and Bias

20.1 *Precision*—Criteria for judging the acceptability of test results obtained by these test methods on a range of soil types are given in **Tables 2 and 3**. In performing these test methods, Method A and the Wet Preparation Method (except soil was air-dried) were used.

20.1.1 These estimates of precision are based on the results of the interlaboratory program conducted by the ASTM Reference Soils and Testing Program.<sup>7</sup> In this program, some laboratories performed three replicate tests per soil type (triplicate test laboratory), while other laboratories performed a single test per soil type (single-test laboratory). A description of the soils tested is given in **20.1.5**. The precision estimates vary with soil type and method(s) used. Judgment is required when applying these estimates to another soil and method used (Method A or B, or Wet or Dry Preparation Method).

20.1.2 The data in **Table 2** are based on three replicate tests performed by each triplicate test laboratory on each soil type. The single operator and multilaboratory standard deviation shown in **Table 2**, Column 4, were obtained in accordance with Practice **E691**, which recommends each testing laboratory perform a minimum of three replicate tests. Results of two properly conducted tests performed by the same operator on the same material, using the same equipment, and in the shortest practical period of time should not differ by more than

<sup>7</sup> Supporting data have been filed at ASTM International Headquarters and may be obtained by requesting Research Report RR:D18-1013. Contact ASTM Customer Service at [service@astm.org](mailto:service@astm.org).

**TABLE 2 Summary of Test Results from Triplicate Test Laboratories (Atterberg Limits)**

(1) Soil Type	(2) Number of Triplicate Test Laboratories			(3) Average Value <sup>A</sup> (Percentage Points)			(4) Standard Deviation <sup>B</sup> (Percentage Points)			(5) Acceptable Range of Two Results <sup>C</sup> (Percentage Points)		
	LL	PL	PI	LL	PL	PI	LL	PL	PI	LL	PL	PI
	Type Test											
	<i>Single-Operator Results (Within-Laboratory Repeatability)</i>											
CH	13	13	13	59.8	20.6	39.2	0.7	0.5	0.8	2	1	2
CL	14	13	13	33.4	19.9	13.6	0.3	0.4	0.5	1	1	1
ML	12	11	11	27.4	23.4 <sup>D</sup>	4.1 <sup>D</sup>	0.5	0.3	0.6	2	1	2
	<i>Multilaboratory Results (Between-Laboratory Reproducibility)</i>											
CH	13	13	13	59.8	20.6	39.2	1.3	2.0	2.5	4	6	7
CL	14	13	13	33.4	19.9	13.6	1.0	1.2	1.7	3	3	5
ML	12	11	11	27.4	23.4 <sup>D</sup>	4.1 <sup>D</sup>	1.3	0.9	1.9	4	3	5

<sup>A</sup> The number of significant digits and decimal places presented are representative of the input data. In accordance with Practice **D6026**, the standard deviation and acceptable range of results can not have more decimal places than the input data.

<sup>B</sup> Standard deviation is calculated in accordance with Practice **E691** and is referred to as the 1s limit.

<sup>C</sup> Acceptable range of two results is referred to as the d2s limit. It is calculated as  $-1.960 \cdot \sqrt{2} \cdot 1s$ , as defined by Practice **E177**. The difference between two properly conducted tests should not exceed this limit. The number of significant digits/decimal places presented is equal to that prescribed by this test method or Practice **D6026**. In addition, the value presented can have the same number of decimal places as the standard deviation, even if that result has more significant digits than the standard deviation.

<sup>D</sup> For the ML soil, 2 out of 14 triplicate test laboratories reported the soil as nonplastic.

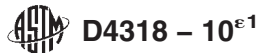

**TABLE 3 Summary of Single-Test Result from Each Laboratory (Atterberg Limits)<sup>A</sup>**

(1) Soil Type	(2) Number of Test Laboratories	(3) Average Value (Percentage Points)			(4) Standard Deviation (Percentage Points)			(5) Acceptable Range of Two Results (Percentage Points)		
		LL	PL	PI	LL	PL	PI	LL	PL	PI
CH	24	59.9	20.4	39.5	2.1	2.7	3.1	6	7	9
CL	24	33.3	19.9	13.4	0.8	1.3	1.6	2	4	4
ML	18	27.1	23.2 <sup>B</sup>	3.9 <sup>B</sup>	1.3	1.2	1.8	4	3	5

<sup>A</sup> For column footnotes, see Table 3.

<sup>B</sup> For the ML soil, 6 out of 24 laboratories reported the soil as nonplastic.

the single-operator d<sub>2s</sub> limits shown in Table 2, Column 5. For definition of d<sub>2s</sub> see Footnote C in Table 2. Results of two properly conducted tests performed by different operators and on different days should not differ by more than the multilaboratory d<sub>2s</sub> limits shown in Table 2, Column 5.

20.1.3 In the ASTM Reference Soils and Testing Program, many of the laboratories performed only a single test on each soil type. This is common practice in the design and construction industry. The data for each soil type in Table 3 are based upon the first test results from the triplicate test laboratories and the single test results from the other laboratories. Results

of two properly conducted tests performed by two different laboratories with different operators using different equipment and on different days should not vary by more than the d<sub>2s</sub> limits shown in Table 3, Column 5. The results in Table 2 and Table 3 are dissimilar because the data sets are different.

20.1.4 Table 2 presents a rigorous interpretation of triplicate test data in accordance with Practice E691 from pre-qualified laboratories. Table 3 is derived from test data that represents common practice.

20.1.5 *Soil Types*—Based on the multilaboratory test results, the soils used in the program are described below in accordance with Practice D2487. In addition, the local names of the soils are given.

CH—Fat clay, CH, 99 % fines, LL=60, PI=39, grayish brown, soil had been air dried and pulverized. Local name—Vicksburg Buckshot Clay  
 CL—Lean clay, CL, 89 % fines, LL=33, PI=13, gray, soil had been air dried and pulverized. Local name—Annapolis Clay  
 ML—Silt, ML, 99 % fines, LL=27, PI=4, light brown, soil had been air dried and pulverized. Local name—Vicksburg Silt

20.2 *Bias*—There is no acceptable reference value for these test methods; therefore, bias cannot be determined.

## 21. Keywords

21.1 activity; Atterberg limits; liquid limit; plasticity index; plastic limit

## ANNEX

### (Mandatory Information)

#### A1. RESILIENCE TESTER

A1.1 A device for measuring the resilience of liquid limit device bases is shown in Fig. A1.1. The device consists of a clear acrylic plastic tube and cap, a 3/16-in. diameter steel ball, and a small bar magnet. The cylinder may be cemented to the cap or threaded as shown. The small bar magnet is held in the recess of the cap and the steel ball is fixed into the recess in the underside of the cap with the bar magnet. The cylinder is then turned upright and placed on the top surface of the base to be

tested. Holding the tube lightly against the liquid limit device base with one hand, release the ball by pulling the magnet out of the cap. Use the scale markings on the outside of the cylinder to determine the highest point reached by the bottom of the ball. Repeat the drop at least three times, placing the tester in a different location for each drop. Tests should be conducted at room temperature.

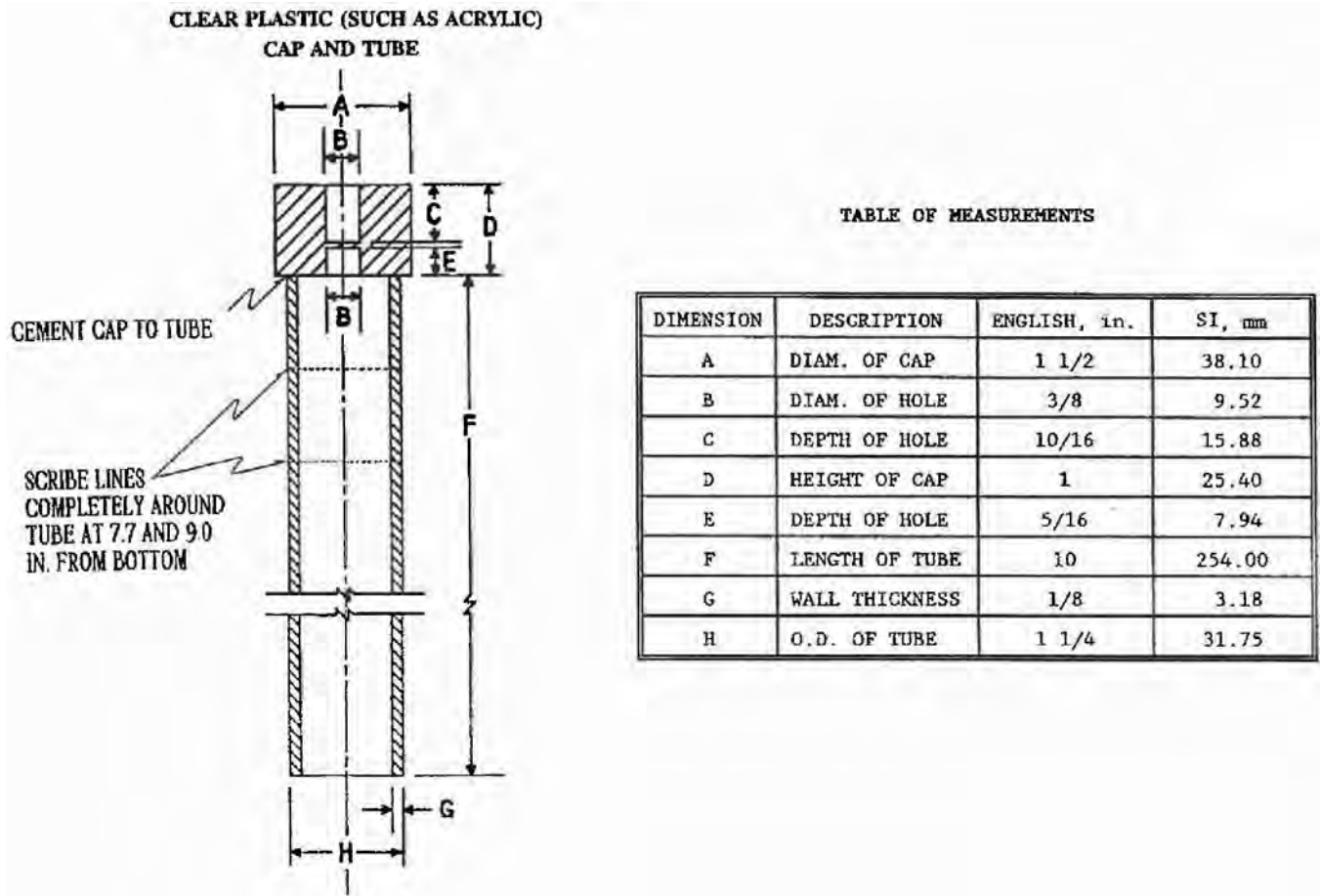

FIG. A1.1 Resilience Tester

## APPENDIX

(Nonmandatory Information)

## X1. SAMPLE DATA SHEET

X1.1 See Fig. X1.1.

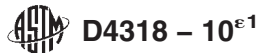

Laboratory Name: Example Project Name: Example Project Number: Example  
 Soil Type: CH-1 Boring Number: N/A Depth (m or ft): N/A  
 Initial Visual Description: CH, brown, highly plastic clay  
 Sample Number: N/A

INITIAL VISUAL USCS GROUP SYMBOL: CH

SPECIMEN PREPARATION	
Wet: <input checked="" type="checkbox"/>	Washed on #40 Sieve
Dry (Air): <input type="checkbox"/>	Dry Sieved on #40 Sieve
Dry (Oven): <input type="checkbox"/>	Mechanically Pushed Through #40 Sieve
Mixed on Glass Plate and Removed Medium Plus Sand Particles <input checked="" type="checkbox"/>	
Mixing Water: Distilled <input checked="" type="checkbox"/>	Demineralized: <input type="checkbox"/> Other: <input type="checkbox"/>

TESTING EQUIPMENT USED	
Plastic Limit:	Hand Rolled <input checked="" type="checkbox"/>
	Mechanical Rolling Device <input type="checkbox"/>
Liquid Limit:	Manual <input checked="" type="checkbox"/>
Apparatus No. ( )	Mechanical <input type="checkbox"/>
Casagrande/ASTM	Metal <input type="checkbox"/>
Grooving Tool:	Plastic <input checked="" type="checkbox"/>

AS-RECEIVED WATER CONTENT (OVEN DRIED)

Container No.	example	example	
Mass Moist Soil + Container, M1 (g)	n/a	n/a	
Mass Dry Soil + Container, M2 (g)			
Mass Container, M3 (g)			Average
WATER CONTENT, w, (%)			

Circle Approximate Max. Grain Size in Sample 3" 1-1/2" 3/4" 3/8" #4 #10 <#10

PLASTIC LIMIT

Container No.	151	s-110	
Mass Moist Soil + Container, M1 (g)	24.44	23.75	
Mass Dry Soil + Container, M2 (g)	22.96	22.13	
Mass Container, M3 (g)	16.76	15.32	Average
WATER CONTENT, w, (%)			

LIQUID LIMIT

Container No.	147	232	152	
Mass Moist Soil + Container, M1 (g)	35.24	37.79	35.88	
Mass Dry Soil + Container, M2 (g)	29.52	30.50	28.46	
Mass Container, M3 (g)	17.19	18.55	16.75	
WATER CONTENT, w, (%)				59.3
NUMBER OF BLOWS, N				32
LIQUID LIMIT, ASTM SINGLE POINT				n/a

Average

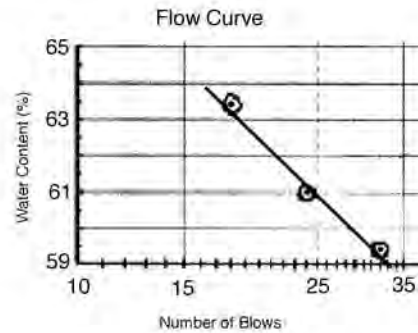

LINEAR REGRESSION ANALYSIS	
w at N = 25 Blows	
Coef. Of Determination, r <sup>2</sup>	

Recommended range of Blow Count for Multiple Point Method A: SUMMARY

15 to 25, 25 to 30, and 25 to 35  
 Recommended range of Blow Count for Single Point Method B:  
 20 to 30  
 $w_o$  or  $w = ((M1-M2)/(M2-M3)) \times 100$   
 LL = Water Content at N=25 blows, from Flow Curve  
 LL by Single Point =  $w \times (N/25)^{0.121}$   
 PL = LL - PL  
 LI =  $(w_o - PL) / (LL - PL)$

TEST METHOD	A	X	B	Wet	X	Dry
AS-RECEIVED WATER CONTENT, w, (%)						n/a
LIQUID LIMIT, LL						61
PLASTIC LIMIT, PL						24
PLASTICITY INDEX, PI						37
LIQUIDITY INDEX, LI						n/a
PERCENTAGE POINTS ABOVE/BELOW A-LINE						n/a
PLASTICITY CHART CLASSIFICATION						CH

PREPARED BY: \_\_\_\_\_ DATE: \_\_\_\_\_ DRY MASS BY: \_\_\_\_\_ CHECKED BY: \_\_\_\_\_  
 TESTED BY: \_\_\_\_\_ DATE: \_\_\_\_\_ CALCULATED BY: \_\_\_\_\_ SPOT CHECKED BY: \_\_\_\_\_  
 REVIEWED BY: \_\_\_\_\_

FIG. X1.1 Sample Data Sheet

SUMMARY OF CHANGES

Committee D18 has identified the location of selected changes to this standard since the last issue (D4318 – 05) that may impact the use of this standard. (Approved January 15, 2010.)

- (1) Corrected 1.6 to reference D4542 and added D4542 to Referenced Documents in Section 2.
- (2) In 1.8 and 1.8.1, clarified use of SI units.
- (3) Added 1.9 referencing D6026 and the use of significant digits and renumbered 1.9 as 1.10.
- (4) In 6.1 and 6.1.1 reworded the requirements for the composition of the base and removed the word “rubber.” “Rubber” was also removed from the label in Fig. 1.
- (5) In 6.1.2 removed the Durometer hardness requirement for the rubber feet.
- (6) In 6.7.1 removed the dimensional requirements for the Ground Glass Plate.
- (7) In 9.1.1.5 added guidance for replacement of rubber feet.
- (8) In 11.1 changed “cup” to “dish” for consistency.
- (9) In 11.3 added instruction that the base shall not be held during testing.
- (10) In 13.2 to 13.5 clarified the instructions to allow two alternative test procedures.
- (11) Section 19 was updated to comply with the D18.91 Special Memorandum on Report Section.



*ASTM International takes no position respecting the validity of any patent rights asserted in connection with any item mentioned in this standard. Users of this standard are expressly advised that determination of the validity of any such patent rights, and the risk of infringement of such rights, are entirely their own responsibility.*

*This standard is subject to revision at any time by the responsible technical committee and must be reviewed every five years and if not revised, either reapproved or withdrawn. Your comments are invited either for revision of this standard or for additional standards and should be addressed to ASTM International Headquarters. Your comments will receive careful consideration at a meeting of the responsible technical committee, which you may attend. If you feel that your comments have not received a fair hearing you should make your views known to the ASTM Committee on Standards, at the address shown below.*

*This standard is copyrighted by ASTM International, 100 Barr Harbor Drive, PO Box C700, West Conshohocken, PA 19428-2959, United States. Individual reprints (single or multiple copies) of this standard may be obtained by contacting ASTM at the above address or at 610-832-9585 (phone), 610-832-9555 (fax), or [service@astm.org](mailto:service@astm.org) (e-mail); or through the ASTM website ([www.astm.org](http://www.astm.org)). Permission rights to photocopy the standard may also be secured from the ASTM website ([www.astm.org/COPYRIGHT/](http://www.astm.org/COPYRIGHT/)).*





**APPENDIX G**

**WA NRCS Conservation Practice Standard No. 313  
Waste Storage Facility**

**NATURAL RESOURCES CONSERVATION SERVICE  
CONSERVATION PRACTICE STANDARD**

**WASTE STORAGE FACILITY**

(No.)

**CODE 313**

**DEFINITION**

A waste storage impoundment made by constructing an embankment and/or excavating a pit or dugout, or by fabricating a structure.

**PURPOSE**

To temporarily store wastes such as manure, wastewater, and contaminated runoff as a storage function component of an agricultural waste management system.

**CONDITIONS WHERE PRACTICE APPLIES**

- Where the storage facility is a component of a planned agricultural waste management system
- Where temporary storage is needed for organic wastes generated by agricultural production or processing
- Where the storage facility can be constructed, operated and maintained without polluting air or water resources
- Where site conditions are suitable for construction of the facility
- To facilities utilizing embankments with an effective height of 35 feet or less where damage resulting from failure would be limited to damage of farm buildings, agricultural land, or township and country roads.
- To fabricated structures including tanks, stacking facilities, and pond appurtenances.

**CRITERIA**

**General Criteria Applicable to All Waste Storage Facilities.**

**Laws and Regulations.** Waste storage facilities must be planned, designed, and constructed to meet all federal, state, and local laws and regulations. All state and local permits that are applicable for the specific site must be met.

**Location.** To minimize the potential for contamination of streams, waste storage facilities should be located outside of floodplains. However, if site restrictions require location within a floodplain, they shall be protected from inundation or damage from a 25-year flood event, or larger if required by laws, rules, and regulations. Waste storage facilities shall be located so the potential impacts from breach of embankment, accidental release, and liner failure are minimized; and separation distances are such that prevailing winds and landscape elements such as building arrangement, landforms, and vegetation minimize odors and protect aesthetic values.

**Storage Period.** The storage period is the maximum length of time anticipated between emptying events. The minimum storage period shall be based on the timing required for environmentally safe waste utilization considering the climate, crops, soil, equipment, and local, state, and federal regulations.

**Design Storage Volume.** The design storage volume equal to the required storage volume shall consist of the total of the following as appropriate:

- (a) Manure, wastewater, and other wastes accumulated during the storage period
- (b) Normal precipitation less evaporation on the surface area (at the design storage volume level) of the facility during the storage period
- (c) Normal runoff from the facility's drainage area during the storage period
- (d) 25-year, 24-hour precipitation on the surface (at the required design storage volume level) of the facility
- (e) 25-year, 24-hour runoff from the facility's drainage area
- (f) Residual solids after liquids have been removed. A minimum of 6 inches shall be provided for tanks
- (g) Additional storage as may be required to meet management goals or regulatory requirements

**Inlet.** Inlets shall be of any permanent type designed to resist corrosion, plugging, freeze damage and ultraviolet ray deterioration while incorporating erosion protection as necessary.

**Emptying Component.** Some type of component shall be provided for emptying storage facilities. It may be a facility such as a gate, pipe, dock, wet well, pumping platform, retaining wall, or ramp. Features to protect against erosion, tampering, and accidental release shall be incorporated as necessary.

**Accumulated Solids Removal.** Provision shall be made for periodic removal of accumulated solids to preserve storage capacity. The anticipated method for doing this must be considered in planning, particularly in determining the configuration of ponds and type of seal, if any.

**Safety.** Design shall include appropriate safety features to minimize the hazards of the facility. Ramps used to empty liquids shall have a slope of 4 horizontal to 1 vertical or flatter. Those used to empty slurry, semi-solid, or solid waste shall have a slope of 10 horizontal to 1 vertical or flatter unless special traction surfaces are provided. Warning signs, fences, ladders, ropes, bars, rails, and other devices shall be provided, as appropriate, to ensure the safety of humans and livestock. Ventilation and warning signs must be

provided for covered waste holding structures, as necessary, to prevent explosion, poisoning, or asphyxiation. Pipelines shall be provided with a water-sealed trap and vent, or similar device, if there is a potential, based on design configuration, for gases to enter buildings or other confined spaces. Ponds and uncovered fabricated structures for liquid or slurry waste with walls less than 5 feet above ground surface shall be fenced and warning signs posted to prevent children and others from using them for other than their intended purpose.

**Erosion Protection.** Embankments and disturbed areas surrounding the facility shall be treated to control erosion.

**Liners.** Liners shall meet or exceed the criteria in Pond Sealing or Lining (PS 521).

#### **Additional Criteria for Waste Storage Ponds**

**Location.** A separation distance of 100 feet for storage ponds and waste confinement areas from existing water wells shall be maintained. A different separation distance will require a site specific evaluation of the aquifer. In no case shall a pond be closer to a well than allowed by state and local regulations.

**Permits and Regulations.** For all waste storage ponds that impound 10 acre-feet or more of wastewater, WAC Chapter 173-175 Dam Safety Regulation, require review and approval of the construction plans and specifications by the Washington Dam Safety Office (Department of Ecology). The plans and specifications are reviewed for conformance with requirements for downstream hazard and dam height classifications; outlet, spillway and energy dissipater configurations; and application of site specific slope stability and design precipitation criteria. These criteria and configurations are listed in "Dam Safety Guidelines: Part IV: Dam Design and Construction, Washington State Department of Ecology, 1993, Document #92-55D.

The impoundment volume is used to determine if a structure exceeds the 10 acre-foot storage threshold. The impoundment volume is the volume of wastewater stored behind the dam from the elevation measured from the lowest

point of the outside limit of the impoundment barrier to the maximum attainable water surface elevation of the reservoir pool that could occur during extreme operating conditions.

For multiple cell waste storage ponds the following shall be considered in the determination of the impoundment volume:

1. Include the volume that would be released from one cell if an embankment were to fail, plus the volume that would drain from adjacent cells through connecting pipe conduits or any other type of spillways that would connect adjacent cells.
2. If the top of the embankments for adjacent cells are not at the same elevation, the breach volume shall include the total volume that would be released from the higher cell plus the total volume that would be released from the lower cell if the common embankment between the cells and the exterior embankment of the lower cell were to both fail.

#### **Soil and foundation.**

The pond shall be located in soils with an acceptable permeability that meets all applicable regulation, or the pond shall be lined. Information and guidance on controlling seepage from waste impoundments can be found in the Agricultural Waste Management Field Handbook (AWMFH), Appendix 10D.

Soil permeability rate of the ponds wetted surface shall not exceed  $1 \times 10^{-6}$  cm/s. The effects of manure sealing will provide approximately one order of magnitude of additional protection resulting in a liner permeability of  $1 \times 10^{-7}$  cm/s. If the foundation permeability rate exceeds  $1 \times 10^{-6}$  cm/s, a compacted clay, amended soil liner or synthetic liner is required. Refer to NRCS Conservation Practice Standard 521A-D.

#### **Criteria for Evaluating the Potential of Waste Storage Pond Earthfill Liner Material.**

The following appropriate tests must be conducted for compacted earthfill liners, by qualified soils testing laboratory or NRCS soil mechanics laboratory. A number of soil samples may need to be tested if one sample

is not representative of the material that is to be used for a Compacted Earthfill liner.

1. ASTM D 420, "Standard Guide to Site Characterization for Engineering, Design, and Construction Purposes Section 8 "Sampling".
2. ASTM D 2487, "Classification of Soils for Engineering Purposes" shall be followed to classify all samples provided for testing.
3. ASTM D 5084, "Measurement of Hydraulic Conductivity of Saturated Porous Material Using a Flexible Wall Permeameter" shall be conducted on soils or soil admixtures documenting the permeability rate of each sample tested with respect to the moisture/density of the sample.
4. ASTM D 698, "Test Methods for Moisture-Density Relations of Soils and Soil-Aggregate Mixtures using 5.5-lb Rammer and 12-in Drop" shall be followed.

The data results from the tests listed above shall be used to establish the compaction parameters for construction. NRCS-WA Construction Specification CS-18, Compacted Earthfill Liner, can be used where the specified degree of compaction is to be checked and controlled by standard compaction tests.

#### **Additional Soil and Foundation Criteria**

**Groundwater and/or seasonal high ground water table.** The depth to the seasonal high water table shall be determined. Washington Engineering Technical Note #7 provides guidance on identifying soil features for establishing the seasonal high ground water table depth.

The pond shall have a bottom elevation that is a minimum of 2 feet above the seasonal high water table unless features of special design are incorporated that address buoyant forces, pond seepage rate and non-encroachment of the water table by contaminants. The water table may be lowered by use of passive perimeter drains, if feasible, to meet this requirement.

#### **Foundation and Subsurface Investigations.**

See reference section for guidance criteria for the subsurface investigations of waste storage ponds.

**Maximum Operating Level.** The maximum operating level for waste storage ponds shall be the pond level that provides for the required volume less the volume contribution of precipitation and runoff from the 25-year, 24-hour storm event plus the volume allowance for residual solids after liquids have been removed. A permanent marker or recorder shall be installed at this maximum operating level to indicate when drawdown should begin. The marker or recorder shall be referenced and explained in the O&M plan.

**Outlet.** No outlet shall automatically release storage from the required design volume. Manually operated outlets shall be of permanent type designed to resist corrosion and plugging.

**Spillway.** Waste storage ponds with an impoundment volume requiring a Dam Safety permit shall have spillway facilities. The spillway may be open channel or pipe conduit that meets the following requirements:

1. For waste storage ponds with a gravity inlet, the spillway shall accommodate design storm events on the area that will contribute runoff to the pond in combination with the design storm even on the pond surface. The design storm even shall be determined according to the Washington State Department of Ecology (DOE) Dam Safety Guidelines. Potential roof runoff shall not be excluded. Roof runoff management facilities are not considered to be effective for the design storm event.
2. For ponds with a pumped inlet, the spillway shall accommodate the pumped inflow in combination with the design storm event on the pond surface. The design storm event shall be determined according to the DOE Dam Safety Guidelines.
3. Multiple cell waste storage ponds shall have a spillway for each cell. These spillways may be through common interior embankments, but at least one cell must have a spillway through an exterior embankment. All spillways shall be designed for erosion control.

**Embankments.** The minimum elevation of the top of the settled embankment shall be 1 foot above the waste storage pond's required volume. This height shall be increased by the amount needed to ensure that the top elevation will be maintained after settlement. This increase shall be not less than 5 percent. The minimum top widths are shown in Table 1. The combined side slopes of the settled embankment shall not be less than 5 horizontal to 1 vertical, and neither slope shall be steeper than 2 horizontal to 1 vertical unless provisions are made to provide stability.

**Table 1 – Minimum Top Widths**

Total embankment Height, ft.	Top Width, ft.
15 or less	8
15 – 20	10
20 – 25	12
25 – 30	14
30 – 35	15

Waste storage ponds with an impoundment volume requiring a Dam Safety permit shall meet the following additional requirements:

1. Normal and minimum freeboard shall be provided according to the DOE Dam Safety Guidelines.
2. For multiple cell ponds, the common embankments between cells shall not have a top elevation lower than the external embankments and the combined side slopes of the common embankment shall meet the 5 horizontal to 1 vertical requirement.
3. Compaction of GW, GP, GM, GC, SW, SP, SM, SC, CL, ML, CH, and MH soil material shall be in accordance with Washington NRCS Construction Specifications CS-15, Earth Fill Class S or Washington NRCS Construction Specification CS-14, Earth Fill Class A.

**Excavations.** Unless supported by a soil investigation, excavated side slopes shall be no steeper than 2 horizontal to 1 vertical.

#### **Additional Criteria for Fabricated Structures**

**Foundation.** The foundations of fabricated waste storage structures shall be proportioned



to safely support all superimposed loads without excessive movement or settlement.

Where a non-uniform foundation cannot be avoided or applied loads may create highly variable foundation loads, settlement should be calculated from site-specific soil test data. Index tests of site soil may allow correlation with similar soils for which test data is available. If no test data is available, presumptive bearing strength values for assessing actual bearing pressures may be obtained from Table 2 or another nationally recognized building code. In using presumptive bearing values, adequate detailing and articulation shall be provided to avoid distressing movements in the structure.

Foundations consisting of bedrock with joints, fractures, or solution channels shall be treated or a separation distance provided consisting of a minimum of 1 foot of impermeable soil between the floor slab and the bedrock or an alternative that will achieve equal protection.

**Table 2 - Presumptive Allowable Bearing Stress Values<sup>1</sup>**

Foundation Description	Allowable Stress
Crystalline Bedrock	12000 psf
Sedimentary Rock	6000 psf
Sandy Gravel or Gravel	5000 psf
Sand, Silty Sand, Clayey Sand, Silty Gravel, Clayey Gravel	3000 psf
Clay, Sandy Clay, Silty Clay, Clayey Silt	2000 psf
<sup>1</sup> Basic Building Code, 12th Edition, 1993, Building Officials and Code Administrators, Inc. (BOCA)	

#### **Foundation and Subsurface Investigations.**

See reference section for guidance criteria for the subsurface investigations of fabricated structures

**Liquid Tightness.** Applications such as tanks, that require liquid tightness shall be designed and constructed in accordance with standard engineering and industry practice

appropriate for the construction materials used to achieve this objective.

**Structural Loadings.** Waste storage structures shall be designed to withstand all anticipated loads including internal and external loads, hydrostatic uplift pressure, concentrated surface and impact loads, water pressure due to seasonal high water table, and frost or ice pressure and load combinations in compliance with this standard and applicable local building codes.

The lateral earth pressures should be calculated from soil strength values determined from the results of appropriate soil tests. Lateral earth pressures can be calculated using the procedures in TR-74. If soil strength tests are not available, the presumptive lateral earth pressure values indicated in Table 3 shall be used.

Lateral earth pressures based upon equivalent fluid assumptions shall be assigned according to the following conditions:

- **Rigid frame or restrained wall.** Use the values shown in Table 3 under the column "Frame tanks," which gives pressures comparable to the at-rest condition.
- **Flexible or yielding wall.** Use the values shown in Table 3 under the column "Free-standing walls," which gives pressures comparable to the active condition. Walls in this category are designed on the basis of gravity for stability or are designed as a cantilever having a base wall thickness to height of backfill ratio not more than 0.085.

Internal lateral pressure used for design shall be 65 lb/ft<sup>2</sup> where the stored waste is not protected from precipitation. A value of 60 lb/ft<sup>2</sup> may be used where the stored waste is protected from precipitation and will not become saturated. Lesser values may be used if supported by measurement of actual pressures of the waste to be stored. If heavy equipment will be operated near the wall, an additional two feet of soil surcharge shall be considered in the wall analysis.

Tank covers shall be designed to withstand both dead and live loads. The live load values for covers contained in ASAE EP378.3, Floor and Suspended Loads on Agricultural

Structures Due to Use, and in ASAE EP 393.2, Manure Storages, shall be the minimum used. The actual axle load for tank wagons having

more than a 2,000 gallon capacity shall be used.

**TABLE 3 - LATERAL EARTH PRESSURE VALUES<sup>1</sup>**

Soil		Equivalent fluid pressure (lb/ft <sup>2</sup> /ft of depth)			
		Above seasonal high water table <sup>2</sup>		Below seasonal high water table <sup>3</sup>	
Description <sup>4</sup>	Unified Classification <sup>4</sup>	Free-standing walls	Frame tanks	Free-standing walls	Frame tanks
Clean gravel, sand or sand-gravel mixtures (maximum 5% fines) <sup>5</sup>	GP, GW, SP, SW	30	50	80	90
Gravel, sand, silt and clay mixtures (less than 50% fines) Coarse sands with silt and and/or clay (less than 50% fines)	All gravel sand dual symbol classifications and GM, GC, SC, SM, SC-SM	35	60	80	100
Low-plasticity silts and clays with some sand and/or gravel (50% or more fines) Fine sands with silt and/or clay (less than 50% fines)	CL, ML, CL-ML SC, SM, SC-SM	45	75	90	105
Low to medium plasticity silts and clays with little sand and/or gravel (50% or more fines)	CL, ML, CL-ML	65	85	95	110
High plasticity silts and clays (liquid limit more than 50) <sup>6</sup>	CH, MH	-	-	-	-

<sup>1</sup> For lightly-compacted soils (85% to 90% maximum standard density.) Includes compaction by use of typical farm equipment.

<sup>2</sup> Also below seasonal high water table if adequate drainage is provided.

<sup>3</sup> Includes hydrostatic pressure.

<sup>4</sup> All definitions and procedures in accordance with ASTM D 2488 and D 653.

<sup>5</sup> Generally, only washed materials are in this category

<sup>6</sup> Not recommended. Requires special design if used.

If the facility is to have a roof, snow and wind loads shall be as specified in ASCE 7-02, Minimum Design Loads for Buildings and Other Structures. If the facility is to serve as part of a foundation or support for a building, the total load shall be considered in the structural design.

Tanks may be designed with or without covers. Covers, beams, or braces that are integral to

structural performance must be indicated on the construction drawings. The openings in covered tanks shall be designed to accommodate equipment for loading, agitating, and emptying. These openings shall be equipped with grills or secure covers for safety, and for odor and vector control.

All structures shall be underlain by free draining material or shall have a footing

located below the anticipated frost depth. Fabricated structures shall be designed according to the criteria in the following references as appropriate:

- Steel: "Manual of Steel Construction", American Institute of Steel Construction.
- Timber: "National Design Specifications for Wood Construction", American Forest and Paper Association.
- Concrete: "Building Code Requirements for Reinforced Concrete, ACI 318", American Concrete Institute.
- Masonry: "Building Code Requirements for Masonry Structures, ACI 530", American Concrete Institute.

**Slabs on Grade.** Slab design shall consider the required performance and the critical applied loads along with both the subgrade material and material resistance of the concrete slab. Where applied point loads are minimal and liquid-tightness is not required, such as barnyard and feedlot slabs subject only to precipitation, and the subgrade is uniform and dense, the minimum slab thickness shall be 4 inches with a maximum joint spacing of 10 feet. Joint spacing can be increased if steel reinforcing is added based on subgrade drag theory.

For applications where liquid-tightness is required such as floor slabs of storage tanks, the minimum thickness for uniform foundations shall be 5 inches and shall contain distributed reinforcing steel. The required area of such reinforcing steel shall be based on subgrade drag theory as discussed in industry guidelines such as American Concrete Institute, ACI 360, "Design of Slabs-on-Grade".

When heavy equipment loads are to be resisted and/or where a non-uniform foundation cannot be avoided, an appropriate design procedure incorporating a subgrade resistance parameter(s) such as ACI 360 shall be used.

## CONSIDERATIONS

Waste storage facilities should be located as close to the source of waste and polluted runoff as practicable. Other considerations for locating the waste storage facility include

vehicle access, wind direction, neighboring dwellings, proximity of streams and floodplains, and visibility.

An increased separation distance from ground water wells will provide additional wellhead protection.

Non-polluted runoff should be excluded from the structure to the fullest extent possible except where its storage is advantageous to the operation of the agricultural waste management system.

Freeboard for waste storage tanks should be considered.

Solid/liquid separation of runoff or wastewater entering pond facilities should be considered to minimize the frequency of accumulated solids removal and to facilitate pumping and application of the stored waste.

Due consideration should be given to environmental concerns, economics, the overall waste management system plan, and safety and health factors.

### **Considerations for Minimizing the Potential for and Impacts of Sudden Breach of Embankment or Accidental Release from the Required Volume.**

Features, safeguards, and/or management measures to minimize the risk of failure or accidental release, or to minimize or mitigate impact of this type of failure should be considered when any of the categories listed in Table 4 might be significantly affected.

The following should be considered either singly or in combination to minimize the potential of or the consequences of sudden breach of embankments when one or more of the potential impact categories listed in Table 4 may be significantly affected:

1. An auxiliary (emergency) spillway
2. Additional freeboard
3. Storage for wet year rather than normal year precipitation
4. Reinforced embankment -- such as, additional top width, flattened and/or armored downstream side slopes
5. Secondary containment

**Table 4 - Potential Impact Categories from Breach of Embankment or Accidental Release**

1. Surface water bodies -- perennial streams, lakes, wetlands, and estuaries
2. Critical habitat for threatened and endangered species.
3. Riparian areas
4. Farmstead, or other areas of habitation
5. Off-farm property
6. Historical and/or archaeological sites or structures that meet the eligibility criteria for listing in the National Register of Historical Places.

The following options should be considered to minimize the potential for accidental release from the required volume through gravity outlets when one or more of the potential impact categories listed in Table 4 may be significantly affected:

1. Outlet gate locks or locked gate housing
2. Secondary containment
3. Alarm system
4. Another means of emptying the required volume

**Considerations for Minimizing the Potential of Waste Storage Pond Liner Failure.**

Sites with categories listed in Table 5 should be avoided unless no reasonable alternative exists. Under those circumstances, consideration should be given to providing an additional measure of safety from pond seepage when any of the potential impact categories listed in Table 5 may be significantly affected.

**Table 5 - Potential Impact Categories for Liner Failure**

1. Any underlying aquifer is at a shallow depth and not confined
2. The vadose zone is rock
3. The aquifer is a domestic water supply or ecologically vital water supply
4. The site is located in an area of solutionized bedrock such as limestone or gypsum.

Should any of the potential impact categories listed in Table 5 be affected, consideration should be given to the following:

1. A clay liner designed in accordance with procedures of AWMFH Appendix 10D with a thickness and coefficient of permeability so that specific discharge is less than  $1 \times 10^{-6}$  cm/sec
2. A flexible membrane liner over a clay liner
3. A geosynthetic clay liner (GCL) flexible membrane liner
4. A concrete liner designed in accordance with slabs on grade criteria for fabricated structures requiring water tightness

**Considerations for Improving Air Quality**

To reduce emissions of greenhouse gases, ammonia, volatile organic compounds, and odor, other practices such as Anaerobic Digester – Ambient Temperature (365), Anaerobic Digester – Controlled Temperature (366), Waste Facility Cover (367), and Composting Facility (317) can be added to the waste management system.

Adjusting pH below 7 may reduce ammonia emissions from the waste storage facility but may increase odor when waste is surface applied (see Waste Utilization, 633).

Some fabric and organic covers have been shown to be effective in reducing odors.

**PLANS AND SPECIFICATIONS**

Plans and specifications shall be prepared in accordance with the criteria of this standard and shall describe the requirements for

applying the practice to achieve its intended use.

### **OPERATION AND MAINTENANCE**

An operation and maintenance plan shall be developed that is consistent with the purposes of the practice, its intended life, safety requirements, and the criteria for its design.

The plan shall contain the operational requirements for emptying the storage facility. This shall include the requirement that waste shall be removed from storage and utilized at locations, times, rates, and volume in accordance with the overall waste management system plan.

In addition, for ponds, the plan shall include an explanation of the permanent marker or recorder installed to indicate the maximum operating level.

The plan shall include a strategy for removal and disposition of waste with the least environmental damage during the normal storage period to the extent necessary to insure the pond's safe operation. This strategy is for the removal of the contribution of unusual storm events that may cause the pond to fill to capacity prematurely with subsequent design inflow and usual precipitation prior to the end of the normal storage period.

Development of an emergency action plan should be considered for waste storage facilities where there is a potential for significant impact from breach or accidental release. The plan shall include site-specific provisions for emergency actions that will minimize these impacts.

### **REFERENCES**

Subsurface investigations guidance for waste storage ponds:

"Guidance for Geological Site Explorations of Waste Storage Ponds" in Washington Engineering Technical Note #5.

This reference is available for Washington State in Section 1 of the NRCS electronic Field Office Technical Guide available on the web at the following site:

<http://www.nrcs.usda.gov/technical/efotg/>

Subsurface investigations for waste storage ponds and fabricated structures:

[Agricultural Waste Management Field Handbook](#), Chapter 7, Geological and Ground Water Considerations, section 651.0704 Site investigations for planning and design.

This reference is available on-line from the NRCS Conservation Engineering Division and listed under the Environmental Engineering section available on the web at the following site:

<http://www.info.usda.gov/CED/>





**APPENDIX H**

**WA NRCS Conservation Practice Standard No. 360  
Waste Facility Closure**

**NATURAL RESOURCES CONSERVATION SERVICE  
CONSERVATION PRACTICE STANDARD**

**WASTE FACILITY CLOSURE**

(No.)

**CODE 360**

**DEFINITION**

The decommissioning of facilities, and/or the rehabilitation of contaminated soil, in an environmentally safe manner, where agricultural waste has been handled, treated, and/or stored and is no longer used for the intended purpose.

**PURPOSE**

- Protect the quality of surface water and groundwater resources.
- Mitigate air emissions.
- Eliminate a safety hazard for humans and livestock.
- Safeguard the public health.

**CONDITIONS WHERE PRACTICE APPLIES**

This practice applies to agricultural waste facilities or livestock production sites that are no longer needed as a part of a waste management system and are to be permanently closed or converted for another use. These facilities include liquid/dry waste storage facilities, confined animal housing, feedlots, livestock yards, or composting facilities.

This practice applies where impoundments that are to be converted to fresh water storage meet current NRCS standards.

Where structures that include agricultural waste storage, such as confined animal housing, are to be decommissioned, this practice will apply to the removal of the waste and rehabilitation of soil within the facility.

This practice applies to remediation of soil contaminated by agricultural wastes that have been stored on-site.

It does not apply to sites contaminated by materials that require the issuance of a hazardous waste permit, such as fuel or pesticides.

**CRITERIA**

**General Criteria Applicable to All Purposes**

The closure shall comply with all Federal, State, and local laws, rules, and regulations including national pollutant discharge elimination system (NPDES) requirements.

Existing waste transfer components that convey to waste facilities or provide drainage from the facility area shall be removed and replaced with compacted earth material or otherwise rendered unable to convey waste.

Remove manure, agricultural waste, and contaminated soil to the maximum extent practicable. All manure and agricultural waste that could negatively impact water and/or air quality or pose a safety hazard shall be removed as deemed practicable. All liquid, slurry, sludge, and solid waste, and soil removed from the facility shall be utilized in accordance with NRCS Conservation Practice Standards, Nutrient Management, Code 590 and/or Waste Utilization, Code 633.

Precautions (fencing and warning signs) shall be used where necessary to ensure that the facility is not used for purposes incompatible with the facility modification.

**Erosion and Pollution Control.** All disturbed areas shall be re-vegetated or treated with other suitable measures used to control erosion and restore the aesthetic value of the site. Sites, not suitable for re-vegetation through normal cropping practices, shall be vegetated in accordance with NRCS Conservation Practice

Conservation practice standards are reviewed periodically and updated if needed. To obtain the current version of this standard, contact your Natural Resources Conservation Service [State Office](#) or visit the [Field Office Technical Guide](#).

**NRCS, WA  
January 2013**

Standard, Critical Area Planting, Code 342.

**Liquid and Slurry Waste Removal.** Liquid and slurry wastes shall be agitated and pumped to the maximum extent practicable. Water shall be added as necessary to facilitate the agitation and pumping. The wastewater shall be utilized in accordance with NRCS Conservation Practice Standard, Nutrient Management, Code 590 and/or Waste Utilization, Code 633.

**Sludge Removal.** During sludge removal operations, the integrity of the liner, if one is present, shall be maintained. Sludge shall be removed to the maximum extent practicable and utilized in accordance with NRCS Conservation Practice Standard, Nutrient Management, Code 590 and/or Waste Utilization, Code 633.

**Impoundment Closure.** Three options are associated with the decommissioning of liquid waste impoundments. One of the following will be used.

1. Embankment Impoundments (those with a depth of water at the design water level of three feet or more above natural ground) may be breached so that they no longer impound water. The embankment material can then be graded into the impoundment area, and the area vegetated for another use. Or the embankment may remain if the impoundment area surface has been sufficiently cleaned so that runoff leaving the site would not be considered as contaminated by the wastes.
2. Excavated Impoundments may be backfilled so that these areas may be reclaimed for other uses.
3. Impoundments may be converted to fresh water storage.

Embankment Impoundments. Waste and sludge shall be removed from the impoundment before the embankment is breached. Concrete and flexible membrane liners shall be removed or rendered unable to impound water and properly disposed of. The slopes and bottom of the breach shall be stable for the soil material involved, however the side slopes shall be no steeper than three horizontal to one vertical (3:1).

Excavated Impoundments. Concrete and flexible membrane liners shall be removed or rendered unable to impound water and properly disposed of. The backfill height shall exceed the

height to the design finished grade by a minimum of 5 percent to allow for settlement. The top one foot of the backfill shall be constructed of the most impervious soil material readily available and mounded to shed rainfall runoff. Incorporate available topsoil where feasible to aid establishment of vegetation.

Conversion to Fresh Water Storage. The converted impoundment shall meet the requirements as set forth in the appropriate NRCS practice standard for the intended purpose. Where the original impoundment was not constructed to meet NRCS standards, the investigation for structural integrity shall be in accordance with National Engineering Manual (NEM) 501.23. When it is not practical to remove the sludge from a waste impoundment that is being converted to fresh water storage, the impoundment shall not be used for fish production, swimming, or livestock watering until the water quality is adequate for these purposes.

**Fabricated Liquid Waste Facilities.** If fabricated structures are to be demolished, disassembled or otherwise altered, it shall be done to such an extent that no water can be impounded. Disassembled materials such as pieces of metal shall be temporarily stored in such a manner that they do not pose a hazard to animals or humans until their final disposition.

Demolished materials shall be buried on-site or moved off-site to locations designated by state or local officials. If buried on-site, the materials are to be covered with soil to a settled depth of at least one foot. The backfill height shall exceed the height to the design finished grade by a minimum of 5 percent to allow for settlement, and the backfill be sufficiently mounded such that runoff will be diverted from the site after the backfill settles.

**Dry Waste Storage or Treatment Facilities.** The soil at dry waste facilities such as confined animal housing, feedlots, livestock yards, or composting facilities with earthen floors must be evaluated.

The evaluation shall include laboratory analyses of the soil profile for any nutrients for which specific information is needed to determine the required depth of rehabilitation. Soil samples shall be taken at multiple locations and depths within the facility. One sample per depth interval per acre of the area being decommissioned with a minimum of 3 samples per depth interval shall be taken. Samples taken for each specified

sampling depth interval may be consolidated into a single set (e.g., 3 samples taken at the 0 to 6 inch depth interval may be consolidated into a single sample for testing). The samples shall be collected, prepared and tested in accordance with NRCS Conservation Practice Standard, Nutrient Management, Code 590.

The results of the soil analysis will be used to prepare a plan to recover the site for its intended use. The following site appropriate options shall be utilized, if needed:

- Adjust pH to restore desired crop growing conditions
- Plant salt tolerant plants to restore the site to desired crop conditions. The harvested vegetation quality should be monitored for N, P, and K removal.
- Select plants and erosion control practices to minimize phosphorus transport from the site and facilitate remediation of excessively high phosphorus levels.

Although in-situ processes are the preferred method for adjusting the soil conditions, removal of a portion of the soil may be necessary. The removed soil shall be land applied in accordance with NRCS Conservation Practice Standard, Nutrient Management, Code 590 and/or Waste Utilization, Code 633. Excavated areas shall be graded and or backfilled to shed rainfall and prevent ponding of runoff. Where feasible, available topsoil should be used to aid the establishment of permanent vegetation.

## CONSIDERATIONS

Conduct pre-closure soil and water (surface and subsurface) testing to establish base line data surrounding the site at the time of closure. Establishing baseline data can be used in the future to address soil and water issues.

Where the surface is covered by a dense mat of floating vegetation, pumping effort to empty waste impoundments may be reduced by first applying herbicide to the vegetation and then burning the residue. Appropriate permits must be obtained before burning. When burning is conducted, take necessary actions to ensure that smoke is managed to minimize impacts to downwind populations.

Alternative methods of sludge removal may be required where the impoundments contain large

amounts of bedding, oyster shells, soil, or other debris.

Minimize the impact of odors associated with land applying dry wastes and with agitation, emptying, and land applying wastewater and sludge from a waste impoundment by conducting these operations at a time when the humidity is low, when winds are calm, and when wind direction is away from populated areas. Adding chemical and biological additives to the waste prior to agitation and emptying can reduce odors. Odor impacts from land application can also be mitigated by using an incorporation application method.

Minimize agitation of the wastes to only the amount needed for pumping to reduce the potential for release of air emissions.

Soil to fill excavated areas should not come from important farmlands (prime, statewide, local, and/or unique).

Waste facility closure may improve utilization and aesthetics of the farmstead.

Breached embankments may detract from the overall aesthetics of the operation. Embankments should be removed and the site returned to its original grade.

Disassembled fabricated structures may be suitable for assembly at another site. Care should be taken during closure to minimize damage to the pieces of the facility, particularly coatings that prevent corrosion of metal pieces.

Measures should be taken during contractor's activities to minimize site erosion and pollution of downstream water resources. This may include such items as silt fences, hay bale barriers, temporary vegetation, and mulching.

To minimize potential impacts to livestock, such as nitrate poisoning, initiate a testing and monitoring program of nutrient levels in crop products, particularly livestock feeds, harvested from sites of closed animal confinement facilities.

## PLANS AND SPECIFICATIONS

Plans and specifications for the decommissioning of abandoned waste facilities and the rehabilitation of contaminated soil shall be in keeping with this standard and shall describe the requirements for applying the

practice to achieve its intended purpose. At a minimum, include the following:

1. A plan view showing the location and extent of the practice.
2. Pertinent elevations of the closed facility and excavation limits.
3. Number, capacity, and quality of facility(ies) and estimate of soil volume to be moved.
4. Location of known utilities.
5. Requirements for salvage and disposal of structural materials.
6. Vegetative requirements.
7. Utilization Plan for animal wastes and soil.
8. Odor management or mitigation requirement.
9. Safety plan requirements. Note: Per Occupational Safety and Health Administration (OSHA) confined space entry protocol, personnel shall not enter confined space of an enclosed waste facility without

breathing apparatus or taking other appropriate measures.

#### **OPERATION AND MAINTENANCE**

The proper decommissioning and rehabilitation of a waste facility should require little or no operation and maintenance. However, if it is converted to another use, such as a fresh water facility, operation and maintenance shall be in accordance with the needs as set forth in the appropriate NRCS conservation practice standard for the intended purpose.

#### **REFERENCES**

Rice, J.M., D.F. Caldwell, and F.J. Humenik. Ed. 2006. Closure of Earthen Manure Structures in Animal Agriculture and the Environment: National Center for Manure and Animal Waste Management White Papers, pp. 263-282. ASABE. Pub. Number 913C0306.





**APPENDIX I**

**WA NRCS Conservation Practice Standard No. 521A  
Pond Sealing or Lining - Flexible Membrane**

**NATURAL RESOURCES CONSERVATION SERVICE  
CONSERVATION PRACTICE STANDARD**

**POND SEALING OR LINING - FLEXIBLE MEMBRANE**

(No.)

CODE 521A

**DEFINITION**

A manufactured hydraulic barrier consisting of a functionally continuous layer of synthetic or partially synthetic, flexible material.

**PURPOSE**

To restrict, impede, and control seepage of water and contaminants from water and waste impoundment structures for water conservation and environmental protection.

**CONDITIONS WHERE PRACTICE APPLIES**

On ponds and water storage structures that require treatment to control seepage rates within acceptable limits.

On earthen waste storage ponds or lagoons and other waste impoundment structures that require treatment to control seepage of contaminants from the storage structure.

**CRITERIA**

**Design.** Structures to be lined shall be constructed to meet all applicable NRCS standards. All inlets, outlets, ramps, and other appurtenances may be installed before, during, or after the liner placement, but shall be done in a manner that does not damage or impair the proper operation of the liner.

Design and installation of the flexible membrane shall be in accordance with manufacturer recommendations. All flexible membrane installations shall be certified by the installer or manufacturer as meeting the material and installation requirements of the plans and specifications.

Manufacturer recommendations shall be followed with regard to protection from weather and exposure.

**Liner Materials.** Flexible membrane liner materials shall meet the requirements of the specifications indicated in the following tables:

Minimum Geomembrane Thickness Criteria		
Type	Minimum Thickness	
	Wastewater	Clear Water
HDPE	40 mil	30 mil
LLDPE	40 mil	30 mil
LLDPE-R	36 mil	24 mil
PVC	40 mil	30 mil
EPDM	45 mil	
FPP	40 mil	30 mil
FPP-R	36 mil	24 mil
PE-R	NR	24 mil

Minimum Bentonite Content for Geosynthetic Clay Liners		
Type	Minimum Bentonite Content	
	Wastewater	Clear Water
GCL	0.75 lb/sq. ft.	

Reference Specifications for Geomembranes	
Type	Applicable Specification
HDPE	NRCS Mtl. Spec. 594, Geomembrane Liner
LLDPE	
LLDPE-R	
PVC	
EPDM	
FPP	
FPP-R	
PE-R	

Conservation practice standards are reviewed periodically and updated if needed. To obtain the current version of this standard, contact your Natural Resources Conservation Service [State Office](#) or visit the [Field Office Technical Guide](#).

**NRCS, WA  
January 2013**

Reference Specifications for Geosynthetic Clay Liners	
Type	Applicable Specification
GCL	NRCS Material Specification 595, Geosynthetic Clay Liner

1 mil = 1/1000 of an inch

HDPE – High Density Polyethylene Geomembrane

LLDPE – Linear Low Density Polyethylene Geomembrane

LLDPE-R – Reinforced Linear Low Density Polyethylene Geomembrane,

PVC – Polyvinyl Chloride Geomembrane

EPDM – Ethylene Propylene Diene Terpolymer Geomembrane

FPP – Flexible Polypropylene Geomembrane

FPP-R – Reinforced Flexible Polypropylene Geomembrane

PE-R – Reinforced, Slit –Film, Woven Polyethylene Geomembrane

NR – Not Recommended

GCL – Geosynthetic Clay Liner

NRCS – Natural Resources Conservation Service

**Cover Soil.** PVC and GCL liners shall be covered with a minimum of 12 inches of soil measured perpendicular to the finished surface. Cover soil may be used on other liners but is not required unless essential for the proper performance, protection and durability of the installation. Cover soils shall not contain sharp, angular stones or any objects that could damage the liner. Maximum allowable particle size of soil cover material shall be 3/8-in for geomembrane liners and 1/2-inch for geosynthetic clay liners, unless the liner is protected by a 10-oz/sq yd or heavier non-woven geotextile cushion material. Cover materials shall be stable against slippage down the slope under all operational and exposure conditions, such as rapid drawdown or saturation by precipitation or snowmelt.

Cover soil shall be placed within 24 hours after placement of the liner to minimize the potential for damage from various sources, including precipitation, wind, and ultra-violet exposure.

GCL liners shall have a uniform confinement pressure as recommended by the manufacturer, which shall not be compromised by the presence of a drainage layer or venting system under the liner.

**Subgrade Preparation.** Subgrade preparation shall conform to manufacturer recommendations

and applicable state regulations. Subgrade materials shall not contain sharp, angular stones or any objects that could damage the liner or adversely affect its function unless a cushion layer is used.

**Cushion.** A cushion layer shall be placed beneath the liner if the subgrade particles contain sharp angular stones that could damage the liner or particles greater than 3/8-inch for geomembrane liners and 1/2-inch for GCL's. The cushion may be a 10-oz/sq yd or heavier non-woven geotextile or a layer at least 6 inches thick of soil meeting the particle size and shape requirements of the subgrade. Geotextile cushion material shall meet the requirements of GRI Test Method GT12(a). Follow the manufacturer's recommendations for any additional protective measures.

**Anchorage.** Liners shall be anchored to prevent uplift due to wind or slippage down the side slope.

**Safety.** Design shall include appropriate safety features to minimize the hazards of the structure. Warning signs, fences, ladders, ropes, bars, rails, and other devices shall be provided, as appropriate, to ensure the safety of humans and livestock.

#### **Underliner Drainage and Venting.**

Subsurface conditions such as soil type and groundwater levels will dictate the direction and scope of the design of the drainage and venting system beneath the geomembrane liner. An inadequate drainage and venting system may result in floating of the geomembrane liner. Hydrostatic pressures from fluctuating groundwater levels or leakage through the liner may cause the liner to float. Gas production and buildup beneath the liner due to the presence of organic material in the soil or leachate leakage through the liner may cause "whales" or bubbling of the liner.

**Groundwater and Leakage Drainage.** If the groundwater level may be near the invert elevation of the pond, groundwater monitoring should be conducted during the site investigation to verify the expected water table location. In some situations, it may be necessary to install groundwater monitoring wells for a year or more to determine the ground water levels and gather enough information to properly determine the required flow capacity of the drainage system. If high water tables could adversely affect the

proper functioning of the structure, interceptor or relief-type drainage systems should be included to control uplift pressures. Leakage through the liner due to liner damage should also be considered. Giroud and Bonaparte (1989) recommend designing the drainage system based on a frequency of one hole (0.16 in<sup>2</sup>) per acre of surface area.

**Gas Venting.** The need for venting for wastewater pond liners shall be investigated as part of the design. Site conditions which may be conducive to gas production include sites which have been subject to long-term seepage of animal waste into the foundation soil, sites with naturally occurring organics in the soil, or fine grained foundation soils where fluctuating groundwater levels may trap gases present in the soil. Venting of wastewater pond liners may not be required if other site conditions exist to allow dissipation of gas pressure from beneath the liner. One such condition is the presence of clean granular foundation soils (SW, SP, GW or GP).

**Drainage and Venting System Design.** The use of a geosynthetic such as a geonet or geocomposite under the liner to facilitate collection, drainage of liquids and venting of gas should be considered. If drainage and/or venting is needed, the geocomposite manufacturer's recommendations shall be followed in the system design. The allowable flow rate of the geocomposite shall be determined in accordance with GRI Standard GC8. The pond bottom should be sloped, typically a minimum of 1 percent, to permit positive flow of the liquids or gases. In most cases, the geocomposite will serve both purposes of drainage and venting. In large impoundments, the bottom may need to be sloped in multiple directions in order to decrease the required drainage and venting flow travel distances.

## CONSIDERATIONS

The number of penetrations through the liner should be minimized. Trenching and backfilling of fill pipes should be detailed such that charging of the underside of the liner with subsurface water is prevented.

For GCL liners, wastewater and subgrade and cover soils should be analyzed to ensure that undesirable cation exchange (calcium and/or magnesium for sodium) will not occur in the GCL.

A leak detection system is recommended beneath all liners, especially geomembranes.

If agitation operations may result in abrasion or other mechanical damage to the liner, then protective measures should be provided as needed to ensure the integrity of the liner, such as increasing the liner thickness above the minimum values indicated above or providing protective ramps and aprons at agitation locations.

## PLANS AND SPECIFICATIONS

Plans and specifications shall be prepared for specific field sites in accordance with this standard and shall describe the requirements for applying the practice to achieve its intended uses.

As a minimum, the plans and specifications shall provide the following:

1. Layout of the containment structure, collection points, waste transfer locations or pipelines, and topography of the site
2. Required liner properties, cushion materials, and pipeline materials
3. Subgrade details, including tolerances on smoothness of the finished grade
4. Details of liner installation, seaming requirements, and requirements for attachments and appurtenances
5. Minimum qualifications of installers
6. Warranty requirements, if desired
7. Quality control testing requirements
8. Fence and signage requirements, if required.

## OPERATION AND MAINTENANCE

A plan for operation and maintenance (O&M) of the liner and structure shall be prepared. The plan shall be consistent with the purposes of the type of liner chosen, intended life, safety requirements and design criteria. The plan shall contain requirements including but not limited to:

1. Design capacity and liquid level of the structure.
2. A description of the normal operation, safety concerns and maintenance requirements.
3. Monitoring procedures for leak detection systems, including alarm level leakage rates and actions to be taken if these rates are exceeded.

**NRCS, WA**

**January 2013**

521A - 4

4. Repair procedures.
5. Periodic inspection of the following:
  - Visible portions of the liner for tears punctures, or other damage;
  - Liner interface with inlets, outlets, ramps, or other appurtenances for damage;
  - Liquid level in the structure;
  - Ballooning of the liner indicating presence of gas beneath the liner.

## REFERENCES

ASTM D 5887-09, Test Method for Measurement of Index Flux Through Saturated Geosynthetic Clay Liner Specimens Using a Flexible Wall Permeameter

ASTM D 5890-06, Test Method for Swell Index of Clay Mineral Component of Geosynthetic Clay Liners

ASTM D 5891-02(2009), Test Method for Fluid Loss of Clay Component of Geosynthetic Clay Liners

ASTM D 5993-99(2009), Test Method for Measuring of Mass Per Unit of Geosynthetic Clay Liners.

ASTM D 6102-06, Guide for Installation of Geosynthetic Clay Liners.

ASTM D 6214-98(2008), Test Method for Determining the Integrity of Field Seams Used in Joining Geomembranes by Chemical Fusion Methods.

ASTM D 6392-08, Test Method for Determining the Integrity of Nonreinforced Geomembrane Seams Produced Using Thermo-Fusion Methods.

ASTM D 6497-02(2010), Guide for Mechanical Attachment of Geomembrane to Penetrations or Structures.

ASTM D 7176-06, Specification for Non-Reinforced Polyvinyl Chloride (PVC) Geomembranes Used in Buried Applications.

ASTM D 7272-06, Test Method for Determining the Integrity of Seams Used in Joining Geomembranes by Pre-manufactured Taped Methods.

ASTM D 7408-08, Specification for Non Reinforced PVC (Polyvinyl Chloride) Geomembrane Seams.

ASTM D 7465-08, Specification for Ethylene Propylene Diene Terpolymer (EPDM) Sheet Used in Geomembrane Applications.

Koerner, R.M. 2005. Designing with Geosynthetics, 5th ed. Pearson Prentice Hall, Upper Saddle River, NJ.

Geosynthetic Research Institute, GRI Standard GC8, Standard Specification for Determination of the Allowable Flow Rate of a Drainage Geocomposite.

Geosynthetic Research Institute, GRI Test Method GT12(a) – ASTM Version, Test Methods and Properties for Nonwoven Geotextiles Used as Protection (or Cushioning) Materials.

Geosynthetic Research Institute, GRI Test Method GM13, Standard Specification for Test Methods, Test Properties and Testing Frequency for High Density Polyethylene (HDPE) Smooth and Textured Geomembranes.

Geosynthetic Research Institute, GRI Test Method GM17, Standard Specification for Test Methods, Test Properties and Testing Frequency for Linear Low Density Polyethylene (LLDPE) Smooth and Textured Geomembranes.

Geosynthetic Research Institute, GRI Standard GM18, Standard Specification for Test Methods, Test Properties and Testing Frequencies for Flexible Polypropylene Nonreinforced (fPP) and Reinforced (fPP-R) Geomembranes.

Geosynthetic Research Institute, GRI Test Method GM19, Standard Specification for Seam Strength and Related Properties of Thermally Bonded Polyolefin Geomembranes.

Geosynthetic Research Institute, GRI Test Method GM21, Standard Specification for Test Methods, Properties, and Frequencies for Ethylene Propylene Diene Terpolymer (EPDM) Nonreinforced and Scrim Reinforced Geomembranes.

Geosynthetic Research Institute, GRI Test Method GM25, Standard Specification for Test Methods, Test Properties and Testing Frequency for Reinforced Linear Low Density Polyethylene (LLDPE-R) Geomembranes.

Giroud, J.P., and R. Bonaparte. 1989. Leakage through liners constructed with geomembranes—Part 1. Geomembrane Liners.

**NRCS, WA**

**January 2013**



*In* Geotextiles and Geomembranes, vol. 8, pgs. 27–67.

Quality Assurance and Quality Control for Waste Containment Facilities, EPA/600/R-93/182, September 1993.

USDA-Natural Resources Conservation Service, National Engineering Handbook, Part 642, Specifications for Construction Contracts.



**APPENDIX J**

**WA NRCS Material Specification MS-222  
HDPE and LLDPE Flexible Membrane Liner**

UNITED STATES DEPARTMENT OF AGRICULTURE  
NATURAL RESOURCES CONSERVATION SERVICE

**MATERIAL SPECIFICATION**

**MS-222: “HDPE and LLDPE FLEXIBLE MEMBRANE LINER”**

222.1 SCOPE

This specification covers the quality of High Density Polyethylene (HDPE) and Low Linear Density Polyethylene (LLDPE) flexible liner, seams, gaskets, metal battens, embed channels, clamps, and sealant.

222.2 MATERIAL

*Liner*—The HDPE or LLDPE liner shall have a nominal thickness of 30 mils, 40 mils, or 60 mils as specified. The liner shall be manufactured to be suitable for use in either exposed or buried conditions. It shall conform to the requirements of this specification as shown in tables 222–1 through 222–4. It shall also meet the requirements shown on the drawings.

*Gaskets, metal battens, clamps, embed channels, and sealant*—Gasket material shall be neoprene, closed cell medium, 0.25 inch thick, with adhesive on one side, or other gasket material as approved by the liner manufacturer. Metal battens shall be 0.25 inch thick by 2 inches wide stainless steel. Clamps shall be 0.5-inch-wide stainless steel. Embed channel shall have the same properties as the liner. Sealant shall be General Electric Silicone, RTV 103, or equivalent.

222.3 HDPE and LLDPE liner properties

The HDPE or LLDPE liner shall be manufactured from virgin polymer material and shall meet the property values specified under tables 222–1 through 222–4 as applicable.

**Table 222-1** Requirements for smooth HPDE liner

Property	Test methods	Requirements*		
		30 mil	40 mil	60 mil
Density, g/cc	ASTM D 1505	0.940	0.940	0.940
Tensile properties	ASTM D 638 (type IV at 2 in/min)			
yield stress, lb/in		63	84	126
break stress, lb/in		114	152	228
yield elongation, %		12	12	12
break elongation, %		560	560	560
Tear resistance, lb	ASTM D 1004	21	28	42
Puncture resistance, lb	ASTM D 4833	54	72	108
Carbon black content, %	ASTM D 1603	2-3	2-3	2-3
Carbon black dispersion	ASTM D 5596	Cat 1-2	Cat 1-2	Cat 1-2
Seam properties	ASTM D 4437 (1 in wide at 2 in/min)			
shear strength, lb/in		60	80	120
peel strength, lb/in**		39/FTB	52/FTB	78/FTB

\* All values, unless specified otherwise, are minimum average roll values as reported for the test method.

\*\* Film tear bond: A failure of one of the bonded sheets by tearing prior to complete separation in the bonded area.

**Table 222-2** Requirements for textured HPDE liner

Property	Test methods	Requirements*		
		30 mil	40 mil	60 mil
Density, g/cc	ASTM D 1505	0.940	0.940	0.940
Tensile Properties	ASTM D 638 (type IV at 2 in/min)			
yield stress, lb/in		63	84	126
break stress, lb/in		45	60	90
yield elongation, %		12	12	12
break elongation, %		100	100	100
Tear resistance, lb	ASTM D 1004	21	28	42
Puncture resistance, lb	ASTM D 4833	45	60	90
Carbon black content, %	ASTM D 1603	2 - 3	2 - 3	2 - 3
Carbon black dispersion	ASTM D 5596	Cat 1-2	Cat 1-2	Cat 1-2
Seam properties	ASTM D 4437 (1 in wide at 2 in/min)			
shear strength, lb/in		60	80	120
peel strength, lb/in**		39/FTB	52/FTB	78/FTB

\* All values, unless specified otherwise, are minimum average roll values as reported by the specified test methods.

\*\* Film tear bond: A failure of one of the bonded sheets by tearing prior to complete separation in the bonded area.

**Table 222-3** Requirements for smooth LLDPE liner

Property	Test methods	Requirements*		
		----- nominal thickness ----- 30 mil	40 mil	60 mil
Density, g/cc	ASTM D 1505	0.915	0.915	0.915
Tensile properties	ASTM D 638 (type IV at 2 in/min)			
yield stress, lb/in		45	60	94
break stress, lb/in		128	170	255
yield elongation, %		13	13	13
break elongation, %		800	800	800
Tear resistance, lb	ASTM D 1004	17	22	33
Puncture resistance, lb	ASTM D 4833	51	68	102
Carbon black content, %	ASTM D 1603	2-3	2-3	2-3
Carbon black dispersion, %	ASTM D 5596	Cat 1-2	Cat 1-2	Cat 1-2
Seam properties	ASTM D 4437 (1 in wide at 2 in/min)			
shear strength, lb/in		44	58	90
peel strength, lb/in		37/FTB**	50/FTB	90/FTB

\* All values, unless otherwise specified, are minimum average roll values as reported for each test method

\*\* Film tear bond: A failure of one of the bonded sheets by tearing prior to complete separation in the bonded area.

**Table 222-4** Requirements for textured LLDPE liner

Property	Test methods	Requirements*		
		----- nominal thickness ----- 30 mil	40 mil	60 mil
Density, g/cc	ASTM D 1505	0.915	0.915	0.915
Tensile properties	ASTM D 638 (type IV at 2 in/min)			
yield stress, lb/in		44	58	87
break stress, lb/in		60	80	120
yield elongation, %		13	13	13
break elongation, %		350	350	350
Tear resistance, lb	ASTM D 1004	17	23	35
Puncture resistance, lb	ASTM D 4833	51	68	102
Carbon black content, %	ASTM D 1603	2-3	2-3	2-3
Carbon black dispersion, %	ASTM D 5596	Cat 1-2	Cat 1-2	Cat 1-2
Seam properties	ASTM D 4437 (1 in wide at 2 in/min)			
shear strength, lb/in		40	53	79
peel strength, lb/in		33/FTB**	44/FTB	66/FTB

\* All values, unless otherwise specified, are minimum average roll values as reported for each test method

\*\* Film tear bond: A failure of one of the bonded sheets by tearing prior to complete separation in the bonded area.





**APPENDIX K**

**WA NRCS Material Specification MS-223  
Geosynthetic Clay Liner**

UNITED STATES DEPARTMENT OF AGRICULTURE  
NATURAL RESOURCES CONSERVATION SERVICE

**MATERIAL SPECIFICATION**  
**MS-223: “GEOSYNTHETIC CLAY LINER”**

223.1 SCOPE

This specification covers the quality of geosynthetic clay liner (GCL) material and workmanship.

223.2 MATERIAL

The GCL is composed of a layer of high shrink-swell sodium bentonite sandwiched between a layer of 6 ounces per square yard nonwoven polypropylene geotextile and a layer of 3.2 ounces per square yard woven geotextile. The GCL material shall be manufactured by one of the following processes:

- Needle punched process by which the bentonite is encapsulated between the geotextile layers by a mechanical bonding process without the use of any chemical binders or adhesive, or
- Lock stitched to provide internal shear strength and the integrity and consistency to the thickness and unit weight of the material.

The bentonite shall have the following base properties:

- A minimum of 0.75 pound per square foot of high shrink/swell sodium bentonite at 12 percent moisture. If the liner material is manufactured at higher moisture content, it shall still meet the above requirements when adjusted to the 12 percent moisture level.
- Swell index—minimum 24 ml per 2 grams.
- Fluid loss—maximum 18 ml

The GCL shall have an index flux value no larger than  $1 \times 10^{-8}$  m/s

223.3 PACKAGING AND LABELING

All material shall be packaged in individual rolls of a minimum of 3.65 meters wide and with at least 30.5 meters in length on the roll. All rolls shall be labeled and in a wrapping that is resistant to UV light deterioration. The labels on each roll shall identify the length and width of the roll, the manufacturer, the product, lot number, and the roll number.

#### 223.4 TESTING AND QUALITY CONTROL

The following tests shall be performed and the results certified by the manufacturer:

Swell index	ASTM D 5890
Fluid loss	ASTM D 5891
Bentonite mass/unit area	ASTM D 5993
Index flux	ASTM D 5887
Mass/unit area, geotextile	ASTM D 3776



#### 223.5 INSPECTION AND ACCEPTANCE

No liner material shall be accepted for placement in the permanent works that has not been certified by the manufacturer as meeting all specified requirements. No liner material shall be accepted that exhibits any visible defects. The liner material shall be subject to quality assurance testing at any time before and during installation.





**Legend**

-  Proposed Well
-  Existing Monitoring Well

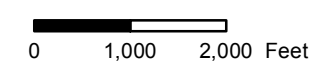
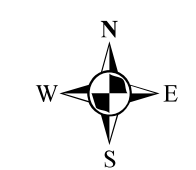

**PROPOSED WELLS**

*Yakima Valley Dairies*

Job#: CAFOM01	<b>FIGURE 1</b>
Date: 5/6/2015	
Path: M:\CAFOM01-Cow_Palace\1ProposedWells.mxd, Author: snicholls	





Project Memo

engineered**COMPOST**systems

DATE:	3/13/15	ECS PROJ. NO.:	P242
BY:	Tim O'Neill	PROJECT NAME:	Dolsen Dairy Compost Improvement
TO:	Levi Gassaway	COPY TO:	Adam Dolsen
SUBJECT:	Current Operations, Project Goals and Compost Pilot Overview		

RESPONSE REQUESTED:

Yes	<b>X</b>	No		Hard Copy		E-Mail	<b>X</b>	Phone Call	
-----	----------	----	--	-----------	--	--------	----------	------------	--

**Current Operations**

Currently the Cow Palace Dairy composts approximately 110,000 – 120,000 tons per year of straw manure in turned windrows on approximately 50 acres in the three areas shown outlined in red in the figure below. The majority of this material is generated during the four wet months of November through February when the cows shelter in the Loafing Sheds on straw bedding. An estimated average of 22,500 tons/month of straw manure produced during these months. The balance of straw manure is produced sporadically during the rest of the year during wet weather periods.



The compost produced the Cow Palace Dairy complies with WSDA and national guidelines for organic compost. This compost is broadly distributed to local agricultural customers for beneficial reuse.

## Project Goals

The high-level goals of this project are to improve the thermal/biological efficiency of the process so that finished compost can be produced more quickly. A shorter processing time will in turn allow the same annual tonnage to be processed in a smaller, more efficient area. ECS has helped other windrow composters improve efficiency by adding controlled aeration to their facilities. The likely reduction in the area required is between 40% – 70%.

The specific process goals are:

1. Meeting the time/temperature requirements posed by the WSDA guidelines.
2. Reducing the moisture in the product more quickly.
3. More rapidly producing a similarly stable material as the current process.
4. Reducing the particle size of the straw so the vast majority of the compost falls through as fines in the screening process.

## Compost Pilot System

The proposed pilot will measure the improvements gained by adding forced aeration and additional process control and monitoring to primary composting (first 2 – 6 weeks). This pilot will increase the Oxygen levels, speed up moisture removal, and provide temperature control. Controlling these process variables always improves the efficiency of the composting process. Every feedstock is however somewhat unique. The goal of the pilot is therefore to characterize how much additional efficiency is realistically possible.

The pilot program will use parametric testing to identify the best value approach for aeration rates, aeration periods, initial mix optimization, and how best to combine agitation (turning) and aeration.

The pilot system will provide controlled and repeatable rate of air flow through a temporary aeration floor. This floor will be designed to allow both static (un-turned) and agitated (turned) composting over the top of it. The system will have two zones that are 50 ft long x 14 wide (approximate volume 80 cy, weight 60 tons). A drawing of the pilot system is attached. The system will provide automatically controlled and monitored forced aerated composting in two zones. The control system will be linked to the Cow Palace office via a wireless network and connected to the web. This will enable management to track the testing, save data files, and change settings. This same connectivity will allow ECS direct access from Seattle to provide prompt support for training, tuning the system and optimizing operations.



## Initial Test Plan

The test plan outlined below should be considered as a starting point; these plans will evolve as more is learned about how the feedstocks respond to an aerated system. Also during a pilot program it is common to need to stop a test early, change some parameters, then re-run. The test period per batch will generally be between 10 – 40 days. Some feedstock characterization tests will also be required in addition to the data acquired by the automated control system. This will include density and moisture tests, and a few lab tests.

<b>Test #</b>	<b>1</b>	<b>Start-Up, Zone #1</b>	
		<i>Procedure</i>	<i>Goals</i>
		<ul style="list-style-type: none"> <li>Fill Zone #1 with as-received straw manure.</li> <li>Use default ECS aeration control settings</li> </ul>	<ul style="list-style-type: none"> <li>Check out system</li> <li>Discover straw manure's response to aeration/Tune control system</li> </ul>
<b>Test #</b>	<b>2</b>	<b>Start-Up, Zone #2</b>	
		<i>Procedure</i>	<i>Goals</i>
		<ul style="list-style-type: none"> <li>Fill Zone #2 with as-received straw manure.</li> <li>Use tuned aeration control settings</li> </ul>	<ul style="list-style-type: none"> <li>Check out system</li> <li>Measure un-amended straw manure's heat generating capacity and drying rate</li> </ul>
<b>Test #</b>	<b>3</b>	<b>Amended Mix Test #1</b>	
		<i>Procedure</i>	<i>Goals</i>
		<ul style="list-style-type: none"> <li>Fill zone with a mix of 10% dryer finished materials and the as-received straw manure.</li> </ul>	<ul style="list-style-type: none"> <li>Measure straw manure's heat generating capacity and drying rate after being lightly amended with finished product</li> </ul>
<b>Test #</b>	<b>4</b>	<b>Amended Mix Test #2</b>	
		<i>Procedure</i>	<i>Goals</i>
		<ul style="list-style-type: none"> <li>Fill zone with a mix of 30% dryer finished materials and the as-received straw manure.</li> </ul>	<ul style="list-style-type: none"> <li>Measure straw manure's heat generating capacity and drying rate after being modestly amended with finished product</li> </ul>
<b>Test #</b>	<b>5</b>	<b>Combined Turning &amp; Aeration #1</b>	
		<i>Procedure</i>	<i>Goals</i>
		<ul style="list-style-type: none"> <li>Fill Zone with as-received straw manure.</li> <li>Turn with WR turner every 3 days during the first 15 days</li> </ul>	<ul style="list-style-type: none"> <li>Measure the effect of combining aeration and turning on the heat generating capacity and drying rate of the as-received straw manure.</li> </ul>

<b>Test #</b>	<b>6</b>	<b>Combined Turning &amp; Aeration #2</b>	
		<i>Procedure</i>	<i>Goals</i>
		<ul style="list-style-type: none"> <li>• Fill Zone with as-received straw manure.</li> <li>• Turn with WR turner every 6 days during the first 18 days</li> </ul>	<ul style="list-style-type: none"> <li>• Measure the effect of combining aeration and turning on the heat generating capacity and drying rate of the as-received straw manure.</li> </ul>
<b>Test #</b>	<b>7</b>	<b>Super Aeration #1</b>	
		<i>Procedure</i>	<i>Goals</i>
		<ul style="list-style-type: none"> <li>• Fill Zone with as-received straw manure.</li> <li>• Put fan on maximum output for first 3 days of process, then return to automatic temperature control</li> </ul>	<ul style="list-style-type: none"> <li>• Measure the drying effect over aerating initially on the longer term heat generating capacity and drying rate of the as-received straw manure.</li> </ul>
<b>Test #</b>	<b>8</b>	<b>Super Aeration #2</b>	
		<i>Procedure</i>	<i>Goals</i>
		<ul style="list-style-type: none"> <li>• Fill Zone with as-received straw manure.</li> <li>• Put fan on maximum output for first 7 days of process, then return to automatic temperature control</li> </ul>	<ul style="list-style-type: none"> <li>• Measure the drying effect over aerating for a longer initial period on the longer term heat generating capacity and drying rate of the as-received straw manure.</li> </ul>

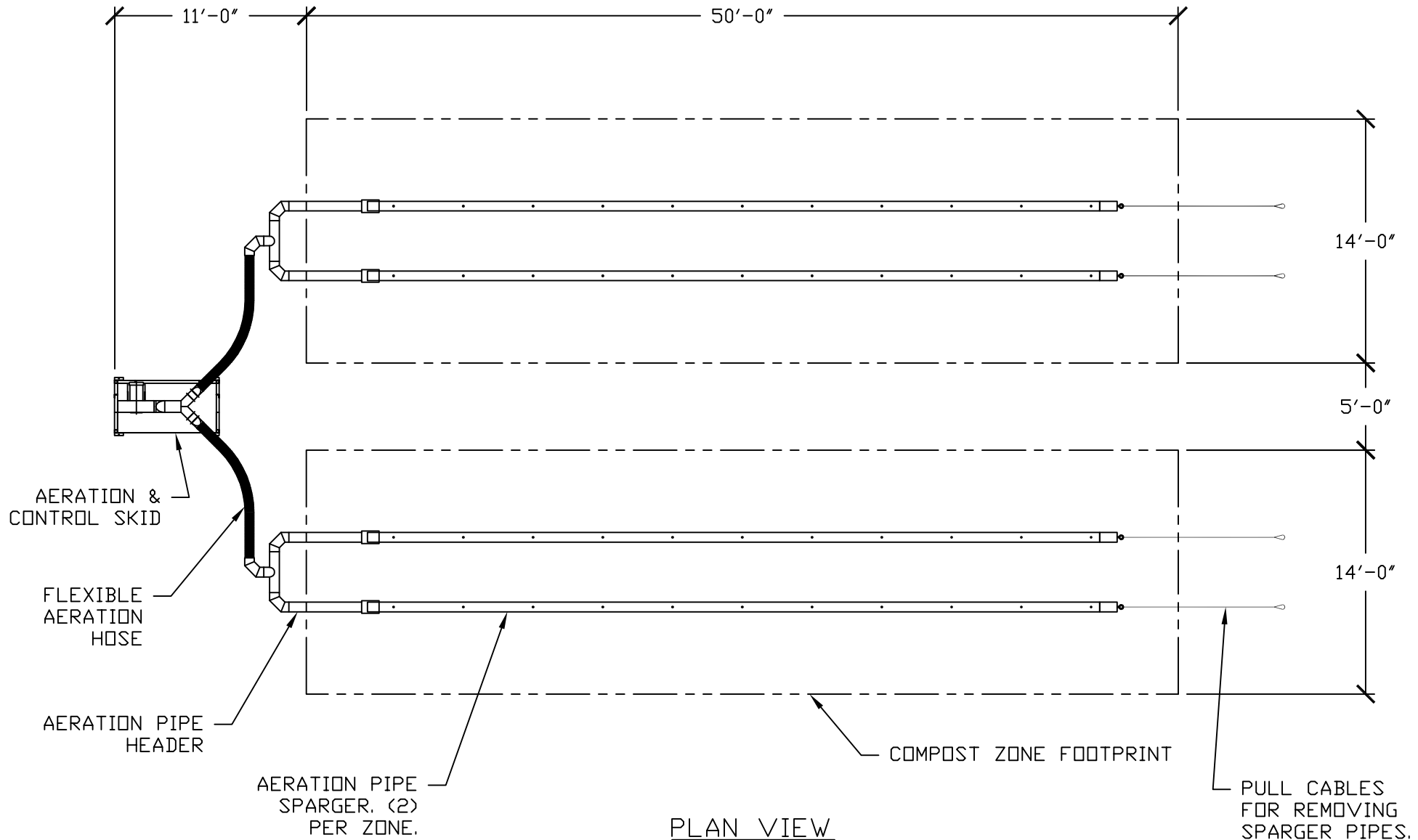

NO	REVISION	BY	DATE
-	-	-	-

**PROPRIETARY INFORMATION**  
 This drawing is the property of ECS and shall not be used, copied or reproduced in whole or in part, nor shall the contents be revealed in any manner to anyone unless written permission is obtained from Engineered Compost Systems, Inc.

ALL DIMS ARE IN INCHES  
DO NOT SCALE DRAWING

THIRD ANGLE PROJECTION

**ENGINEERED COMPOST SYSTEMS**  
 4211 24th Avenue West - Seattle, WA 98199  
 T 206.634.2625 F 206.634.1309 www.compostsystems.com

DRAWN: CJH	SIZE: A	TITLE: GENERAL SITE LAYOUT 2-Zone ASP	
CHCKD:		PROJECT: P242	SHT: 1 OF 2
DATE: 12 mar 2015		DWG. NO: 242-G01	REV: -
SCALE: 1/8"=1'			

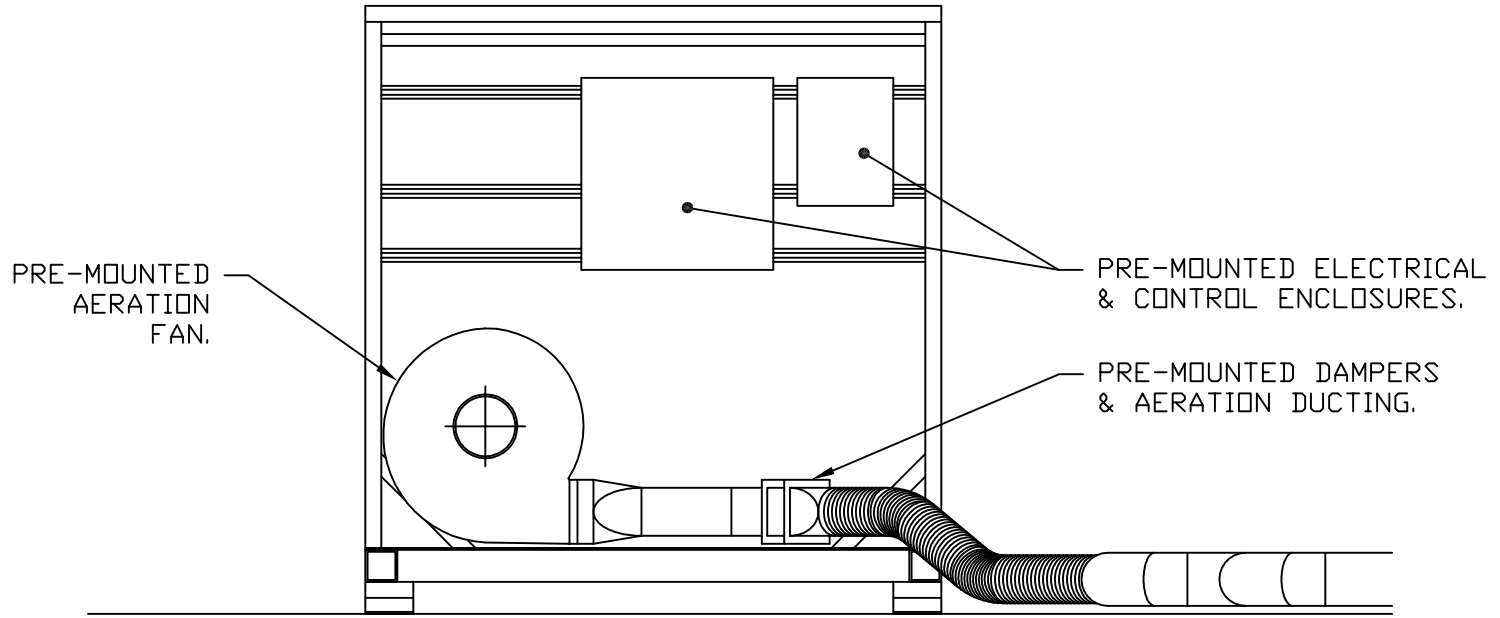

AERATION SKID ELEVATION  
SCALE: 1/2"=1'

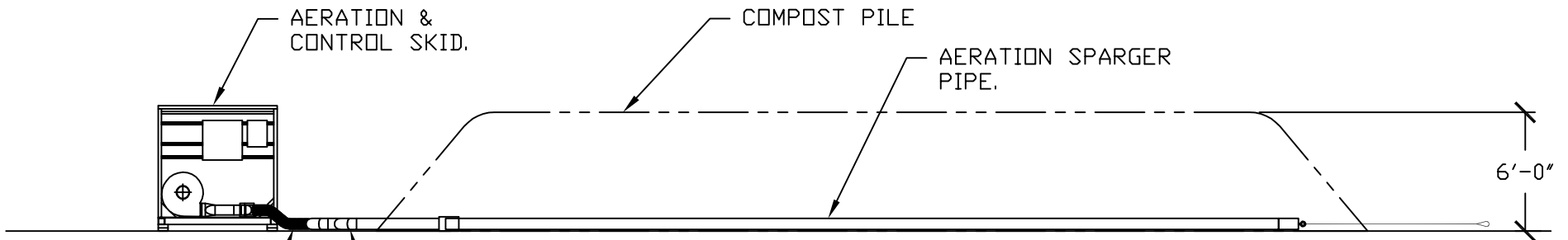

ELEVATION VIEW

NO	REVISION	BY	DATE
-	-	-	-

**PROPRIETARY INFORMATION**  
This drawing is the property of ECS and shall not be used, copied or reproduced in whole or in part, nor shall the contents be revealed in any manner to anyone unless written permission is obtained from Engineered Compost Systems, Inc.

ALL DIMS ARE IN INCHES  
DO NOT SCALE DRAWING

THIRD ANGLE PROJECTION

**ENGINEERED COMPOST SYSTEMS**  
4211 24th Avenue West - Seattle, WA 98199  
T 206.634.2625 F 206.634.1309 www.compostsystems.com

DRAWN: CJH	SIZE: A	TITLE: GENERAL SITE LAYOUT 2-Zone ASP	
CHKD:		PROJECT: P242	SHT: 2 OF 2
DATE: 12 mar 2015		DWG. NO: 242-G01	REV: -
SCALE: 1/8"=1'			

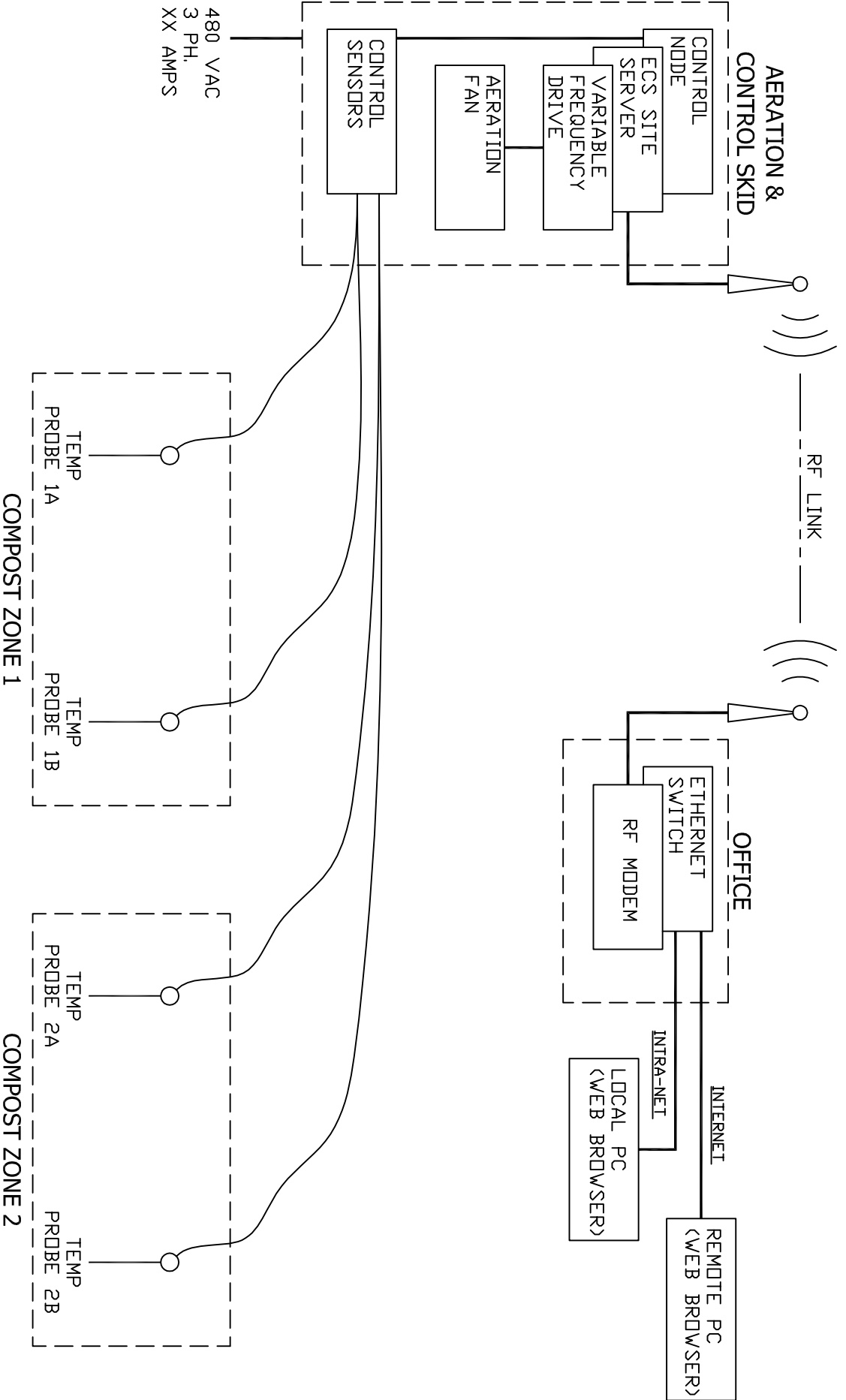

NO	REVISION	BY	DATE	ALL DIMS ARE IN INCHES DO NOT SCALE DRAWING				<b>ENGINEERED COMPOST SYSTEMS</b> 4211 24th Avenue West, Seattle, WA 98199 T 206.654.2625 F 206.654.1309 www.compostsystems.com	DRAWN: CJH	SIZE: A	TITLE: CONTROL SYSTEM DIAG. OVERVIEW
				DATE: 12 MAR 2015	PROJECT: P242				SHEET: 1 OF 1	SCALE: N/A	DWG. NO: 242-E01

PROPERTY OF INNOVATION  
 This drawing is the property of ECS and shall not be used, copied or reproduced in whole or in part without the contents be revealed in any manner to anyone unless written permission is obtained from Engineered Compost Systems, Inc.





## Cow Palace -- Annual Nitrogen and Phosphorus Budget Narrative Update (Draft)

**Date: March 10, 2015**

The following is a detailed and updated narrative and explanation on the use of the attached N and P budget. This narrative also attempts to address and provide input to some of the concerns presented by Bryon Shaw.

In its simplest form, a nutrient budget is based on the principle of conservation of mass and as an example can be defined as follows:

$$N_{\text{inputs}} - N_{\text{outputs}} = \Delta N_{\text{soil}} \text{ (Change in the soil N storage)}$$

However, careful thought and definition of the goals of any budget are necessary to help define what particular N or P pathways are being represented within the system. The goal of this budget is to provide a framework to which nitrogen and phosphorus can be evaluated within a manured agricultural system. The hope is that through documentation of the major inputs, outputs, and change in the soil that the N and P pathways that are unaccounted for will be minimized.

Under the current system of data collection, as defined by the AFMP and AOC, there will be a consistent documentation of data that will help to achieve quality budget evaluations. It is acknowledged that as this project moves forward, there may be some realized adjustments to attempt to make the budget more accurate.

### The Nitrogen Budget

The attached budget is set up on a crop year basis and is divided into 4 categories for nitrogen that include 1) soil inorganic N (measured nitrates and ammonium within the soil profile), 2) soil organic N (measured organic matter within the soil profile and a calculation of the nitrogen release from organic matter as well as that which is expected to mineralize from past manure applications or incorporated crop residues), 3) nitrogen applied, and 4) nitrogen removed from the harvested crop. All components of these categories are described below:

#### 1. Soil inorganic N (Columns B-G)

As defined by the AFMP, each sampling unit is soil sampled twice per year; once pre-plant in the spring and once post-harvest in the fall. Each field will be sampled at relatively the same time each year, which is favorable for use in the budget. Both nitrate ( $\text{NO}_3\text{-N}$ ) and ammonium ( $\text{NH}_4\text{-N}$ ) are a part of the required tests (Columns E and F).

2. Soil organic N (Columns H-L)

As a part of the AFMP, organic matter percent is also measured. The amount of mineralization from this organic matter fraction is estimated based on values from various literature sources, of which one is listed below. This estimated is based upon an equation where the value is multiplied against a fixed value of estimated N release on an annual basis (Columns H and I). In general, organic matter contains roughly 5% total nitrogen and of that portion, it is estimated that 1-2% of that nitrogen is released, or mineralized, each year. Therefore, a silt loam soil that weighs 3.5 million pounds that has an organic matter level of 3% would contain 105,000 pounds of OM and 5,250 lbs TN. If 1.5% of the TN was mineralized annually, then that would result in a total of 79 lbs available N per year. This results in a total of ~26 lbs N per percent of OM annually. For example, if the organic matter value is 3% for an alfalfa crop, then this value would be multiplied against a rate of ~26 lbs N release per percent of OM, for a total of 79 lbs N released for the year. It should be noted that organic matter release is much more complicated than this and is not linear in nature, but this will provide a repeatable, consistent approach to making estimations. Also, there is much literature on the reduction of organic matter mineralization rates and potential that is associated with conventional tillage and any sort of elevated salts, both of which are represented within these systems.

**Resource: USDA-NRCS, “Soil Organic Matter, Soil Quality Kit – Guides for Educators”**

Note: The literature in general provides a wide range of possibilities for mineralization. Mineralization is highly variable and hard to predict due to its complex interaction of the environment and specific soils.

If a crop is coming out of alfalfa or another legume, then, there will be a credit for the nitrogen that the crop will return to the system (Column K).

**Resource: “Nutrient Management for Field Corn Silage and Grain in the Inland Pacific Northwest”, PNW 615.**

Also, there is an additional component within manured systems where the organic nitrogen from past applications becomes available over time. This is accounted for through the calculations made as part of the report that is generated for determining available nitrogen within manures, called the “Ammonium-N Retention and Mineralization Report” (See attached example). This report is generated for all manures

that will be applied to sampling units which also includes an estimate for long-term availability for organic N (Column J).

**Resource: “Estimating Plant-available Nitrogen from Manure”, EM 8954-E, January 2008.**

3. Applied N (Columns M-O)

As defined in the AFMP and the DNMP, manures that will be applied to sampling units, must have a recent analysis so as to define the amount of nutrient, particularly N, that is present per a given volume or weight of product. This should also include a calculation of the amount of nitrogen that will be plant-available within the 1<sup>st</sup> year after application (Column O). All of these components are defined within the “Ammonium-N Retention and Mineralization Report”. This report is generated for all manures that will be applied to the sampling units and provide the necessary information for making a fertilizer rate recommendation. It also takes into consideration that some of the ammonia nitrogen will be lost to volatilization, which is estimated based upon the manure type and the application-incorporation dynamics.

**Resource: “Estimating Plant-available Nitrogen from Manure”, EM 8954-E, January 2008.**

4. Removed N (Columns P-U)

As also defined in the AFMP and the DNMP, crop yields will be recorded and maintained for a minimum of 5 years. This data is used both for making recommendation based off of realistic crop yield goals, as well as for determining the quantity of nutrient removed with the harvestable portion of the crop. These calculations will be based upon the USDA Crop Nutrient Removal Tool or by actual sampling of the crop plant material just prior to harvest to determine the actual amount of nutrient that is being removed (Columns P through U).

**Resource: USDA-NRCS Crop Nutrient Tool (<https://plants.usda.gov/npk/main>)**

While column V provides an analysis of the results of the inputs minus the outputs apart from that recorded as residual N within the soil, column W provides a calculation for the measured change in the soil inorganic N levels on an annual basis. These two columns will provide insight into the application and management decisions that affect the soil N budget and ultimately the amount of residual N within the soil profile.

While the nitrogen cycle is well understood, in practice, it is difficult to define within the construction of a nutrient budget. However, with the goal of using systematic data, that is already being generated as part of the AOC to populate and support the budget, this budget can provide valuable information for evaluating management processes with the goal of using system nitrogen efficiently and sustainably.

### **The Phosphorus Budget**

This budget is a simplified version of the nitrogen budget, which includes, the measured soil P level from the pre-plant and post harvest soil samples (Column D), the amount of P applied per acre (Column Y) based on the measured manure application (Column M) and the calculated P concentrations within the manure product (Column X), and the amount of P removed from the harvested portion of the crop (Column Z), as defined by the USDA Crop Nutrient Tool or by actual pre-harvest crop analysis.

Column AA represents the net balance between what was applied and what was extracted from crop uptake.

### **Look Up Tables and References**

Below is a list and description of the values that are utilized within the Look-Up portion of the budget.

- Rate<sub>1</sub> – Organic matter mineralization rates  
Rates are included that represent the inherent capability of the soil to mineralize nitrogen that will become available for plant uptake. If actual field measurements are simulated, or if rates are found to be different than the stated rates, then adjustments will be made.
- Rate<sub>2</sub> – Past manure mineralization rates  
By using the “Ammonium-N Retention and Mineralization Report” a 3 sample rolling average will be calculated as to what rate of release will be expected from past manure applications. This rolling average will help to provide some level of stability to the changes that may be observed from year to year.
- Rate<sub>3</sub> – Crop removal rate estimates (dry matter basis)  
As stated earlier, the crop removal rates will initially be based upon the USDA Crop Nutrient Tool Database. Pre-harvest samples of all crop types will be collected and analyzed so as to most accurately portray nutrient removal rates.

Other pertinent comments regarding the use of this budget:

- Agronomic rates will take rooting depth into consideration.
- The budget will be updated no less than annually.

- This budget is not a net sum “0” budget. There will be losses that are not defined.
- This budget is not proof of any specific amount of N loss.
- Crop removal rates will be calculated off of the harvested portion of the plant only. It is realized that the roots, stalks, and stems have taken-up nitrate and ammonium and transformed it into organic nitrogen.
- The phosphorus value measured in the soil is a value that represents that portion of the total phosphorus pool that is available to the plants for use. This value can vary significantly based on soil biology, soil temperatures, and other environmental factors. Therefore, any measureable change in soil values will have to be assessed over a longer period of time.
- Soil organic matter is also a relatively stable pool that will not change significantly over time, and therefore, any measureable change in soil values will have to be assessed over a longer period of time.

**Other concerns and discussion** (as per a phone conversation with Byron Shaw on 3/10/15):

Shaw discussed the following concerns:

1. What would be my approach to reduce both N and P within the field soils?

The AFMP, which is based upon the guidelines presented within the NRCS Code 590, requires that fertilizer (including manure) applications be based upon agronomic rates that consider all of the above mentioned nitrogen inputs. Including residual nitrogen within the application rate calculations will help to bring soil N levels down in that residual nitrogen is expected to be mostly used. While calculations are made with essentially a zero balance in mind, in practice, no soils will ever reach zero. However, overtime using this approach soil nitrate residual levels will drop. Through the use of lower application rates, the amount of nitrogen that is mineralized from past applications will decrease as well.

As part of the initial analysis of the manure management systems at Cow Palace, it was determined early on that a centrifuge or Dissolved Air Flotation Bed (DAF), would be an important tool to implement to both reduce nitrogen and phosphorus within the lagoon water that is typically used to apply to fields. Hence, within the next month or two, there will be a functioning centrifuge in place that will reduce nitrogen by a minimum of 30% and phosphorus by a minimum of 80% within the lagoon water at Cow Palace. Cow Palace already had relatively low phosphorus additions as part of their manure management system, but the centrifuge will reduce these levels even more. Therefore, even if Cow Palace makes agronomic applications on a nitrogen basis to fields, the phosphorus extracted by the crops being produced will always exceed that being added, resulting in a “draw-down” plan for phosphorus.



Shaw stated that he would like to see 15 ppm or less in the 2<sup>nd</sup> foot for nitrate and 20 ppm or less for the top foot for phosphorus. I do not necessarily agree with these values, but with the approach that is being used to manage applications, soil levels will be decreasing and moving towards these targets.

For nitrogen, I would be in favor of initially working towards achieving levels that are consistently below 45 ppm (the AOC standard), then stepping down to 35 ppm, then 25 ppm. However, even with well controlled agronomic applications, it should be realized that due to the varied nature of mineralization from organic matter and past manure applications, that very low values may not be able to be achieved every year. In my experience with working with both dairy and non-dairy growers, it is not plausible to expect that levels below 15 ppm would be able to be maintained. However, it should be noted that through careful water management, that these levels would be held within the profile and not lost. This is due to the nature of our environment where we only receive small amounts of rainfall within the winter months. This retained nitrogen would be available for late fall and winter uptake by the growing crops.

For phosphorus, I also do not agree with the proposed value as this level is half of what other states in the PNW are using as guidance. For example, Idaho has a standard of 40 ppm that is promoted. In addition, the NRCS Code 590 calls for the use of a Phosphorus Index that gives weight to risk as a result of current soil levels, environment, and soils. This index provides feedback on fields that may have higher risk for movement off-site. This data would be used to make evaluations and plans for each individual field. As also stated above, the current system will continue to result in the "draw-down" of phosphorus.

## 2. What sort of timeframe would I project to be able to reach the stated goals?

For nitrogen, this drop will occur fairly quickly as it is utilized at higher levels. On fields with higher residuals, I would expect to be down into the 25-30 ppm range, or lower, within a year or two for most, if not all, fields. Levels should continue to drop beyond that as well.

It should be realized that phosphorus levels will decline at a much slower rate than nitrogen as it is used at a much lower rate within the plant as compared to nitrogen. Even if no manure was applied to some of these fields for the foreseeable future, it will likely take 10-20 or more years to bring these levels down to mid-double digit values. Remember that many of these fields have had manure applications for 30 or more years. Also, the Irrigation Water Management Plan will help to reduce the potential for off-site movement.

## 3. What will be my approach to the timing of field manure applications?

In as much as it is possible, application will occur at times when there are actively growing crops in place. I agree and adhere to the principles outlined in the NRCS Code 590 guidelines in that applications should be avoided to soils that are saturated or frozen. Planned applications

also need to take into consideration weather events that have recently occurred or are forecast to occur within a couple days. With the implementation of a centrifuge and with proper lagoon management, it should become possible to avoid applications during winter months. The data collected from the irrigation sensors can also help to guide rates as soil moisture levels will be more easily assessed for each field.

4. What sort of strategies would be used to help control low or sensitive areas?

Many of the soil water sensors that are within the fields represent the lower portions of the fields. This was done on purpose to be sure that we are not over irrigating such areas. Also, additional agronomic practices have been discussed and will be implemented this season. One such practice is the use of a dammer-diker. This implement makes small depressions within the soil between the crop rows that help hold water in place, thus reducing water movement across the surface of the field (this is similar to soil imprinting). This practice is known to reduce soil erosion, reduce water use, reduce inputs, and typically increase yields.

I believe that this tool will help to reduce wetness to lower areas. However, if such issues do persist, then there remains the option to using some sort of buffer crop within the lower more sensitive zones.

Please call or email if there are any questions to the contents of this narrative.

Sincerely,

Scott Stephen  
Soil Scientist  
Agrimanagement, Inc.

Field CP-SU01

Acres

69.0

Annual Nitrogen and Phosphorus Budget (Draft)

See the Look Up tables for pertinent resources

[A]	[B]	[C]	[D]	[E]	[F]	[G]	[H]	[I]	[J]	[K]	[L]	[M]	[N]	[O]	[P]	[Q]	[R]	[S]	[T]	[U]	[V]	[W]	[X]	[Y]	[Z]	[AA]	
Crop Year	<u>Soil Sampling Data</u> (soil inorganic N)						<u>Mineralized Nitrogen</u> (soil organic N)					<u>Nitrogen Applied</u>			<u>Nitrogen Removed by Crops</u>					<u>Estimated N added (removed)</u>	<u>Calculated change in Soil N Residual</u>	Estimated Lagoon P Analysis	<u>Phosphorus Applied</u>	<u>Phosphorus Removed by Crops</u>	<u>Estimated P added (removed)</u>		
	Sample Date	Depth	P (ppm)	NO <sub>3</sub> -N lb/ac	NH <sub>4</sub> -N lb/ac	Total N Available lb/ac [D] + [E]	O.M. %	mineralization [H] x Rate <sub>1</sub>	Est. Past manure N [I] x Rate <sub>2</sub>	Estimated N Credits from previous crop	Total Estimated N [I] + [J] + [K]	Amount Applied (1000 gal)	Estimated Lagoon N (lbs/1Kgal)	Lbs N Applied [M] x [N] / Ac	Crop	Production (tons)	Yield (tons/ac)	moisture (%)	Revised Yield (Dry Matter Basis) (tons/ac)	Lbs N Removal [T] x Rate <sub>3</sub>	[L] + [O] - [U]	Δ [G]	(lbs/1Kgal)	[M] x [X] / Ac	(lbs/acre)	(lbs/acre)	[Y] - [Z]
2011											17280																
2012											7680																
2013											11400																
2014	10/5/2013	1	290	330	2	332	3.0%	30	53	0	83	612	3	29	Triticale	489.52	7.09	55%	3.19	150	(38)		0.48	4.26	43.99	(40)	
		2		254		254																					
		3		256		256																					
	3' Profile					842																					
	5/10/2014	1	264	112	4	116	2.7%	54			54	2562	3	123	Silage Corn	2113.69	30.63	68%	9.80	255	(78)		0.48	17.82	73.52	(56)	
		2		143		143																					
2015	10/5/2014	1	184	175	4	179	2.3%	23	51	0	74		3		Triticale												
		2	100	158	5	163	0.9%																				
		3	70	176	6	182	1.0%																				
	3' Profile					524																(318)					
2016																											



**Look Up Tables and References****Rate<sub>1</sub> - Organic matter mineralization**

30	lbs Mineralized N per % OM (Full season)
20	lbs Mineralized N per % OM (Summer season only)
10	lbs Mineralized N per % OM (Winter season only)

Values estimated from USDA-NRCS publication "Soil Organic Matter, Soil Quality Kit-Guides for Educators". Several other sources also support these values.

**Rate<sub>2</sub> - Past manure mineralization**

0.23	2 yr	lbs Mineralized N per 1000 gallons	This will be a 3 year rolling average
0.11	3 yr	lbs Mineralized N per 1000 gallons	
0.03	4 yr	lbs Mineralized N per 1000 gallons	

Values calculated from using the resource: "Estimating Plant-available Nitrogen from Manure", EM 8954-E, January 2008.

Assumes some level of Volatilization, as determined by the above document.

Applied Organic Nitrogen will not all be available for the current crop.

**Rate<sub>3</sub> - Crop Removal Rate Estimates (dry matter basis)**

	Nitrogen		Phosphorus
Triticale	47 lbs N/Ton		6.2 lbs P <sub>2</sub> O <sub>5</sub> /Ton
Silage Corn	26 lbs N/Ton		7.5 lbs P <sub>2</sub> O <sub>5</sub> /Ton
Sudan Grass	51 lbs N/Ton		8.2 lbs P <sub>2</sub> O <sub>5</sub> /Ton
Alfalfa	69 lbs N/Ton		6.8 lbs P <sub>2</sub> O <sub>5</sub> /Ton

Values taken from the USDA Crop Nutrient Tool Database (<https://plants.usda.gov/npk/main>). Actual "in-field" data will be taken in 2015 and used to populate this look-up table

For notes and comments pertaining to these rates and how they will be used, see Pages 3 and 4 of the Budget Narrative.

**AGRI MANAGEMENT INC.**<sup>®</sup>  
 AGRICULTURAL CONSULTANTS

*Measuring Crop Needs for Greater Profits*

# Ammonium-N Retention and Mineralization Report

## Report Details

**Cow Palace**  
 CP-LG01

**Date Sampled** Aug. 27, 2014  
**Sampled By** Stephen  
**Client Code** Y125  
**Job Code** 8362  
**Report Code** D14-0001  
  
**Laboratory** SoilTest  
**Lab Code** M14-00647  
**Sample Type** Liquid  
**Dry Matter** 0.3%  
**Fluidity** Lagoon Water  
**Density** 8.22 lbs/gal  
  
**Incorporation** 7 Days

## Notes & Observations

Sunny 78 degrees. Filled at 11:40.

## Sample Composition, Density Corrected

Element/Compound		ppm(mg/l)	lbs/1000gal	1Y Ret/Min	1Y Available
<b>Total N</b>	Nitrogen	443.25	3.70	76.82%	2.84
<b>NO<sub>3</sub>-N</b>	Nitrate	11.98	0.10	100.00%	0.10
<b>NH<sub>4</sub>-N</b>	Ammonium	283.68	2.37	95.00%	2.25
<b>Organic N</b>		147.59	1.23	40.00%	0.49
<b>P</b>	Phosphorus	30.53	0.25		
<b>P<sub>2</sub>O<sub>5</sub></b>	P Oxide	73.87	0.62	90.00%	0.55
<b>K</b>	Potassium	647.14	5.40		
<b>K<sub>2</sub>O</b>	K Oxide	777.16	6.49	90.00%	5.84
<b>S</b>	Sulfur			60.00%	
<b>Ca</b>	Calcium			100.00%	
<b>Mg</b>	Magnesium			100.00%	
<b>Na</b>	Sodium			100.00%	
<b>B</b>	Boron			100.00%	
<b>Zn</b>	Zinc			100.00%	
<b>Mn</b>	Manganese			100.00%	
<b>Fe</b>	Iron			100.00%	
<b>Cu</b>	Copper			100.00%	

## Long-term Availability for Organic N

Year(s)	1	2	3	4	5-9
<b>Mineralization</b>	40.00%	15.00%	7.00%	3.00%	2.00%
<b>Available</b>	0.49	0.18	0.09	0.04	0.02

## Other Results

<b>Total C</b>	Carbon (lbs)	
<b>C:N Ratio</b>		
<b>E.C. mmhos/cm</b>	Salt	
<b>pH</b>		

Available N values calculated from OSU EM 8954-E. Calculations by Agrimanagement, Inc.  
 Fertility and chemical data used to formulate a recommendation was processed and reported by Soil Test, Inc.



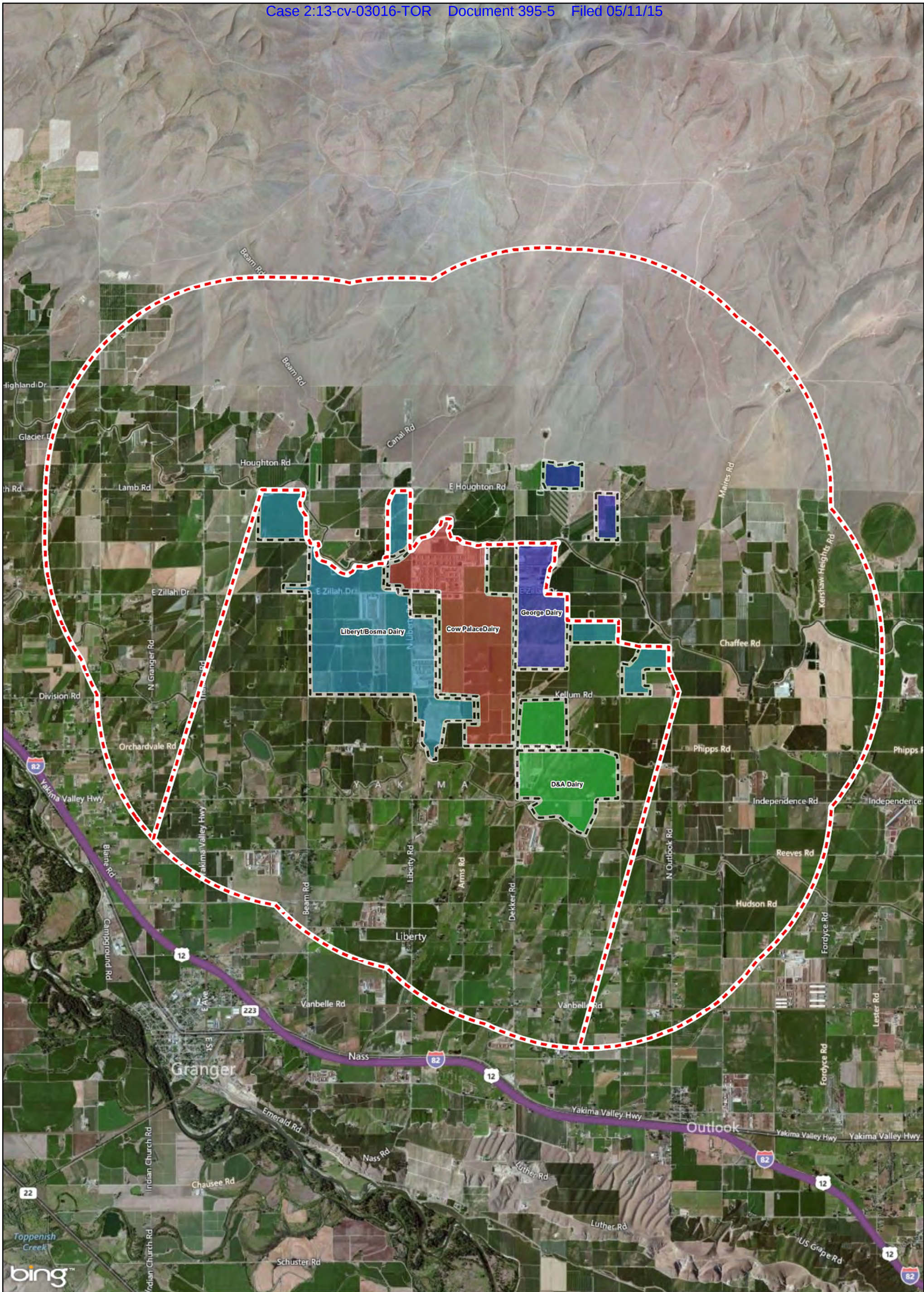

**Legend**

- 3 Mile Parcel Buffer
- Cow Palace 1 and 2 Dairy
- D&A Dairy
- DeRuyter Dairy
- Liberty/Bosma Dairy

Miles

0 0.5 1 2

**Radius Map - Approximately 3 Miles Downgradient of Daires**

---

Job#: \_\_\_\_\_

Date: 4/17/2015

FIGURE 1

M:\CAFOM01-Cow\_Palace\3mlebuffer.mxd